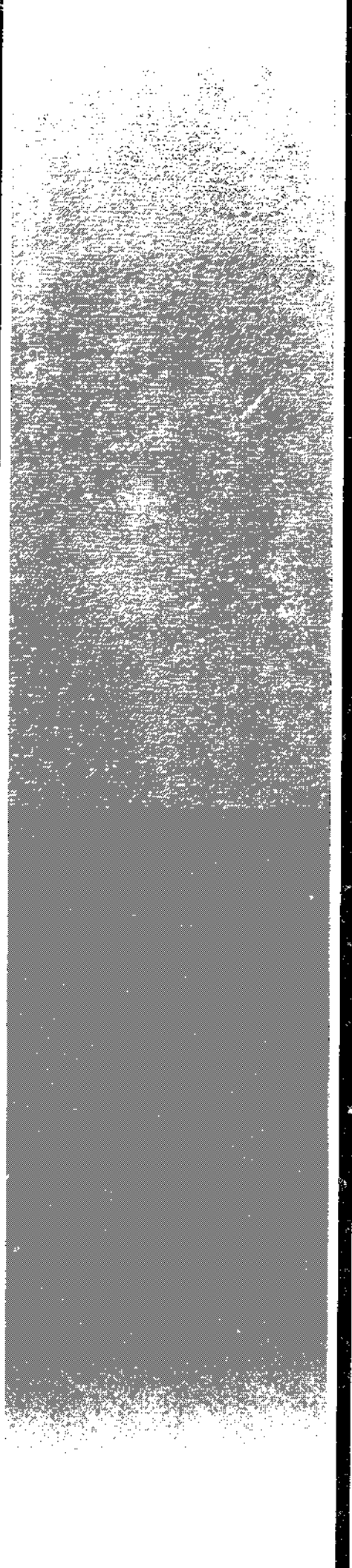


# ACCESSIBILITY STANDARDS

## ILLUSTRATED



CAPITAL DEVELOPMENT BOARD

DONALD S. GLICKMAN

STATE OF ILLINOIS

EXECUTIVE DIRECTOR

# The Capital Development Board

**Robert L. Donahue, Chairman**  
Markham

**Donald S. Glickman**  
Executive Director

**Michael Linz, Vice Chairman**  
Naperville

**Michael A. Landwirth, Secretary**  
Peoria

**Robert Oxtoby**  
Springfield

**George B. Peters**  
Aurora

(two vacancies)

**Third Floor, William G. Stratton Building**  
401 South Spring Street  
Springfield, Illinois 62706

**Suite 320, 180 North LaSalle Street**  
Chicago, Illinois 60601

**ACCESSIBILITY STANDARDS**  
**ILLUSTRATED**

EFFECTIVE DATE  
28 DECEMBER 1978

# **ACCESSIBILITY STANDARDS ILLUSTRATED**

**MICHAEL A. JONES ARIBA**

**JUNE 1978**

## INTRODUCTION

Each decade since the end of the First World War has seen an acceleration in the progress of medical science, the results of which have been an increase in the survival rate of victims of accident, disease and disability, plus an extension of the life span of the elderly and infirm. Current technology can enable disabled persons to be productive members of society. However, the vast majority of these people are denied the benefits of many resources because society is often unaware of the needs of the handicapped and the methods available to fulfill these needs. Much of our physical environment, including transportation, remains inaccessible to many citizens, despite state and federal legislation aimed at relieving the problems.

There are several reasons for the limited measure of success with existing accessibility legislation. Until recently, there was no explicit identification of the handicapped population or a comprehensive compilation of the types of problems encountered by them when using the built environment. The Illinois Revised Statutes, Chapter III, Section 12, had defined a handicapped person as one who is confined through disease or injury to a wheelchair all or part of the time. This was an extremely restricting definition and the Eightieth Session of the Illinois General Assembly saw fit to broaden it. Governor Thompson signed the expanded definition into law in September 1977 - P.A. 80-487, and it forms the basis for the requirements developed in this Standard. The definition of a handicapped person now includes those who are physically, or mentally disabled, or who have communication difficulties.

The problems of daily living which confront disabled people are only beginning to be identified in a thorough and systematic manner. Previously, only certain specific categories of disability had been examined and analyzed in any depth. For example, the problems of the blind and those in wheelchairs have received attention, but the solutions to their problems were, more often than not, developed in isolation, with little thought for their overall impact on the rest of society. Consequently, countermeasures, while solving problems for a specific group of people, have often resulted in the creation of difficulties and even potential hazards for other citizens. The proliferation of badly designed curb ramps throughout the country is an example of this. Similarly, devices to foil vandals introduced on coin-operated, automatic vending equipment have often impaired the functional efficiency of the design, which, as a result of these design changes, may not be used by persons possessing less than average strength or manipulative skills. Thorough research and testing would have produced a far better range of solutions in both cases.

The wording in handicapped standards is frequently ambiguous, and frequently recommendatory, making requirements difficult to implement. Words such as "should" and "may" must be changed to "shall", and the number of required items must be specified, and not left up to the decision of the designer or building official, which often happens when wording such as "appropriate number" or "amount deemed feasible" is used. Standard requirements for buildings are usually minimum requirements, and their use and application invariably achieves the most minimal results.

Local, regional, state and federal "handicapped standards" are not uniform, and contain numerous inadequacies and inconsistencies. This creates problems for members of the building professions, who are unaware of the many problems experienced by the disabled and who cannot relate to the issues that have generated the need for accessibility standards. Therefore, they may not be able to make the best decision when the solution is not obvious or there appears to be a conflict in the requirements.

Frequently, compliance and implementation of such requirements is identified erroneously with increased costs. Generally, the incorporation of accessibility standards at the earliest stages of the design process results in little or no increase in the construction budget.

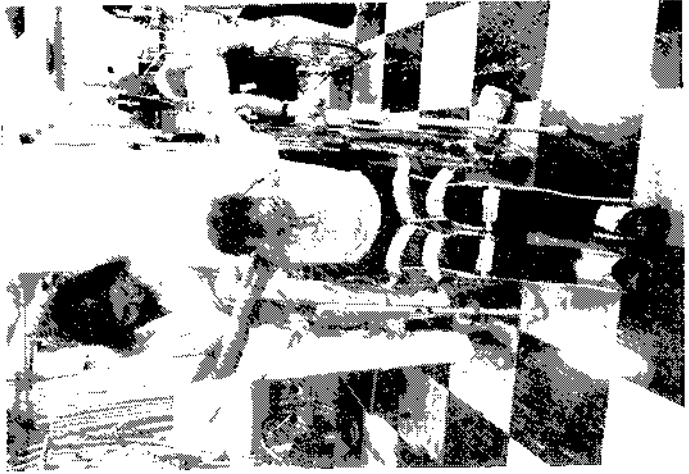
The 79th Illinois General Assembly, realizing the problems facing handicapped citizens and the inadequacy of the existing standards, mandated the Capital Development Board, in House Bill 984, to research and revise standards of minimum requirements for facilities for handicapped persons in public buildings. This document is the result of this mandate, and it has had the benefit of the most current research available in the country. Statewide input was obtained from handicapped people and building industry representatives through advisory panels set up by the Capital Development Board. Extensive public hearings also were held successfully in several parts of the State. All testimony was examined, and the standards were refined accordingly.

Developing an awareness of the problems of disabled people should produce a safer and more usable environment. The implementation of these "Accessibility Standards" will enable the elderly and handicapped to enjoy the right of access that the able-bodied population takes for granted as its natural right.

### CAPITAL DEVELOPMENT BOARD

**Donald S. Glickman**  
Executive Director





With the increase in the development of medical technology and rehabilitation medicine, those with the most severe traumatic injuries or congenital disabilities can be expected to lead, and will demand to lead full, productive lives given an accessible environment. . .

Photo: Rehabilitation Services Administration, Region 5, HEW

## FOREWORD

This Standard has been prepared in accordance with Public Act 79-978, an Act to amend Section 4 of "Facilities for the Handicapped Act"; approved June 4, 1965 as amended. (Effective Date October 1, 1975.)

The 1970 census figures for the United States indicated that there were 11,256,000 persons who were handicapped in the acceptable employable age range of 16-64 years old, or one in every eleven adult Americans. Not included in these figures are disabled confined to institutions. The census information also shows that there are eight states which account for half of all the adult handicapped people living in the United States, and Illinois is one of these.

About 1 out of every 7 non-institutionalized adults in Illinois is disabled, with approximately 1 in 20 of them severely disabled. It is estimated that 37,955 adults are mentally retarded, 577,573 are disabled and 318,470 adults are severely physically disabled. Statistics show that there are nearly 1,000,000 adult persons handicapped in Illinois. However, this figure is low because elderly people and children have not been included.

At each stage of the life cycle, there are normal and irreversible physical changes which are not related to accident or disease. As a person moves into old age, he experiences normal sensory changes. Generally, these changes or losses accelerate at the following ages: vision — age 50; hearing — age 40; touch — age 55; taste — between ages 55-59; and smell — after 70 years of age. They increase in severity with each decade after age 65, so that in the late 70's or early 80's, sensory deterioration may become quite serious. As with any aspect of aging, these sensory changes do not begin in everyone at the same age, nor do they occur simultaneously or to the same extent in each individual. Nevertheless, many elderly persons have difficulty using the built environment, as accident statistics show.

"Able-bodied" children are expected to behave, react and negotiate through an environment designed primarily for able-bodied adults. As with the elderly, statistics show that the accident rate for children, particularly as pedestrians, is above that of the general population. Their cognizance and reaction to the environment is not the same as that of mature adults and their smaller size handicaps them in a variety of activities.



If we consider that the environment has traditionally been designed for the average, "able-bodied" adult (of average height, weight, hearing, eyesight, stamina and reaction time), then the rest of the population which does not match up to this standard is, by definition, handicapped. It is estimated that nearly 60 percent of the total population of the United States is handicapped at any one time in their use of the environment. Any changes that are made to the environment to aid the severely handicapped population will also help all people to lead easier and safer lives. There are approximately 20 million accidents in and around the home per year, resulting in 110,000 permanent disabilities and 30,000 deaths. The Consumer Product Hazard Index ranks several architectural elements in the top twenty hazards. Stairs, ramps and landings rank second; floor and flooring materials rank fourteenth and architectural glass and glass doors rank sixteenth. While it is obvious that many disabled people are having problems with these elements, it is clear from the accident statistics that everyone is subject to hazards found constantly in buildings and allied facilities.

While the environment poses problems to all citizens, the effects of architectural barriers on the severely disabled are manifested more tragically. The handicapped population has less income, less education, less employment and more poverty. New federal and state legislation will, hopefully, rectify this situation. However, without more accessible schools and colleges, there are fewer educational opportunities; without more accessible businesses and factories, there are fewer employment opportunities; without accessible housing, there are few homes available to, and useable by disabled people. The climate has changed rapidly in the last few years, and legal pressures for changes to the inaccessible environment have been made at local, state and federal levels. The goal is to afford the disabled the opportunity to make the social and economic gains open to most citizens.

Opponents to accessibility legislation usually cite increased cost for the incorporation of barrier-free design requirements as the reason for their opposition. However, studies in Europe and America demonstrate that these increases are minimal. For new buildings and facilities, the most recent study in the United States indicates increases to the total project construction costs averages 0.48 percent for all building types, and 0.12 percent excluding housing. Renovation costs are higher, obviously, and average 4.02 percent increase for all buildings, but 0.54 percent excluding housing. Cost increases will vary from building to building, but when accessibility standards are incorporated in the initial design phase, they usually result in cost savings or only minimal increases.

These Standards have been produced using the results of research conducted throughout the United States. In order to minimize conflicts with future federal standards, the Capital Development Board's staff and several of its advisory panelists have served as advisors on the development of the proposed ANSIA 117.1 (1977) "Specifications for making buildings and facilities accessible to and usable by physically handicapped people," under contract at Syracuse University. The Illinois "Accessibility Standards" has mirrored, wherever possible, the proposed ANSI requirements, although at the date of publication of the Illinois Standards, ANSIA 117.1 (1977) still remains in draft form.

The Illinois "Accessibility Standards" has been produced in an illustrated format, complete with problem statements received from interviews with disabled people, and from data gathered by unobtrusive observation of them using the physical environment. Awareness of the difficulties facing handicapped people should promote an appreciation of the need for accessibility requirements. It will also allow intelligent decisions to be made in situations where the standard cannot be followed exactly as specified, as is sometimes the case when making existing buildings accessible. In this manner, full accessibility and usability can be achieved, and those with physical, mental and communicative impairments may pursue their interests and aspirations, develop their talents and exercise their skills; in fact, live a rich, full life.

**Michael A. Jones** ARIBA.

Research Architect for the Handicapped



## ACKNOWLEDGEMENTS

The Capital Development Board would like to express its gratitude to all persons who have been involved with the development of these Standards, especially the Advisory Panelists who have given many hours of their own time in working with the Research Architect for the Handicapped.

The Rehabilitation Institute of Chicago, under Hunt Hamill, President and Dr. Henry Betts, Executive Vice-President and Medical Director, deserves particular thanks for the time, advice and help given unstintingly by staff and patients, past and present, especially John H. Catlin, director of Access Chicago, who proved to be a tower of strength during all phases of the project.

Due credit must be given to Ronald L. Mace, AIA, whose work for the removal of environmental barriers in North Carolina is nationally recognized. His "Illustrated Handbook of the Handicapped Section of the North Carolina State Building Code" has successfully demonstrated the usefulness of this type of format for the promulgation of building standards. His unselfish advice and help is much appreciated.

Many of the standards are based on the results of research recently carried out under Federal grants. The Pedestrian Research Laboratory at the College of Architecture, Georgia Institute of Technology has analyzed the needs of elderly and handicapped pedestrians and developed proposals to counteract the problems experienced by these people. This work was carried out for the Federal Highway Administration, Department of Transportation (Contract Number DOT-FH-11-8504) by John Templer, Ph.D., Principal Investigator. The current ANSI A117.1—1961 (R1971) "Specifications for making buildings and facilities accessible to, and usable by, the physically handicapped" is under revision at the Research Office, School of Architecture, Syracuse University with Edward Steinfield, Arch.D., as Project Director. This work was sponsored by the United States Department of Housing and Urban Development, Office of Policy Development and Research (Contract Number H2200). The influence of these projects can be seen in the Accessibility Standards.

## PHOTOGRAPHIC CREDITS

Except where noted on the captions, all photographs are credited jointly to the Illinois Capital Development Board and the Rehabilitation Institute of Chicago. Photographer Scott Schlessler. Sincere appreciation is extended to all agencies, companies and individuals for the use of their photographic material.

Thanks are also due to Larmco Masonry, Inc., of Chicago, for supplying building materials for the layout of test situations; the Chicago Fire Department, North Orleans Station, Snorkel Squad Number 1, for the use of their "Cherry-Picker" for the overhead photographic sequences illustrating maneuvering in a wheelchair; and last, but not least, the Department of Safety Research and Development, General Motors, Detroit, for the loan of their crash dummy which was used to photograph the wheelchair accident sequence.

The generosity and cooperation of all these was invaluable in the creation of the "Accessibility Standards—Illustrated".

Kathy Sisson drew the foot illustrations.  
Ed Dyson was responsible for the rest of the illustrations.  
Michael A. Jones was responsible for the architectural drawings.



# CONTENTS

## INTRODUCTION

## FOREWORD

## PHOTOGRAPHIC CREDITS

## ACKNOWLEDGEMENTS

## GENERAL INFORMATION

1

Scope	1.1.1
Purpose	1.1.2
Definitions	1.1.3
Plans and Specifications to Meet Standards	1.1.4
Enforcement Violations	1.1.5
Revisions to Standards	1.1.6
Severability Clause	1.1.7

## HUMAN DATA

2

Human Data	2.1
Walking Disabilities	2.2
Wheelchair Users	2.3
Dimensions of Wheelchairs	2.3.1
Space Requirements for Maneuvering Wheelchairs	2.3.2
Reaching from a Wheelchair	2.3.3
Space Requirements for Passing	2.3.4
Chronic Impairments of Upper Extremities and Shoulders	2.4
Extremes of Size and/or Maturity	2.5
Chronic Restrictive Conditions Affecting Agility, Stamina and Reaction Time	2.6
Severe Auditory Impairment	2.7
Severe Visual Impairment	2.8
Long Cane Technique	2.8.1
Cue Aids & Alerts	2.8.2
Color Blindness	2.8.3
Obvious Confusion and/or Disorientation	2.9
Difficulty Bending, Turning, Sitting, Kneeling & Rising	2.10
Incontinence	2.11

## SITE DEVELOPMENT

<b>3</b>	<b>Exterior Circulation Routes</b>	<b>3.1</b>
	Walks, Sidewalks	3.2
	Curb Ramps	3.3
	Street Crossings	3.4
	Parking	3.5
	Pedestrian Gates and Turnstiles	3.6
	Site Furniture	3.7
	Locatable Barriers	3.8
	Controls, Dispensers and Receptacles	3.9
	Selection of Building Products and Materials	3.10
	Exterior Stairs and Ramps	3.11
	Exterior Telephones	3.12
	Landscaping	3.13

## BUILDING ELEMENTS

<b>4</b>	<b>Entrances and Doorways</b>	<b>4.1</b>
	Door Handles	4.2
	Door Signs	4.3
<b>5</b>	<b>Interior Circulation</b>	<b>5.1</b>
<b>6</b>	<b>Ramps</b>	<b>6.1</b>
	Stairs	6.2
	Handrails and Guardrails	6.3
<b>7</b>	<b>Elevators</b>	<b>7.1</b>
<b>8</b>	<b>Public Toilets</b>	<b>8.1</b>
<b>9</b>	<b>Drinking Fountains</b>	<b>9.1</b>
<b>10</b>	<b>Shower Rooms</b>	<b>10.1</b>
<b>11</b>	<b>Public Telephones</b>	<b>11.1</b>
<b>12</b>	<b>Communication and Identification</b>	<b>12.</b>
	Signage	12.1
	Emergency Warning Signals and Alarms	12.2
	Tactile Warning Signals and Blind Location Cues	12.3
<b>13</b>	<b>Ground and Floor Surfaces</b>	<b>13.1</b>

<b>BUILDING PRODUCTS</b>	<b>14</b>	Location of Controls, Dispensers and Receptacles	14.1
		Supports	14.2
		Electrical Fixtures and Controls	14.3
		Plumbing Fixtures	14.4
<b>15</b>		Appliances for Public Use	15.1
<b>16</b>		Residential Structures	16.1
		Hotels, Motels	16.2
		Educational Buildings, Libraries and Museums	16.3
		Health Facilities	16.4
		Transportation Terminals	16.5
		Recreational Facilities	16.6
		Auditoria, Arenas, Assembly Halls, and Stadia	16.7
		Service Counters	16.8
		Dining Halls—Restaurants	16.9
<b>17</b>		Remodeling	17.1
<b>18</b>		Historic Preservation and Historic Reconstruction	18.1
<b>REMODELING</b>			
<b>HISTORIC PRESERVATION</b>			
<b>ADVISORY PANELS</b>			
<b>THE LAW AND THE HANDICAPPED</b>			
<b>SELECTED BIBLIOGRAPHY</b>			
<b>INDEX</b>			

## 1.1

### GENERAL

## 1.1.1

### SCOPE

- a. The scope of this Standard is to make the built environment safe and functional for people, including persons with mobility and communicative disabilities.
- b. This Standard applies to all public buildings and site facilities of a permanent or temporary nature, open to and useable by the public, including new construction, remodeling, rehabilitation and historic preservation.
- c. This Standard is concerned with people considered handicapped as a result of physical, mental and communicative disabilities.

## 1.1.2

### PURPOSE

The purpose of this Standard is to provide insight and education to all those responsible for the built environment by providing design requirements which will result in buildings and facilities being safe and functional for people considered handicapped.

## 1.1.3

### DEFINITIONS

**ACCESSIBILITY** is the combination of various elements of the built environment which allows entrance to, egress from, and use of buildings and facilities by the public.

**ACCESS AISLE** is a circulation space between objects such as desks, tables, shelves, displays or cars.

**ADMINISTRATIVE AUTHORITY** is the building department or other regulatory agency having jurisdiction over the issuance of building or occupancy permits.

**AMBULATORY** describes people who walk without assistance or difficulty.

**APARTMENT** means dwelling unit defined by this Standard.

**APARTMENT BUILDING** is any building, or portion thereof, which is designed, built, rented, leased, let or hired out to be occupied, or which is occupied as the home or dwelling unit of three or more families living independently of each other in apartments of the said building.

**AUDIBLE CUE** is a sound or verbal communication or alert.

**BASIC ACCESSIBILITY** is the minimum combination of elements in the built environment which allows entrance and essential use of buildings and facilities by the public.

**BLEND TO A COMMON LEVEL** refers to the meeting of two or more surfaces so that there is no abrupt vertical change in any of the surfaces which could create a tripping hazard or divert the direction of the caster wheels on a wheelchair.

**CIRCULATION ROUTE, PATH OF TRAVEL, PATH** is a way taken by people from one place to another in the environment and includes both horizontal and vertical travel.

**COMPLY WITH, CONFORM TO** means meeting all the requirements of a specific standard or section thereof.

**CUE, CUEING AID** is a device which prepares, alerts or warns people.

**CURB** is the boundary of a street, sidewalk or walk which has been raised to protect or contain.

**CURB RAMP** is a pedestrian ramp which cuts through a curb or builds up to it from a lower level to connect two horizontal levels.

**CROSSWALK, PEDESTRIAN CROSSING** is a marked path designed for pedestrian use in crossing streets.



**DETECTABLE** is that which can be located and identified.

**DISABLING CONDITION** is a permanent or temporary impairment that affects the physique, the mind or communication.

**DWELLING UNIT** is a single unit providing complete independent living facilities for one or more persons, including provisions for living, sleeping, eating, cooking and sanitation.

**ELDERLY** is the population 65 years old and over.

**EXIT** is a continuous and unobstructed means of egress to a public way and shall include, but not be limited to, intervening doors, doorways, corridors, exterior balconies, ramps, stairways, smokeproof enclosures, horizontal exits, exit passageways, exit courts and yards.

**EVACUATION PLAN** is a plan that has been approved and tested by the administrative authority having jurisdiction over the building for the exiting of people from a building or facility in the case of an emergency, and shall have specifically named persons who will aid all disabled people requiring assistance until they are clear of the building. This may involve the use of a key operated elevator for those who cannot use stairs.

**FIRE RESISTIVE RATING** is the time in hours or fractions thereof that materials or their assemblies will resist fire exposure, as determined by fire tests conducted in compliance with recognized standards.

**FULL ACCESSIBILITY** is the combination of various elements of the built environment which allows entrance to, and maximum use of buildings and facilities by the public.

**HANDICAPPED PERSON** means a person who, on account of a physical, mental or communicative disability, is restricted in the use of the built environment because of obstacles which the lack of suitable facilities interposes between the individual and his or her maximum functional level.

**Note:** Characteristics of the built environment, rather than the degree of disability, determine whether or not a person is handicapped. A handicap occurs when a person encounters an environmental barrier which prevents or inhibits activities of daily living. For example, narrow toilet doors, not affording access to a person in a wheelchair, will prevent the employment of that person in a building; or a child, considered able-bodied, is handicapped when stranded in a malfunctioning elevator of a high-rise apartment building because the emergency button and telephone are out of reach.

**HARD SURFACE** is a prepared surface which is firm and stable, even when wet.

**HISTORIC PRESERVATION AND HISTORIC RECONSTRUCTION** embraces all buildings, facilities, open spaces, and historic districts which are built, repaired and/or have changes in the occupancy, will be open to the public, and appear on the national or state Historic Register, or nominated for either. Historic preservation and historic reconstruction shall conform to this standard and provide basic accessibility. See Section 18 for specific requirements.

**IN-CAR LANTERNS** are visual signals located on elevator car door jams indicating the direction of travel.

**INCOORDINATION** is the inability to produce desired harmonious muscular action.

**INCONTINENCE** is the inability to control bodily evacuative functions.

**INTERIOR OFFICE LANDSCAPING** is office space defined with non-structural, relocatable partitions.

**ISLAND** is a place of refuge for pedestrians in the middle of a street.

**LIP** is an abrupt vertical change in level.

**LISTENING SYSTEM** is a built-in audio system provided for auditory impaired persons.

**MAJOR ENTRANCE** is any access point to a building, portion of a building or facility used for the purpose of entering, but does not include doors to fire stairways, other emergency exits, or doors used for servicing the building.

**MANUAL DOOR OPENER** is a non power-operated device that is used for opening doors.

**MEANS OF EGRESS** is the path of exit travel from any point in a building or facility that meets all applicable code requirements of administrative authorities with jurisdiction over the building or facility.

**NON-DETECTABLE AREA** is the area that cannot be located by long cane techniques used by the blind and visually impaired.

**OCCUPANCY** is the purpose for which a building or part of a building is used or is intended to be used.

**OPERABLE PART** is that part of a device or mechanism that is used to activate, control or adjust equipment, apparatus and appliances.

**ORTHOTIC** is a bracing device used to strengthen or assist a part of the body.

**PASSENGER LOADING ZONE** is a place specially provided outside of the vehicular traffic flow designed for the drop-off or pick-up of passengers from vehicles.

**PAY TELEPHONE** is a public or semi-public, coin-operated telephone.

**PERCEIVABLE** is that which can be detected by one of the senses, with or without an aid.

**PREVAILING EQUIVALENT SOUND LEVEL** is the normal, average sound level to be expected in a given environment, excluding sounds of short-term duration such as fire, police or ambulance sirens, passing train noises, whistles, horns and telephone bells, etc.

**PROSTHESIS** is an artificial device to replace a missing part of the body.

**PUBLIC BUILDING MEANS:**

- a. A building, structure or improved area owned or leased by this State or its political subdivisions;
- b. A building, structure or improved area used primarily as a place of gathering or amusement;
- c. Office buildings and factories. The second floor of any two-story office building or factory having less than 15,000 square feet at the second floor level, or any occupied levels below grade having less than 15,000 square feet (unless the building is publicly owned) are not required to be wheelchair accessible.

All publicly and privately owned buildings will comply with this Standard except single and two family residences and the second and third stories of apartment buildings not served by elevators.

**Note:** The application of this Standard includes, but is not limited to, the following building types:

**Sleeping Occupancy:** Apartment buildings, apartments, hotels, motels, hostels, dormitories, housing for the elderly, housing for the handicapped, etc.

**Business Occupancy:** Offices, shops, department stores, grocery stores, fast food establishments, etc.

**Educational Occupancy:** Day care centers, primary, secondary and post secondary educational facilities of a public or private nature, museums, art galleries and other cultural facilities, etc.

**Industrial Occupancy:** Factories, warehouses, plants, industrial parks, etc.

**Assembly Occupancy:** Stadia, auditoria, theaters, dance halls, skating rinks, bowling alleys, restaurants, taverns, night clubs, cafeterias, banquet halls, etc.

**Institutional Occupancy:** Hospitals, nursing homes, mental institutions, jails, prisons, etc.

**Outdoor Areas:** Parks, camping grounds, public swimming pools and beaches, zoos, botanical gardens, amusement parks, fairgrounds, playgrounds, etc.

**Transportation Facilities:** Bus, train, air terminals and/or stations.

**Places of Worship and Meditation:** Churches, Synagogues, Temples, etc., including ancillary educational facilities.

**Other:** Funeral homes, fraternal and private organization facilities including country clubs, parking garages, gas stations, etc.

**PUBLIC SPACES** are those spaces in a building or facility that are available for use by all people in that environment.

**PUBLIC** means users of buildings and facilities, including handicapped persons. Users fall into two categories, visitors and employees, and the functional needs of handicapped persons as visitors and employees shall be considered in new construction and remodeling of buildings and facilities.

**REDUNDANT CUE** is a method of communicating a message, instruction or warning in a multiple way, so that it can be perceived by more than one of the senses. For example, a curb ramp having a surface which contrasts in color and texture with the adjacent surfaces can be perceived by blind and sighted people. Flashing lights accompanying alarm bells warn deaf, blind and able-bodied of the danger.

**REFUGE** is a place that provides protection from danger.

**REGULAR BUSINESS HOURS** are those hours in which a building is kept open to the public for the regular transaction of business, recreation, etc.

**REMODELING** embraces rehabilitation and renovation of existing buildings including improvements, extensions, repairs, structural alteration, changes in design or layout, or changes in the occupancy of the building. Maintenance, redecoration, changes to the heating, ventilation and air conditioning systems or reroofing, and changes to interior office landscaping shall not be included under remodeling requirements. See Section 17 for specific requirements.

**SEMI-AMBULATORY** describes those people who walk with difficulty, with or without aids, such as canes, crutches or walkers.

**SERVICE ENTRANCE** is an entrance intended for the servicing of a building or facility and used by maintenance and service personnel, and others delivering or removing goods and/or chattels.

**SIDEWALK** is a prepared walk within a street right-of-way.

**SINGLE FAMILY RESIDENCE** is a building that contains one dwelling unit.

**SITE** is a parcel of land bounded by property lines.

**SITE ACCESS POINT** is the place where the property line or boundary is crossed in order to gain access to the site, or buildings and facilities on the site.

**SITE FURNITURE, STREET FURNITURE** is permanent equipment located on the site outside of buildings and facilities including benches, tables, lighting poles, telephones, drinking fountains, signs and other devices of a functional or decorative nature.

**SPASTICITY** is involuntary muscle spasms which cause parts of the body to move or jump.

**SUITABLE FACILITIES** means environments and their components which are safe, convenient and functional, and accommodate the abilities of the maximum number of people; for example, door hardware which does not require grasping and twisting of the wrist to open the door can be operated by more people than a device which requires the grasping and twisting movements.

**SUPPORT** is a device that is provided in the environment to assist people while they are changing position or walking and include, but not limited to, grab bars, handrails, guardrails, poles and shower seats.

**TACTILE CUE** is an alert warning device that can be perceived by using the sense of touch.

**TWO FAMILY RESIDENCE** is a building containing two dwelling units.

**VISUAL AID** is a visible cueing device used to prepare, alert or warn.

**VISUAL EMERGENCY WARNING** is a flashing light that is used to arouse and alert the deaf and hard of hearing of an emergency.

**WALK** is an exterior pathway with a prepared surface intended for pedestrian use.

**WALKING AID** is a device to aid walking such as a cane, crutch or walker.

**ZONED ELEVATOR** is an elevator which does not stop at all floors but serves specific floors in a building.

**1.1.4**

**PLANS AND SPECIFICATIONS TO MEET STANDARDS**

One year after the approval of these Standards, the appropriate contracting authority must determine that the plans and specifications of every public building which the State or any political subdivision, governmental entity or public authority constructs or remodels shall meet these Standards.

One year after the effective date of these Standards, no building permit or other official authorization for construction of a public building as defined in Section 1.1.3 is valid, unless it recites that the plans and specifications meet these Standards.

**1.1.5**

**ENFORCEMENT VIOLATIONS**

The Attorney General shall investigate any complaint or reported violation of these Standards, and where necessary to ensure compliance with these Standards, the Attorney General may, at any time, bring action for mandamus, injunction or other appropriate relief.

**1.1.6**

**REVISIONS TO STANDARDS**

These Standards may be revised from time to time by the Capital Development Board. Revised standards shall be published as tentative versions. Public hearings shall be held within three months of publication of the tentative standards, if requested in writing by any interested person. Within six months after the publication of tentative standards, the Capital Development Board shall issue final standards. Tentative and final standards shall be filed with the Secretary of State in accordance with 'An Act Concerning Administrative Rules' Illinois Revised Statutes Chapter 127, Section 1, et seq.

**1.1.7**

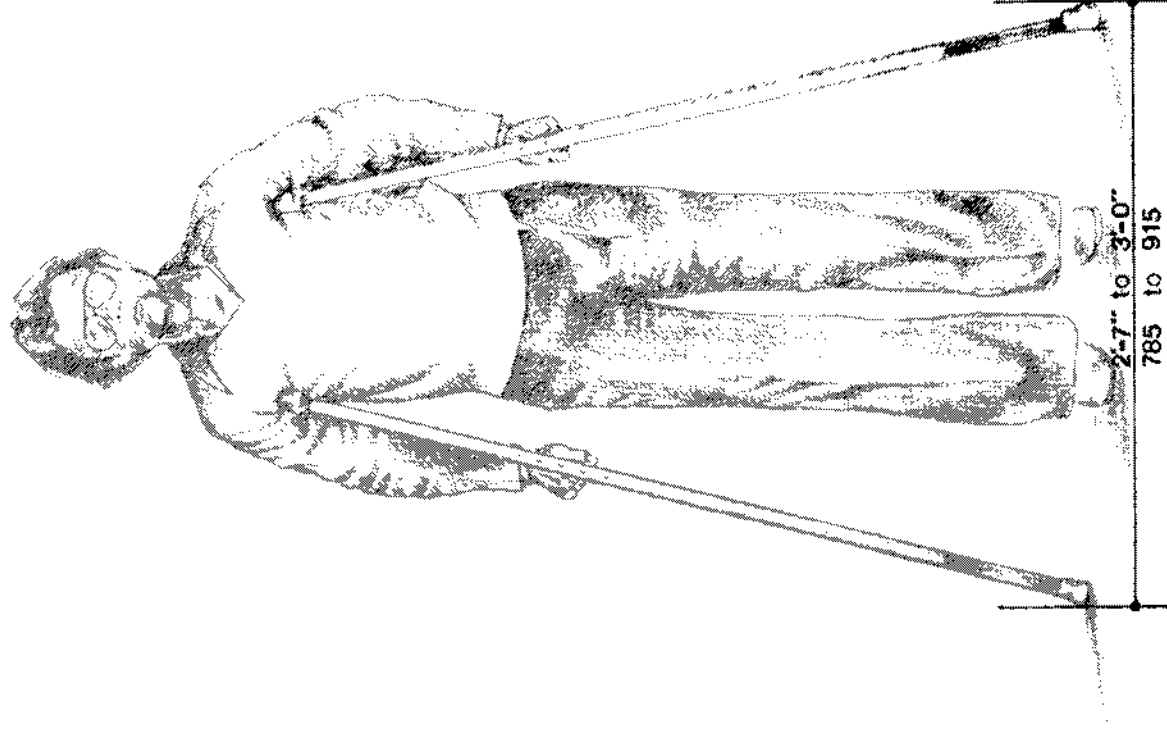
**SEVERABILITY CLAUSE**

If any provision of these Standards or application thereof to any person or circumstances is held invalid, such invalidity does not affect other provisions or applications of these Standards, which can be given effect without the invalid provision or application. To this end, the provisions of these Standards are declared to be severable.

## HUMAN DATA

In order to produce a safe and accessible environment, a comprehensive understanding of the characteristics of human performance is needed so that design decisions can be made with full knowledge of the consequences of the effects of these decisions upon the users of the environment. By promoting an understanding of the problems encountered by disabled people, items not specifically named by the Standards shall also be made accessible. Categories of disability have been prepared to assist those involved with the design of buildings and related facilities in understanding the basic needs of persons in each category. All people require assistance at one time or another because of accident, illness or the physical constraints accompanying the normal life cycle. The list is by no means mutually exclusive, and a person may suffer from more than one disabling condition. The categories of disability are:

Walking Disabilities	Section 2. 2
Wheelchair Users	Section 2. 3
Chronic Impairment of the Upper Limbs and Shoulders	Section 2. 4
Extremes of Size and Maturity	Section 2. 5
Chronic Restrictive Conditions	Section 2. 6
Severe Auditory Impairment	Section 2. 7
Severe Visual Impairment	Section 2. 8
Obvious Confusion and/or Disorientation	Section 2. 9
Difficulty Bending, Sitting, Kneeling and Rising	Section 2.10
Incontinence	Section 2.11

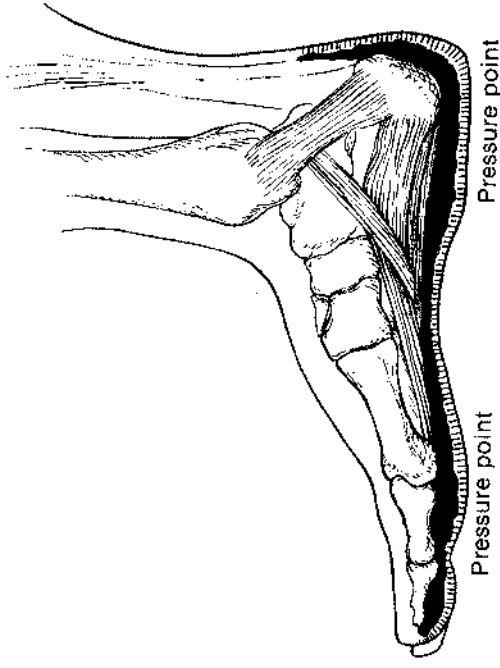


## WALKING DISABILITIES

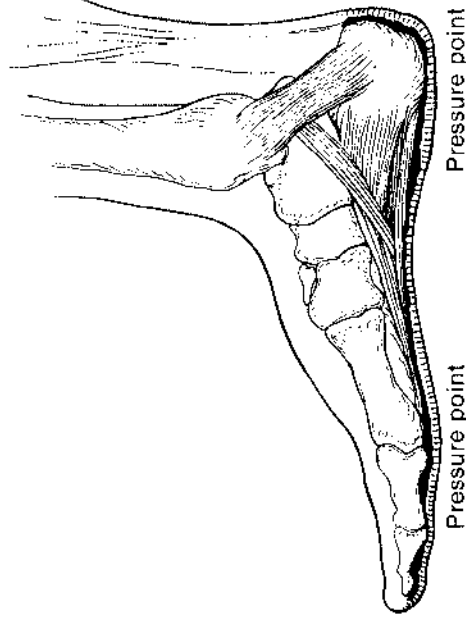
There are two main groups of people in this category. The first group includes those who walk with difficulty without the use of a special aid, such as people who limp, shuffle, or have difficulty with balance. The other group includes people who walk with difficulty with the use of prosthetics, such as artificial legs, or who use orthotics, such as braces of any kind, crutches, canes, walking sticks, special shoes, walkers, etc.

Persons with walking disabilities can experience a range of difficulties when using the physical environment. These people may have reduced balance, agility, or speed of movement, or a combination of all three which contribute to their problems of mobility. The walking surface is critical to safe passage. Unevenness, raised joints, or debris can be hazardous. This is particularly true of very small changes, such as a vertical  $\frac{1}{4}$ " joint between two surfaces, or a tiny pebble on the surface, both of which are difficult to perceive. This can result in a trip or sudden loss of balance, causing a person to fall. Semi-ambulatory persons using crutches require a minimum width of 3'-0" on walkways to accommodate the spread of crutches.

While aiding mobility generally, a prosthesis may add to a semi-ambulatory person's predicament in certain situations, such as climbing or descending stairs, or opening and passing through heavy doors. Thus handrails are required when level changes occur, and exterior doors requiring an excess of 15 lbf. to open shall have automatic assists.

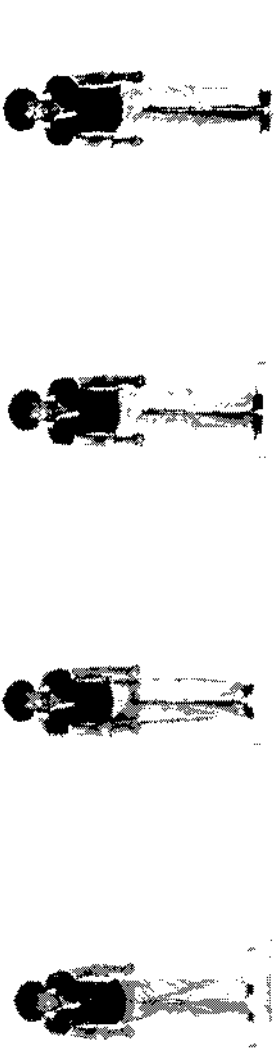


**Figure 2.2 A-1**  
Foot of average person. Note the fairly thick layer of cushioning tissue along the sole of the foot.



**Figure 2.2 A-2**  
Foot of elderly person showing the natural degeneration of tissue. The removal of this cushioning tissue may result in pain when standing. Consequently this is one reason why some people walk slowly or shuffle.

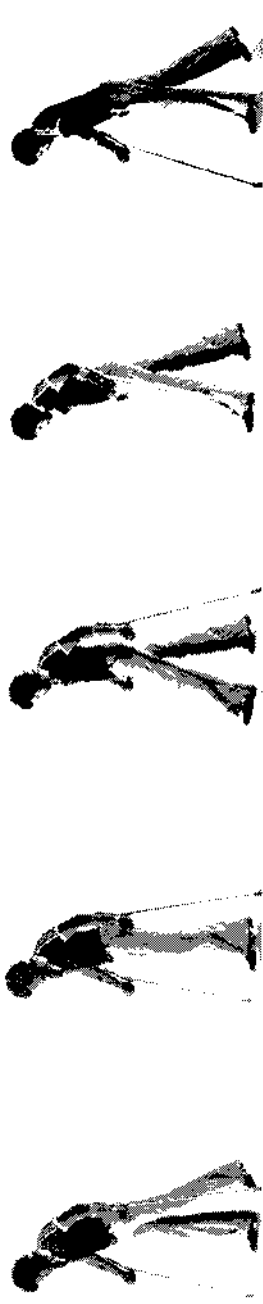
The swing through method of walking with crutches places all the weight of the body on the crutch tips. Thus the choice of the surface material is critical.



Irregularities in the surface may handicap the person on 'take-off' and 'landing'.



The walk through method using crutches.



An 'able-bodied' person lifts his feet clear of the ground, yet trips may still occur.



An elderly person who shuffles barely lifts his feet off the ground, and any imperfection in the walkway surface may be hazardous.





**WHEELCHAIR USERS**

This category includes wheelchair users of all ages, with upper and lower limb involvement, and lower limb involvement, and who use manually or electrically operated wheelchairs.

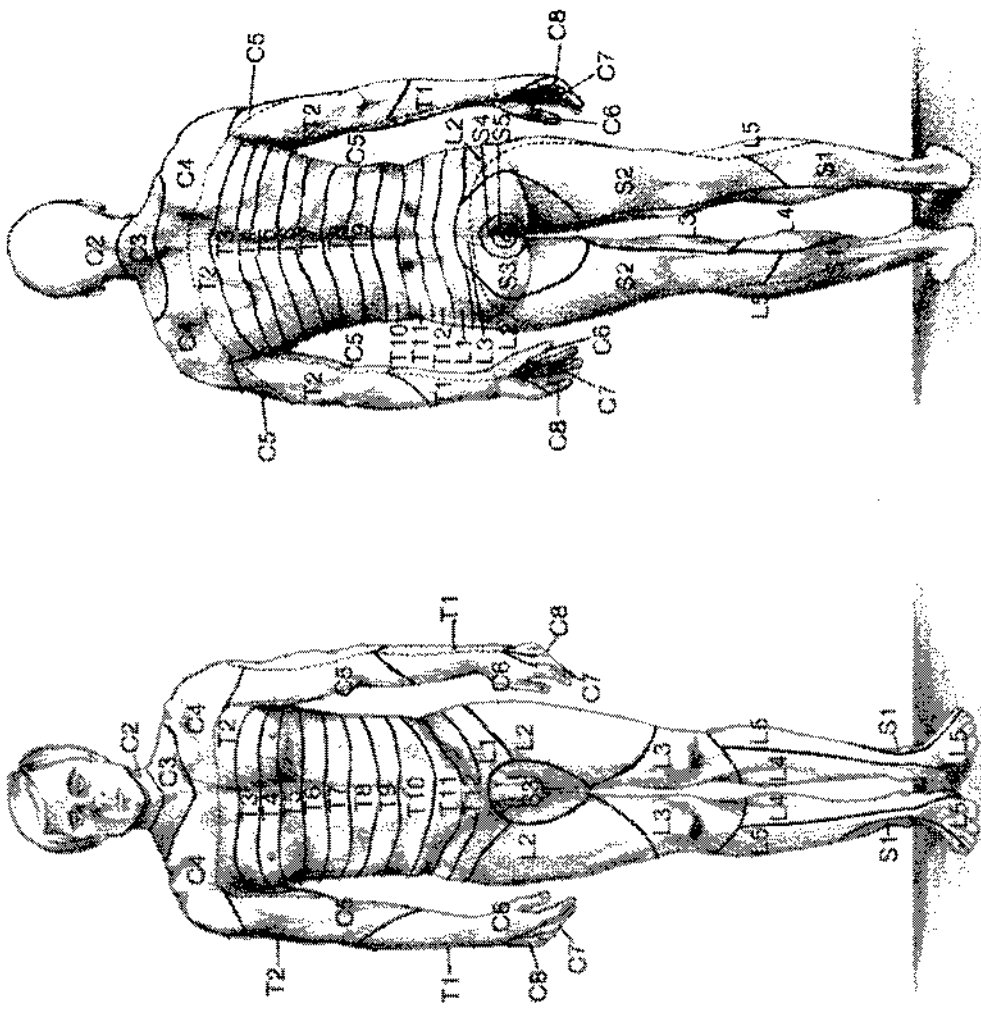
The physiological capabilities of persons who use wheelchairs are as varied as the physiological capabilities of the ambulant population. Illness related disability, congenital defects and accidents affect all parts of the body, leaving limbs in various stages of weakness, paralysis or absence. Without the ability to adequately control the affected muscles, the user is constantly beset with the problem of keeping his trunk balanced in the chair. In unfamiliar environments, where hazards are unknown, the fear of falling out of the chair is particularly oppressive. Reaching is always a problem, and one arm is generally used as a counter-balance, gripping the handle, armrest or drive rim while the other performs its task. Activities that require hand and arm interaction and the use of both hands, such as using the telephone, often create a sense of frustration and dissatisfaction with the environment, particularly when lack of trunk balance results in the inability to perform the task.

Paralysis of the limbs reduces muscle tone and blood circulation, and as the pelvis presses down and prevents the blood flow to the skin tissues, pressure sores may develop, either internally or externally. Large sores require surgery or months of convalescence. Reduced muscle tone may also result in blood pooling in the feet and legs. Accessible environments encourage mobility for those in wheelchairs, and the exercise automatically gained goes a long way in preventing the medical problems of pressure sores and blood pooling.

Paralysis not only affects motor control, but may also result in that portion of the body which is paralyzed being insensitive to external stimuli, such as touch, temperature or even awareness of the position of the affected limb. Wheelchair users can be burned by hot water pipes below lavatories, or injured on sharp edges or abrasive surfaces and be completely unaware of the injury until disrobing later in the day.

People's renal and urinary excretory systems are designed to function optimally when they are in the vertical position, that is, when they are standing and walking. The effects of immobility result in, among other things, atrophy, protein breakdown, decalcification and changes in composition and volume of urine. Kidneys excrete larger than normal amounts of minerals and salts which have been released into the blood as a result of the effects of immobility on other body organs. If the urine is kept diluted, there is less likelihood of the formation of kidney and bladder stones, urinary tract infection and other complications. Renal complications are the leading cause of death in paraplegics and quadriplegics. It is imperative that large amounts of fluid intake be made regularly throughout the day. Drinking fountains and water coolers provide a major source of fluids readily available to the public, and shall be accessible to all people. They are more than a convenience for people who depend on large volumes of fluid intake for their very existence.

The severely disabled with upper and lower limb involvement often use electrically powered chairs. Because of the physical limitations of movement of their extremities, most quadriplegics require wheelchair control devices which are designed for a light touch and minimum movement. This, in turn, creates problems, as uneven surfaces can jolt the hand operating the controls resulting in erratic movement, or sudden stops. Some persons in wheelchairs leading active, productive lives control their wheelchair by breathing into and sucking on a tube connected to electrical devices.

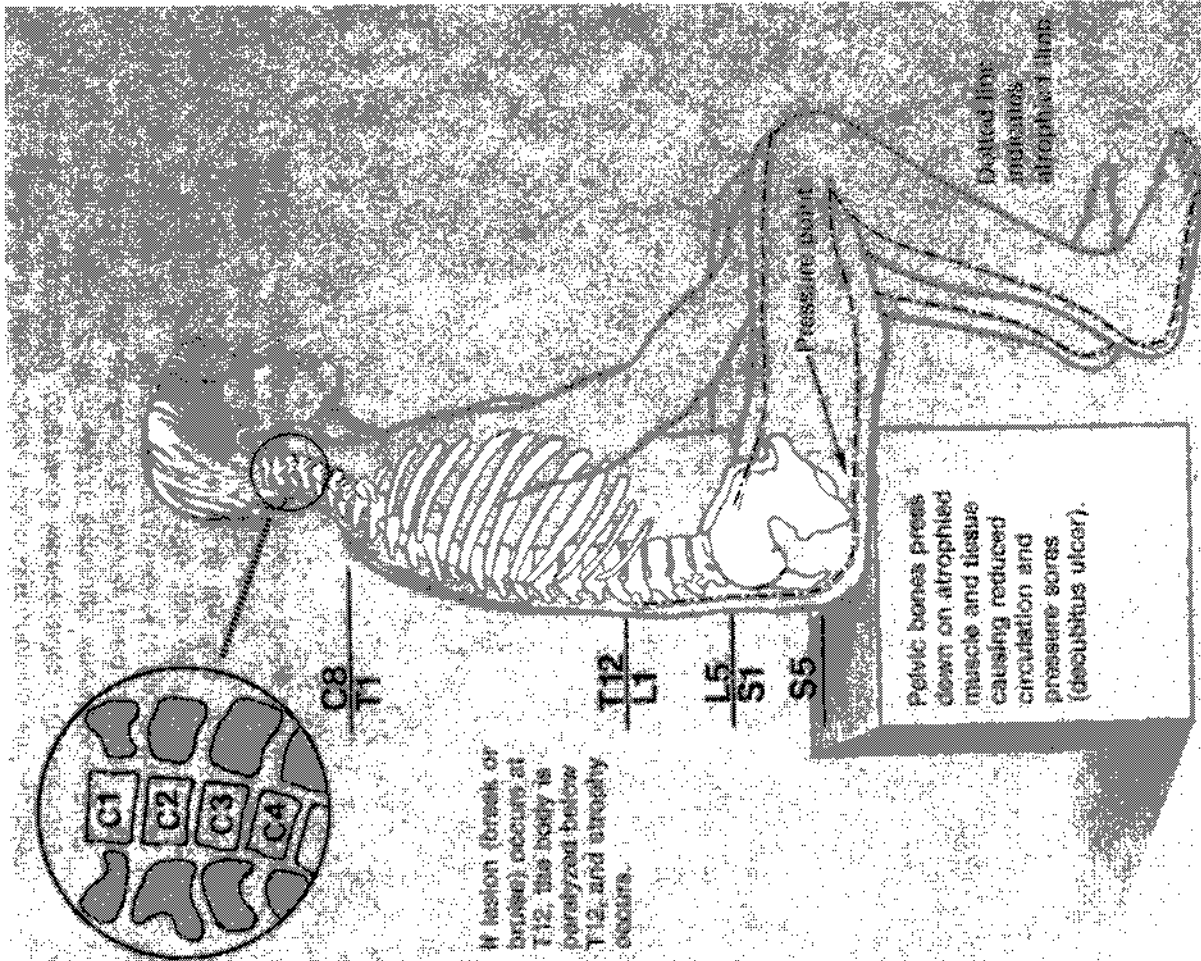


**Figure 2.3** Parts of the body which become paralyzed following a spinal lesion.

Fracture—dislocation of particular spinal cord segments affects various parts of the body. By and large, paralysis occurs below the lesion, though it need not be total. The following gives an indication of the parts of the body affected by a lesion at a particular segment.

- Lesion at C4 affects the diaphragm
- Lesion at C5 affects the biceps, arms
- Lesion at C6 affects the wrist flexion and extension
- Lesion at C7 affects the triceps
- Lesion at C8 affects the hand
- Lesion at T2—T7 affects the chest muscles
- Lesion at T9—T12 affects the abdominal muscles
- Lesion at L1—L5 affects the leg muscles
- Lesion at S2 affects the bowel and bladder

The person with a complete fracture-dislocation at the level of C3 or above usually will not survive.



**Figure 2.3** Diagrammatic illustration showing spinal cord and some of the physical problems which follow a lesion.

### 2.3.1

## DIMENSIONS OF WHEELCHAIRS

The space requirements for wheelchairs, Section 2.3.2, are based upon the physical dimensions of the manual, adult-sized wheelchair. These dimensions will satisfy most electrically operated wheelchairs. Wheelchairs are 1'-6½" to 2'-8" in width, although wheelchairs 2'-0" to 2'2" in width are most commonly used; 3"-6" to 4'-0" in length; 1'-7" from the ground level to top of the seat; 2'-6" from ground level to the top of the armrests; and 3'-0" from ground level to the top of the push handle; See Figure 2.3.1. Specially or individually equipped wheelchairs may exceed these dimensions.



**Pressure sores or decubitus ulcers can affect people who are confined to wheelchairs. They usually occur at the pressure points between the body and the chair.**

Photo: Scott Schlesser

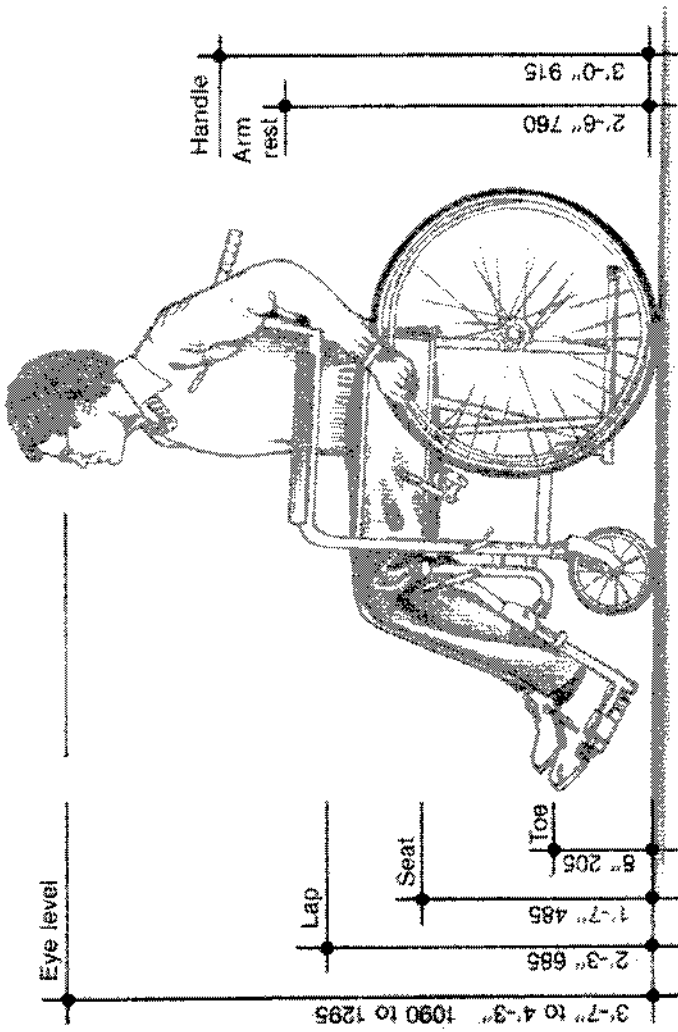


Figure 2.3.1  
Dimensions of a manual, adult sized wheelchair

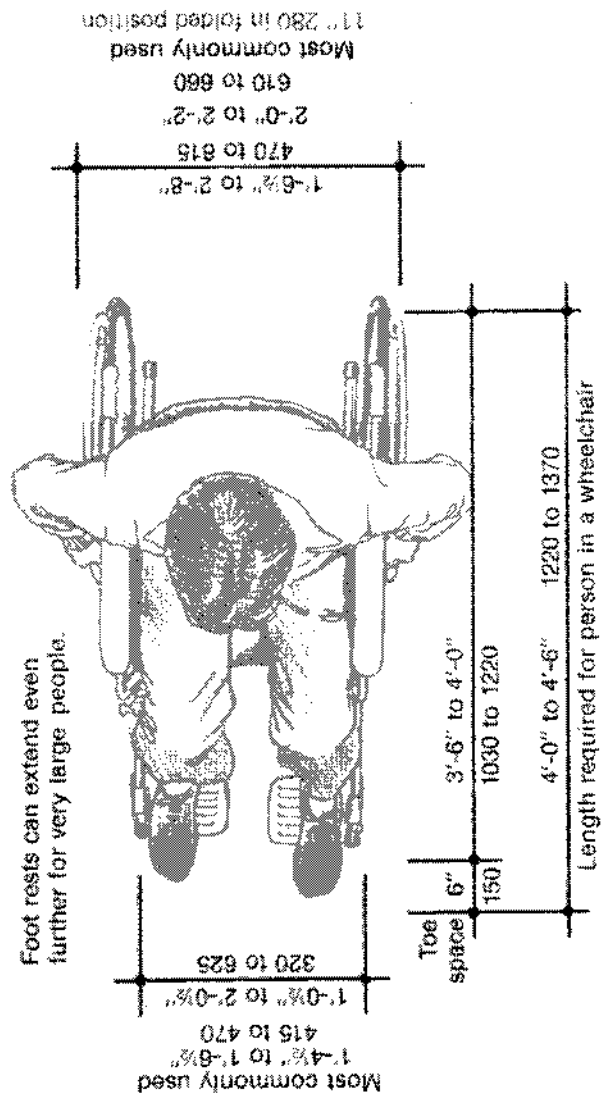
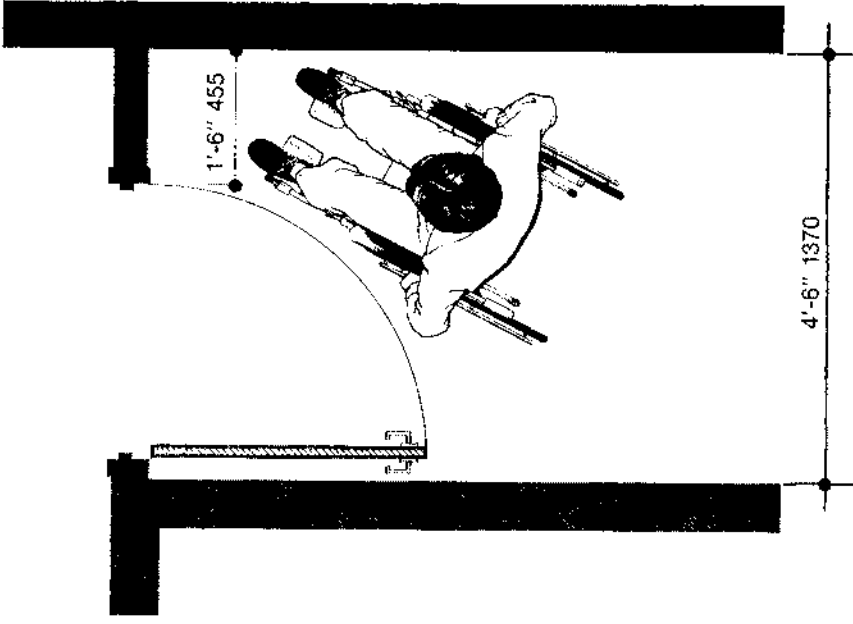


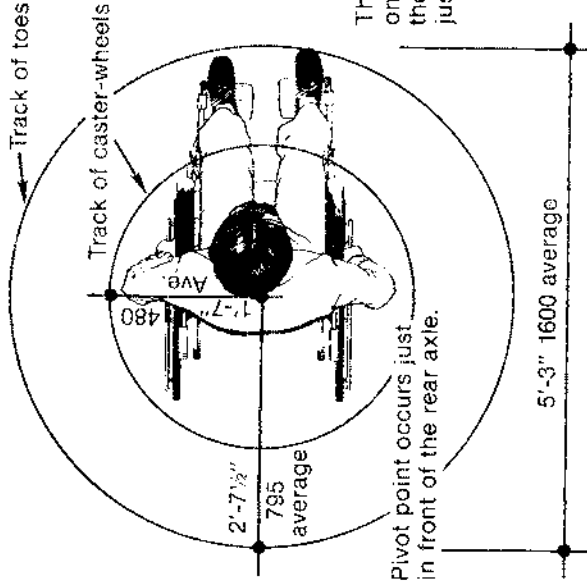
Figure 2.3.1  
Dimensions of wheelchairs

**SPACE REQUIREMENTS FOR MANEUVERING WHEELCHAIRS**

Figures 2.3.2 A, B, C and D illustrate the minimum requirements for the maneuvering of wheelchairs. The minimum width that can be negotiated by most people in a wheelchair is 2'-6". However, this does not allow for any tolerance for the path of travel. An exact line of travel is not always possible because of a variety of factors. The differing strengths of each arm may mean an erratic path of travel; others move their wheelchairs by using their feet on the ground, again resulting in imprecise travel. The location of an opening off a narrow hall may be such that precise approach is not possible, therefore tolerance is required. Although 2'-6" will allow the passage of a standard wheelchair, a 2" tolerance shall be added to allow for imprecise movement and space for the hands on the drive rim. A minimum clear door opening width of 2'-8" is required. The minimum widths for circulation require extra tolerances and shall be as shown in the accompanying diagrams, Fig. 2.3.2 A through Fig. 2.3.2 D.



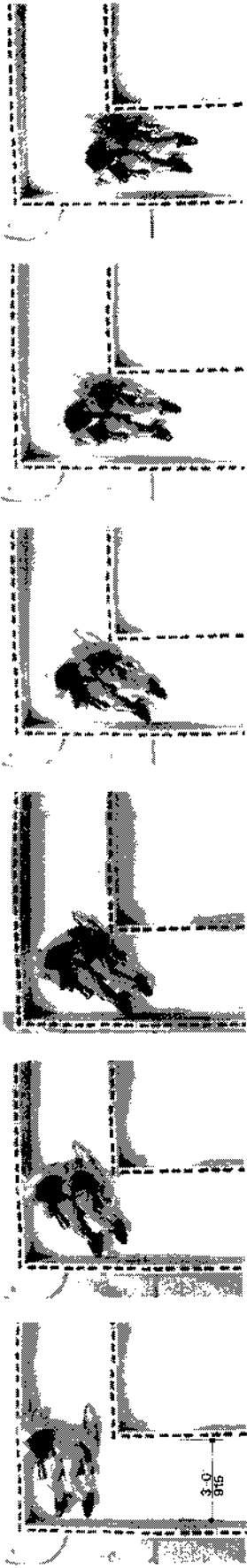
**Figure 2.3.2 D**  
Minimum dimension of corridor width with door opening into the corridor.



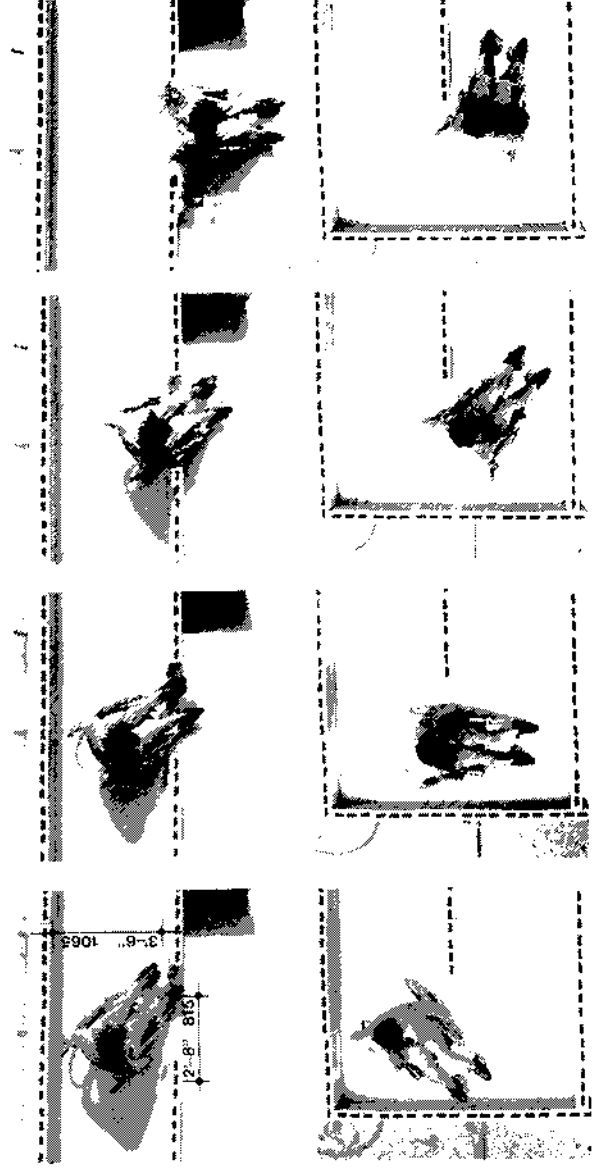
The smallest turning radius is achieved by moving one wheel forward while simultaneously moving the other backward to pivot about a point entered just in front of the rear axle.

**Figure 2.3.2 D-1**  
Turning radii of a wheelchair

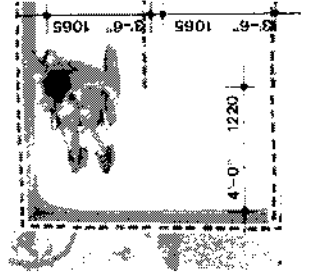
Making an L-turn in a 3'-0" corridor is an extremely tight maneuver.



To make a turn into a 2'-8" clear opening a minimum corridor width of 3'-6" is required.



To make a 180° turn around a wall, corridors shall be 3'-6" minimum in width and the turn space shall be 4'-0" minimum in width.



### 2.3.3

#### REACHING FROM A WHEELCHAIR

Figures 2.3.3 A and B give reach ranges of adult persons in wheelchairs. Many persons may not be able to accomplish all movements, particularly those who are strapped to the chair to prevent falling, because of the lack of trunk balance or because of spasticity. For others, head movement is severely restricted. Thought should be given to the location of devices so that they will occur well within the ranges shown here. Where children are in the majority of the served population, their reach limitations should be considered, see Table 16.3.1.

Due to lack of trunk balance, some individuals are unable to lean forward and thus forward reach is restricted.

- Critical point for forward reach at wall condition.
- ★ Highest operable mechanism of any device that can be reached by forward access only.
- \* Toes hitting a wall prevent maximum forward reach from being achieved.

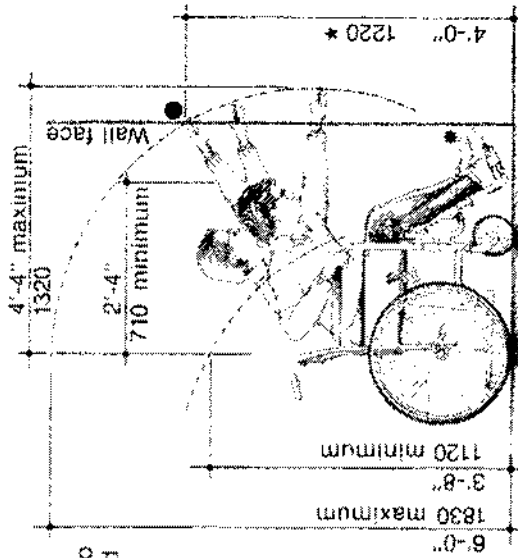


Figure 2.3.3 A

Range of forward reach dimension from a wheelchair.

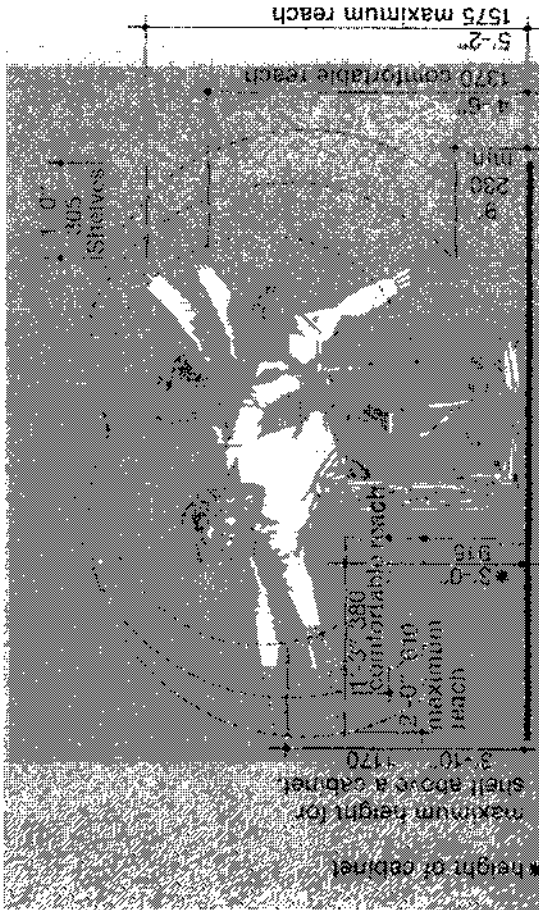
### 2.3.4

#### SPACE REQUIREMENTS FOR PASSING

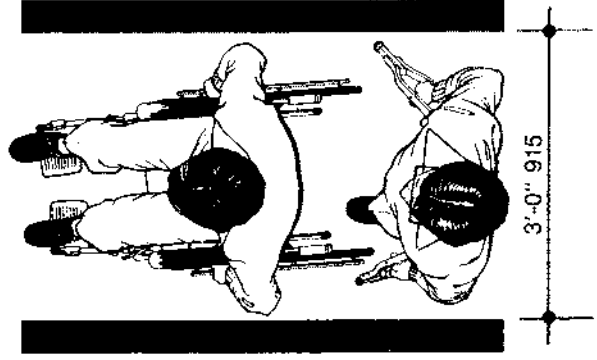
The minimum space for a person walking in single file between two walls in a non-crowded condition is 2'-9". This is made up as follows:

1'-8"	shoulder width
1½"	winter clothing
4"	arm swing
3½"	lateral displacement
2"	wall clearance
2"	for tracking error
<b>2'-9"</b>	<b>total</b>

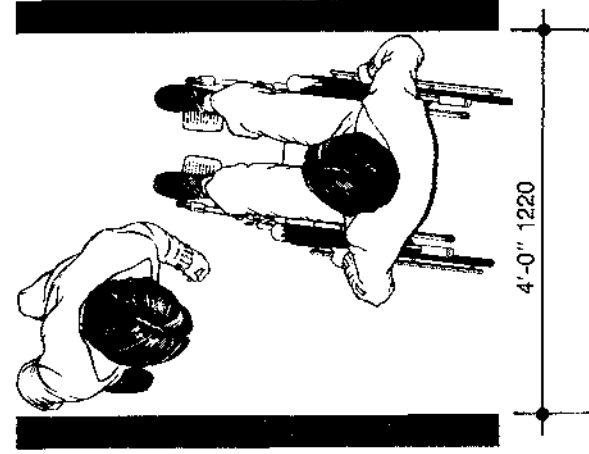
For unrestricted and comfortable flow of ambulatory and wheelchair pedestrians, 5'-4" is required. 5'-0" is the minimum requirement for two wheelchairs to pass. Ambulatory persons can pass a wheelchair in a 4'-0" wide space, but they have to twist their bodies to do so. This does not allow for sway or tracking error, but is generally acceptable.



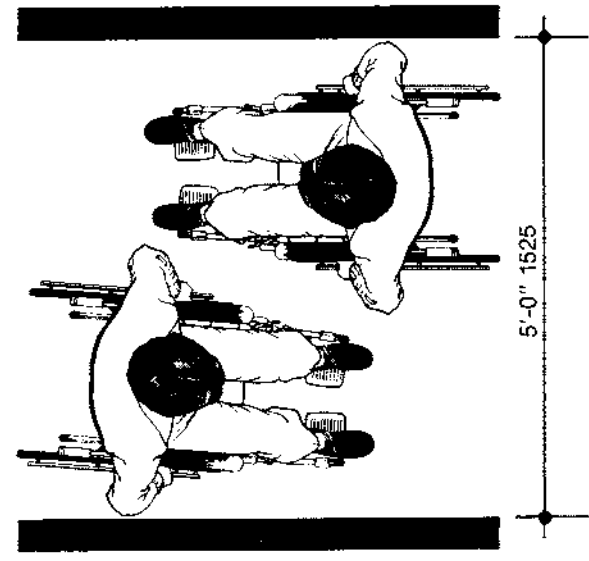
**Figure 2.3.3 B**  
 Range of reach dimensions on each side of a wheelchair. Narrow shelves and cabinet/worktop indicated to illustrate furniture constraints.



**Figure 2.3.4 A**  
 Minimum corridor width. Does not allow passing.



**Figure 2.3.4 B**  
 Minimum corridor width which allows passing of a pedestrian and a person in a wheelchair.



**Figure 2.3.4 C**  
 Minimum corridor width which allows two wheelchairs to pass



## CHRONIC IMPAIRMENT OF UPPER EXTREMITIES AND SHOULDERS

Persons with amputation, effective loss of the use of upper limbs or hands, or who have muscle coordination difficulties fall into this category.

The manipulation skills required to operate hardware devices often include grasping, pinching or twisting, and persons in this category may find it impossible to do any or all of these tasks. Frequently, the force required to operate devices, or the small size of such devices, contribute to making them inoperable by those with upper limb impairments. Incoordination creates many problems for persons trying to operate devices. For example, inserting money into coin slots is extremely difficult with trembling fingers, as is sometimes the case for persons who have cerebral palsy, multiple sclerosis, Parkinson's disease, etc. Several "touch" type elevator buttons can be operated inadvertently in the attempt to activate the one desired. Hand-operated devices or equipment should be chosen so that they are as large as possible and operable without precise finger operation, or the need to twist the wrist, pinch, or grasp.

The loss of use of upper extremities can also affect balance. This problem can increase if the person is carrying a parcel or briefcase. Handrails are needed where changes of level occur to allow individuals to lean against them in order to keep their balance.

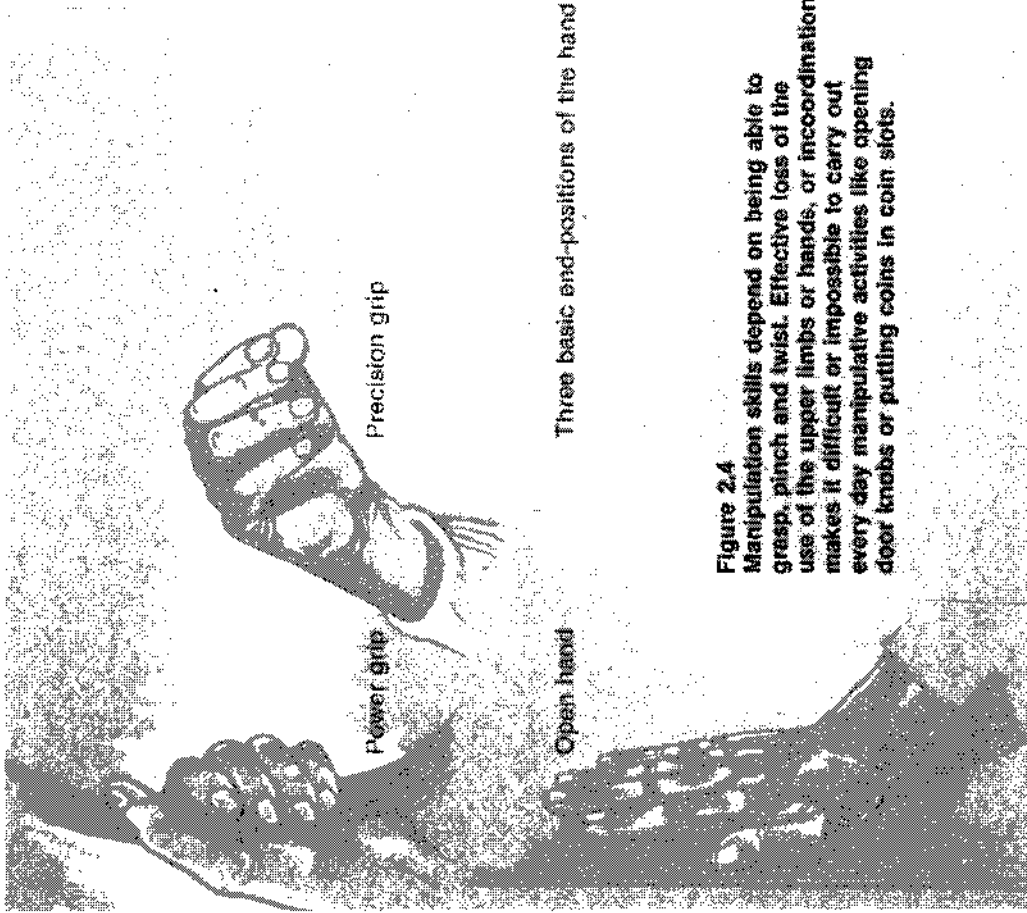
### Upper limb impairment.

Photo: Mayor's Office for Senior Citizens and the Handicapped, Chicago

### Arthritic hand.

Photo: Scott Schlessner





Three basic end-positions of the hand

**Figure 2.4**  
 Manipulation skills depend on being able to grasp, pinch and twist. Effective loss of the use of the upper limbs or hands, or incoordination makes it difficult or impossible to carry out every day manipulative activities like opening door knobs or putting coins in coin slots.

Prosthesis replaces left extremity

Photo: Illinois Department of Vocational Rehabilitation



## EXTREMES OF SIZE AND/OR MATURITY

This category includes persons with dwarfism, gigantism and obesity. Able-bodied children below the age of 17 are also included in this category. In addition to their size limitations, the young may also be handicapped because their mental development is not complete. The lack of maturity results in the occasional confusion in perception of, or indecisive reaction to, the built environment and may place children in vulnerable situations. Children are disproportionately represented in pedestrian accident statistics. In fact, the greatest number of pedestrian accidents involve this group of people.

Women may find that the environment becomes more hazardous during the latter months of pregnancy when their balance is affected, bending is difficult, obstacles in walkways may not be seen, climbing stairs becomes very tiring or hazardous because the center of gravity has been temporarily altered, and, depending on the position and size of the fetus, shortness of breath is common.

The dimensions and reaching limits illustrated in Figures 2.5 A, 2.5 B and 2.5 C are for the 95 percentile male adult, the 2.5 percentile female adult, and the 50 percentile male first grader. Additional tolerance should be made for height dimensions to accommodate clothing and encumbrances that may be carried by people. The adult percentiles shown with respect to reaching and space requirements accommodate most ambulatory people. The 2.5 percentile for women is approximately the same as the 97.5 percentile of a 9-10 year old boy or girl.

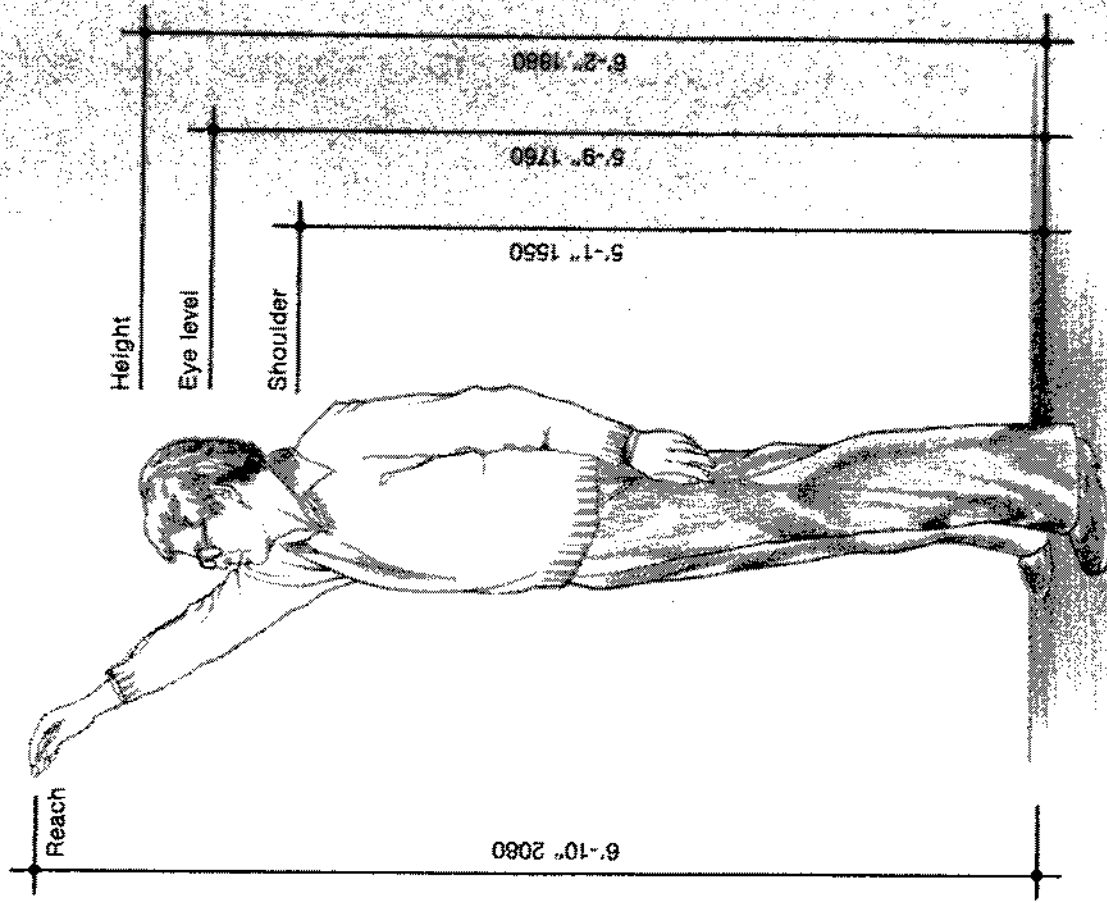


Figure 2.5 A  
Tall male (95 percentile)

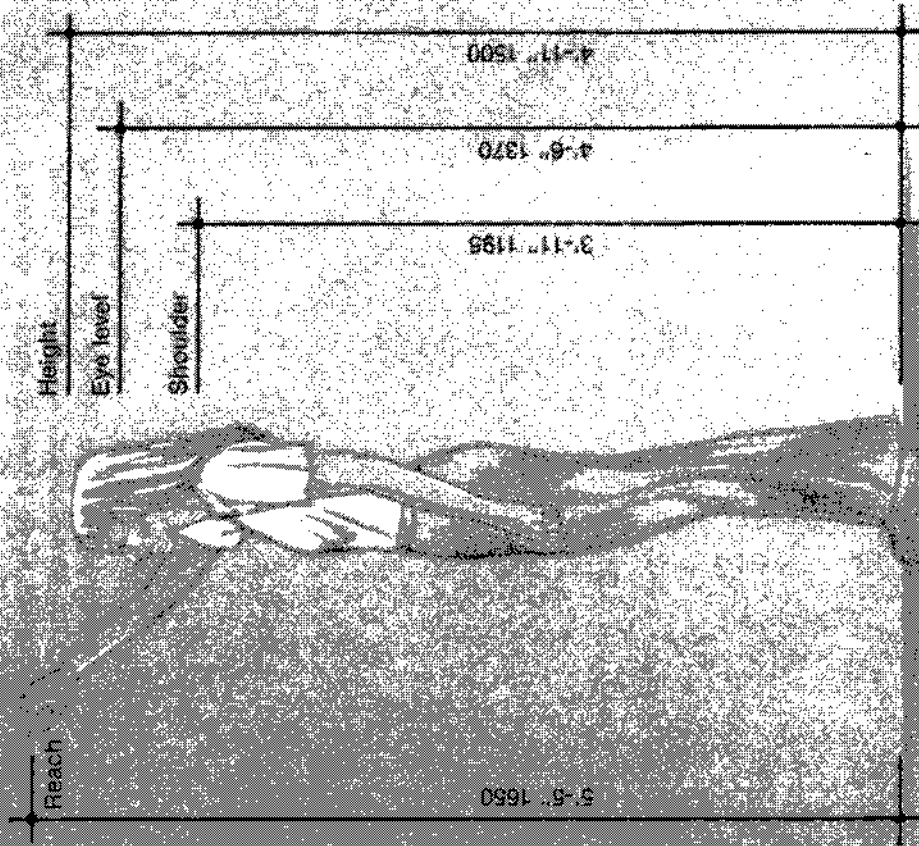


Figure 2.5 B  
Small female (2.5 percentile)

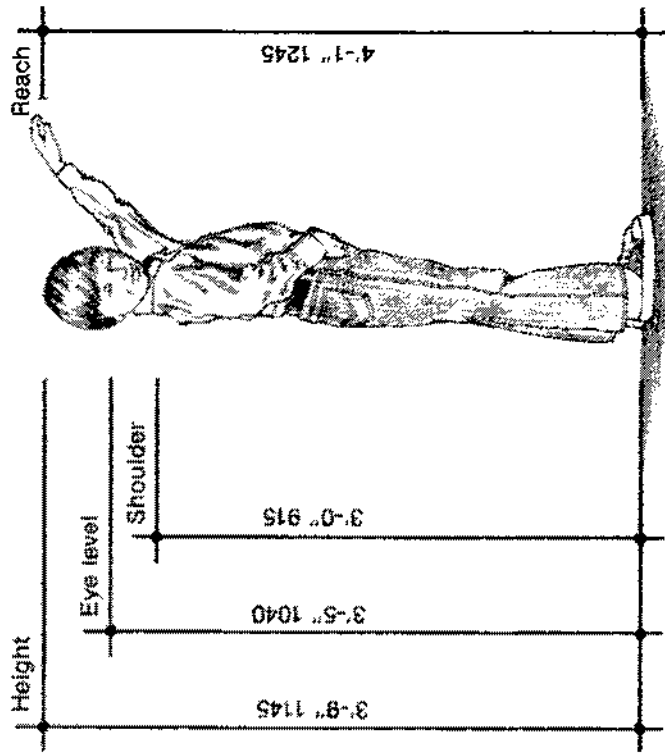


Figure 2.5 C  
Average male first grade student

## **CHRONIC RESTRICTIVE CONDITIONS AFFECTING AGILITY, STAMINA AND REACTION TIME**

Many chronic restrictive conditions affect agility, stamina and reaction time. Those with cardio-vascular and cardio-pulmonary diseases, respiratory diseases, hypertension and degenerative conditions are included in this category, as well as the elderly, who may be affected in various ways by the physical changes brought about by aging. People with multiple disabilities may have difficulty with agility, stamina and reaction time.

In any physical environment, many elements are included that require a person to be strong and agile, and to react quickly. Examples include the use of revolving doors, escalators and street crossings. The typical controlled street crossing requires a person to see and understand the traffic lights, stand and wait for the lights to change, react to the change from red to green, negotiate the curb, walk in a congested group, in some cases cross a very wide street, react to traffic turning through the pedestrians' crossing, maneuver to avoid manholes or defective surfaces in the path of travel, and, on reaching the far side, climb up the curb to the safety of the sidewalk. In many cases the time allowed to carry out this sequence of tasks is based on the time required by the 50 percentile. Expressed another way, one half of the population do not have enough time to cross most streets safely. The environmental conditions combined with their own physical characteristics can create many difficulties and slow them down.

Time and space should be allowed for slower moving people to react to situations, especially where automatic information or signals are given. Places for resting should be included wherever possible. Where heavy pedestrian concentrations are expected, extra space is needed to allow for maneuvering past slower pedestrians and those using crutches or walkers. Rest areas should be provided outside of the main pedestrian flow.

Spaces, as large as possible, should be provided at the approaches to all stairs, for reasons stated in the previous paragraph.

Although elevators serve the needs of wheelchair users, it should be remembered that they serve the needs of all people, particularly those with mobility limitations.



Photo: Mayor's Office for Senior Citizens and the Handicapped, Chicago

The normal aging process affects people in a variety of ways and to various degrees. While some may be subject to multiple disabling conditions earlier than some, others retain full use of their facilities well into old age.

**SEVERE AUDITORY IMPAIRMENT**

This category includes those who cannot hear and understand spoken words and those who can hear and understand a few words.

According to the 1972 National Census of the Deaf Population, there are 13,400,000 deaf and hard of hearing persons in the USA. Of these, 1,767,000 are functionally deaf and can neither hear nor understand speech, with or without the use of hearing aids. Of those, 400,000 are prevocally deaf, or become deaf before 19 years of age, and 200,000 are prelingually deaf, or become deaf before the age of three. As with blindness, the aging process can affect hearing. This hearing loss is called presbycusis and is a progressive loss of hearing with symptoms not usually apparent until a person is over 65 years old. The effects of presbycusis are the inability to hear high frequencies and a reduced ability to hear sounds in general. Word sounds above 2,000 cycle frequency become unintelligible or not heard. Increasing the loudness of speech does not result in a better understanding of what is being said. Persons with presbycusis may be labelled inattentive or senile. Background noises also interfere with an hearing-impaired person's ability to hear a normal conversation. One of the major problems facing all deaf people is not their hearing loss, but the lack of public understanding of what deafness really is. The deaf person frequently lives in an isolation not penetrated by society even for purposes of communicating life-saving emergency warnings.

The normal frequency range of audition for adults is approximately 10½ octaves, from 15Hz, to just over 20,000Hz. Many people with severe hearing decrements across a wide range of frequencies cannot hear audible signals. Appropriate emergency communication systems are a critical need for deaf people. Audible warning systems must be accompanied by visual warning systems or other redundant cueing aids.

Signage in the built environment is important for the auditory impaired and speech impaired. It is very difficult to get the general public to respond to written questions, or to listen attentively to a person with speech impairment, because they may perceive this disability to be a mental deficiency as opposed to a physical impairment. Embarrassment or impatience by the hearing person usually results in a lack of communication. The difficulties and frustrations encountered by a deaf person endeavoring to locate a toilet, for instance, cannot be imagined by most hearing persons.

The profoundly deaf person cannot use telephones and has to travel to relay messages. Teletypewriters conveniently located in specific downtown public buildings available to all deaf people with similar equipment at home would greatly increase long distance communication between their families and friends. These machines type out the telephone messages. Many hearing impaired persons can use a telephone if it is equipped with an amplifier.





Photo: Mayor's Office for Senior Citizens and the Handicapped, Chicago



## SEVERE VISUAL IMPAIRMENT

This category includes persons who cannot read ordinary print even with the use of eyeglasses, those with legal blindness (20/200) or who have a field defect of 10% or less, and those who are totally blind.

The elderly figure very prominently in the statistics of the visually impaired, having a higher rate of blindness than any other age group. According to one estimate, one person in every thousand persons 20-44 years of age is legally blind, but for those 85 years and over there is a dramatic change, with one person out of every twenty-seven persons legally blind. As one gets older, there are irreversible physical changes which are not related to disease or accident. The changes in vision accelerate after age 50 and increase in severity in the years following 65. The result of these physical changes can be identified with a variety of problems. It becomes more and more difficult to see objects clearly, and the ability to focus on objects at different distances decreases. It takes longer to change focus from an object close at hand to another further away. As a person gets older, an increase in illumination is required to carry out tasks; approximately three times as much light is required for an 80 year old to read a book than that needed by a teenager. However, the increase of light level results in attendant problems caused by the increase in the amount of glare. Thus, considerable care must be exercised to insure evenly distributed or balanced light sources. When elderly persons move from a light to a dark area or vice versa, their sight recovery is delayed much longer than that of younger persons, and they may not be able to see hazards in the route, such as steps. Light levels between different areas should be gradually changed. With age, the lens of the eye becomes increasingly rigid and opaque, and gradually yellows. This affects the ability to discern color intensities clearly, particularly colors that are closely related, especially the blue-green end of the color spectrum. One effect of this is a decrease in ability to judge distances. For example, an elderly person using a stairway where walls, landing and steps are of the same color value may find himself unable to differentiate between the elements. These difficulties are all a result of normal age related vision losses.

This is a simulation of an interior of a shopping mall as it appears to an elderly person with vision impairment. The shadows are so dark that projec-



tions or changes in level cannot be seen. Glare off the floor is also a problem. Signs cannot be clearly seen or read and colors appear washed-out.

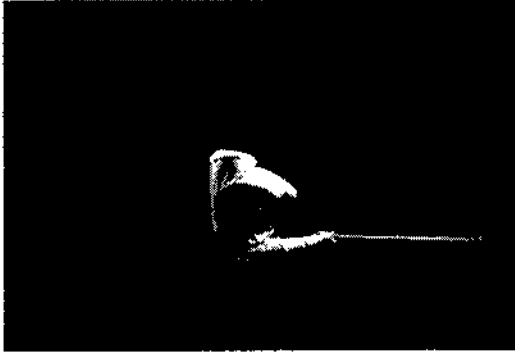
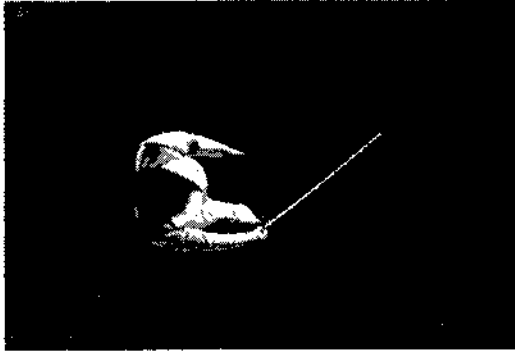
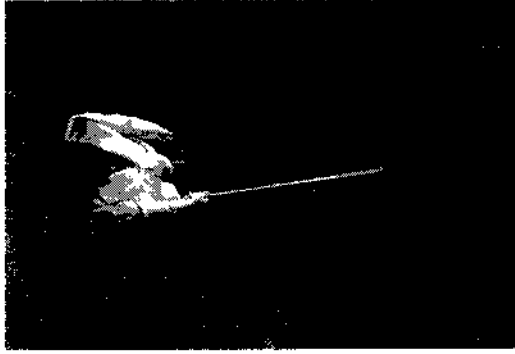
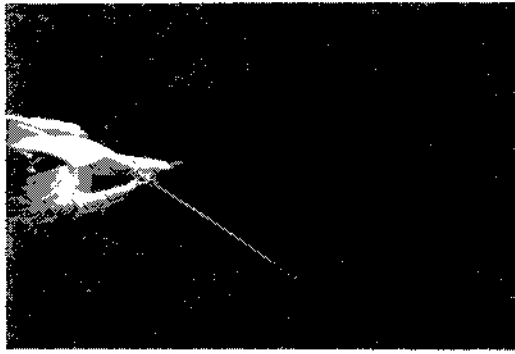
Photo: Dr. Leon A. Pastalan,  
Institute of Gerontology  
University of Michigan,  
Wayne State University

The gradual loss of vision may be subconsciously compensated for during the years, moving closer to the television for example. Persons will rely on whatever degree of sight that is left for their daily living activities. They may have more mobility problems than those who are totally blind, because those without sight rely on an aid, a long cane, or a dog guide trained to recognize and avoid hazards.

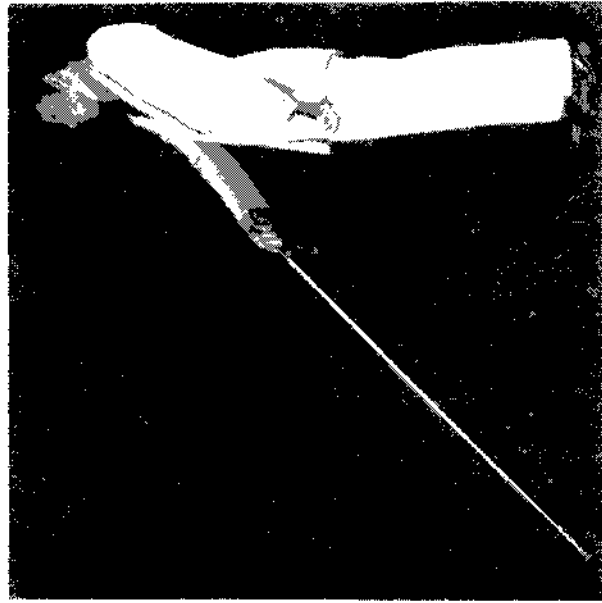
### 2.8.1

#### LONG CANE TECHNIQUE

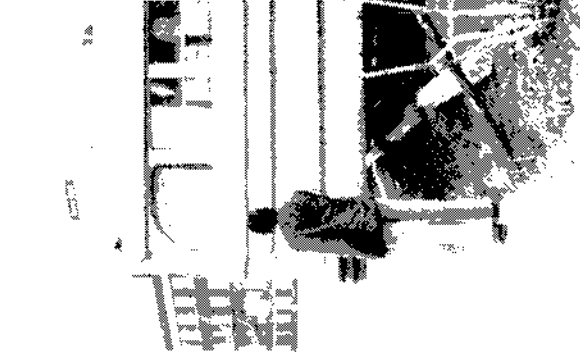
Most people who are severely visually impaired use the long cane as a mobility aid. There are two main techniques, one consists of the touch technique, where the cane sweeps from side-to-side and touches points outside both shoulders; the other consists of the diagonal technique, where the cane is held in a stationary position across the body with the cane tip touching the ground at a point outside the left shoulder and the handle extending to a point outside the right shoulder (reverse for left handed people). The touch technique is used outdoors and indoors, but the diagonal technique is used primarily indoors. The long cane technique is successful only if hazardous objects can be detected in the range of the cane, see Figure 2.8.1. When approaching an object, an overhang of 1'-0" can be detected if it is no higher than 2'-3" from the floor surface. When walking alongside projections, they cannot always be detected, though objects projecting not greater than 4" are not considered hazardous because the blind usually walk away from the edge of a path.



The long cane technique is used to determine obstacles in the path of travel.



The white cane can detect obstacles in the path of travel if they fall within 2-3' approximately from the floor or ground surface.



Often obstacles cannot be detected.

Photo: Michael A. Jones

The environment has traditionally been designed by sighted people, and therefore oriented solely towards their needs. Without the ability to use the visual sense, some blind people find themselves isolated from the rest of society and unable to compete in it. Others are totally self-sufficient and lead full, enjoyable and productive lives. Self-sufficiency is linked to personal mobility, and it is the fear of negotiating alone through an apparent hostile environment that intimidates, and therefore isolates, some blind people.

Blind people can negotiate independently most complex or confusing environments. They are educated to guide themselves to their destination by using a cognitive mapping process of "landmarks" and "shorelines" within the environment. A series of familiarization sessions are taken along a particular route, and the "landmarks" and "shorelines", more commonly referred to as blind location cues, are pointed out to a blind person by a parapathologist or orientation and mobility specialist. Location cues, such as bus stops, sign posts, building facades, driveways, changes in paving textures and curbs, are learned so that a mental visualization of the route is obtained. This visualization combined with the senses of sound and touch are utilized to navigate through the environment. This Standard requires blind location cues in places where they are most needed, such as at the top approach to a flight of stairs or where a vehicular area abuts a walkway.

Since the existing environment contains a wide variety of paving materials, a standardized system of tactile cues would be difficult to implement, and is, therefore, not proposed. However, where such devices are used in a building or facility, they shall remain constant throughout that environment. Tactile cues on the walking surface can be perceived when using the long cane technique and by feeling the difference in texture when walking over them. Studies have demonstrated that 4" wide tactile guidestrips can be easily located and used by blind people. They are particularly successful when used on oblique pedestrian crossings and

on sidewalks containing a proliferation of street furniture. More traditional methods of construction are also valuable, for example, a pea gravel finish to concrete paving alongside a brushed concrete walk can easily be detectable and clearly defines the walkway. This device is extremely valuable if street furniture is located within this textured border. Besides textural changes, changes in hardness of the surface material also serve as excellent location cues. For instance, ribbed rubber tiles placed in a circulation route predominantly surfaced with carpet or vinyl asbestos tiles can be easily perceived. Care must be taken to make sure that such textural changes, or changes in hardness, do not interfere with mobility for people in wheelchairs.

Color changes must also be considered along with textural and hardness changes, so that persons with low vision also have the benefit of such cueing aids. It must be remembered that whatever small degree of vision a person has will be used in negotiating the environment.

A ramped surface can also serve as a cueing device. Care must be taken to ensure that a blind person is not placed in a vulnerable situation if the ramp blends to a common level with the horizontal surface at too gradual a rate. In this case, a textural surface change must be provided.

Hand locatable tactile warnings must be positioned predictably for the hand sweep of a standing person, for example, tactile room identification shall be consistently located in the range of 4'-6" to 5'-0" from the floor.

As approximately ten percent of the blind population use braille, its use as a redundant cue in the environment at large is limited. Raised arabic characters can be read by the sighted, partially sighted and those who are totally blind. Therefore, raised characters eliminate the necessity for two systems of communication. Letters shall be a minimum of  $\frac{5}{8}$ " high, raised  $\frac{1}{32}$ ", and be of contrasting color to the background, preferably a light color on a dark background.

Audible cues benefit those who have severe vision impairment. Audible signals sounding once for the "up" direction and twice for the "down" direction of elevators are good examples of this type of cueing for the visually impaired. Verbal annunciators are also effective.

Raised letters can be 'read' more easily than recessed letters. Persons who lose their vision because of diabetes also tend to lose their sense of touch.



Photo: Michael A. Jones



Photo: Michael A. Jones

The change in texture provides the blind with an orientation/mobility cue. The textured strip is also used to locate planting and furniture as well as providing a barrier between the pedestrian and vehicular circulation routes.

## 2.8.3

### COLOR BLINDNESS

The eye and the brain work together to provide us with the sensation of color. The eye has light sensitive nerve cells called "rods" which are sensitive to light but not color. They give perception of white, black and grey. While they are sensitive to very low levels of light, they are all but incapacitated at high levels of illumination. The color receptors of the eye, known as "cones", are closely packed in rod-free areas located in the center of the retina. Optic nerves send messages to the brain where the color is "seen". When one or more sets of the receptors are weak or malfunction, color blindness occurs. It is a hereditary characteristic which cannot be remedied. Complete color blindness is extremely rare, and less than 1 percent of the population have yellow-blue color blindness. The most common color defect is red-green deficiency, which is also common among the elderly as previously mentioned. Because of the numbers of people who are color blind, warnings must be accompanied by shape. For instance, hall lanterns which indicate the approach and destination of elevators should be directional.

## 2.9

### OBVIOUS CONFUSION AND/OR DISORIENTATION

This category includes persons who have problems with the perception and interpretation of the environment, including the senile, the emotionally disturbed, the mentally ill, the mentally retarded, and those who are temporarily confused and/or disoriented when they find themselves in new or strange situations. It is estimated that this population is between 18 and 23 million.

Approximately 89 percent of all mentally retarded people are only mildly retarded, and 6 percent moderately retarded. The mildly retarded are usually capable of learning to do productive work and live independently as self-supporting members of society. With training, the moderately retarded can also care for themselves and become partially self-supporting.

Education for mentally retarded children is slower paced than for children in general, but like other chil-

dren, they experience an increase in learning ability as they grow older. How much they learn is not predictable and, for some, the highest reading attainment may be to recognize signs like STOP and DANGER. For this reason, the use of words used as warnings or directions in the environment should receive great care. For example, a retarded person might learn which washroom to use by the length of the words on the doors—MEN or WOMEN. Confusion is likely to occur when the words on the doors are GENTLEMEN and LADIES because the length of the words has been reversed. Among the typical instructional objectives taught to mentally retarded people are skills for safe living at home and in the community, attaining literary and basic communication skills, using current technology and services such as transportation systems, banking, etc., as well as skills for earning a living. Complicated environments produce unnecessary difficulties for many people which may affect their self worth and happiness. In 1966, approximately 19 million people suffered from mental or emotional illness, of which approximately half a million were children.

The problems experienced by this group of people include the interpretation of information, the garbled or too quickly enunciated PA systems, printed instructions, flashing signals and poorly designed graphic symbols. Buildings and facilities with long and difficult circulation routes are confusing, and also make it difficult to retrace the route. This is also true of buildings which have symmetrical plans. Because of the similar appearance of each route, finding a specific area may be difficult. In some cases, people may fear walking down long anonymous or repetitious corridors, steep stairs or even across access covers in walks. Some people also fear walking below cantilevered structures for fear they will fall. Conversely, others may not be aware that they are in a dangerous situation, such as a dimly lit parking lot or obscured street crossing.

The research into the effects of the environment on mental health is relatively new. As more knowledge becomes available, additions or changes to these standards may be necessary.

## 2.10

### **DIFFICULTY BENDING, TURNING, SITTING, KNEELING AND RISING**

This category includes people with severe arthritis, chronic back conditions, congenital deformities and those in braces. Also included are the temporarily disabled such as some pregnant women or those wearing casts.

Over half the adult population suffer with back problems at least once in their lives. Able-bodied persons with physically active jobs are more prone to problems than those with sedentary occupations. Bending the back produces unequal distribution of forces on the vertebrae discs. Strain increases if the body bends forward at the hips or trunk. Conditions should be created that minimize the need for persons to bend. Similarly, conditions must be created to minimize the need for twisting or turning, particularly for those in wheelchairs. For example, elevator buttons placed on the "door wall" of a small elevator can be operated by a person in a wheelchair only by twisting his body, stretching his arms and turning his head 90° or more to see which button to press. Persons with neck problems may not be able to look upward to read signs or symbols positioned above their head.

Many persons have difficulty sitting and rising, particularly if no arm rests are provided to aid the person. Frequently, the edge of a table is used to assist rising, and if the table top is only supported on a center pedestal, adequate support may not be provided. Grab bars provided in accessible toilets will be used by people having difficulty in sitting and rising.

## 2.11

### **INCONTINENCE**

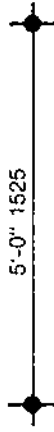
People who have limited bladder and bowel control, or who cannot control their bodily evacuative functions, may be severely restricted in their mobility. Many of them are home bound, restricted to short journeys from their homes, or restricted to places where known public accessible toilet facilities exist. The physical and psychological problems of communicating with

a stranger for the whereabouts of public washrooms are very real, and the absence of such facilities, readily available to the general public, compounds the problem. Vandalism and mugging are cited as a reason for the non-provision of these facilities, though crime in other elements of the built environment, such as in stair-towers or elevators, does not prevent their inclusion in a building. The siting of washroom facilities so that they can be "policed" by the public can reduce the problem of crime.



Most of the pages are laid out in a specific manner. The first column contains problem statements made by disabled persons concerning their difficulties with the built environment. Occasionally, photographs illustrating certain problems also appear. The second column contains the Standards. The right hand page contains drawings and photographs which graphically illustrate the Standards.


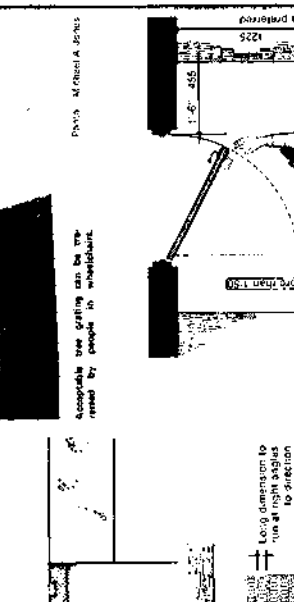
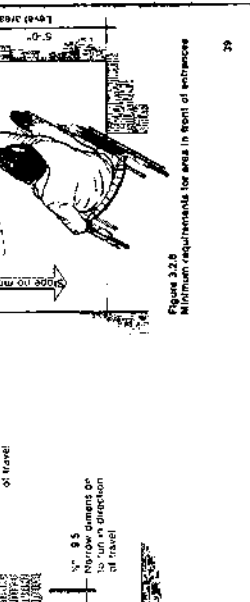
Dimensions are shown in feet and inches and metric units—millimeters (mm).



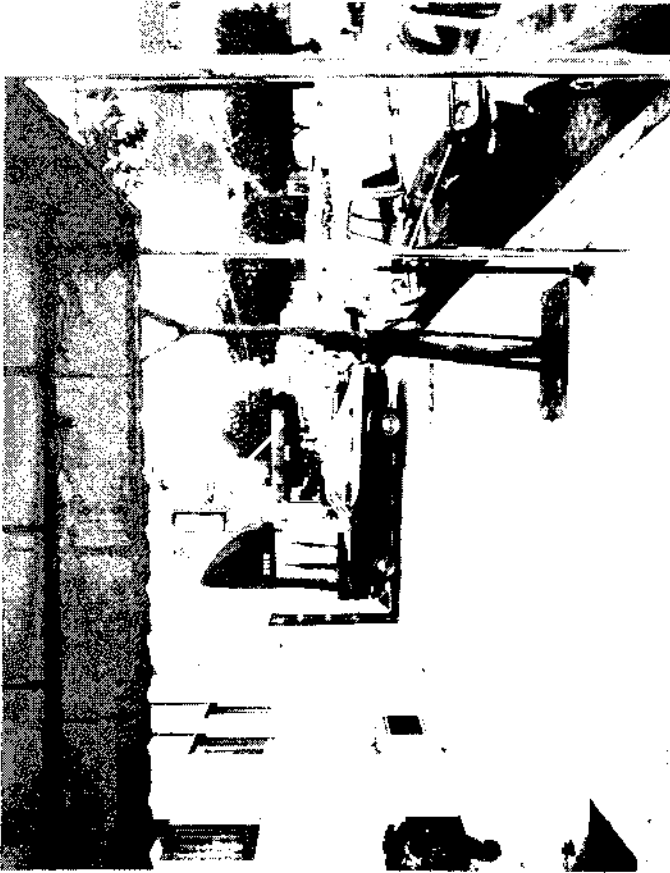
PROBLEM STATEMENTS

STANDARDS

GRAPHIC ILLUSTRATION OF STANDARDS

<p><b>3.2.4</b></p>  <p>Trees or other objects which project over the sidewalk at a corner, intersection, or other location where a person is likely to be crossing the sidewalk, shall be removed or trimmed so that they do not project over the sidewalk.</p>	<p><b>3.2.4</b> Walls with groutless sleeper joints shall be constructed as follows: and conform to the requirements of Section 5.1, Gratings, and Section 5.2, Entrances and Exits. Groutless joints on walls shall not be located within 1'-10" of the edge of the wall.</p> <p><b>3.2.5</b> Walls with sustained gradients of no greater than 1:20 shall have level areas of at least 5'-0" in length at approximately 100'-0" intervals for the purpose of rest.</p> <p><b>3.2.6</b> The cross slope of crowding of walks shall be between 1:50 and 1:100. Where very high sidewalks, ramps, or other walkways are used, the cross slope shall be 1:50.</p>	<p><b>3.2.7</b> Gratings, ramps, and other access covers shall be placed so that they do not obstruct the path of travel. Where they must occur, they shall be placed so that they do not obstruct the path of travel. Gratings shall have a maximum clear opening of 1/2" in the narrow direction and the long dimension shall be at right angles to the direction of pedestrian travel along the walk. See Fig. 3.2.7. Solid covers occurring in walks shall not have changes in the vertical surface direction from one side to the other.</p> <p><b>3.2.8</b> Walls shall preferably be level at building entrances, but where drainage is required the area in front of the door may be sloped no more than 1:50. This area shall extend at least 1'-6" beyond the handle side of the door and be a minimum of 5'-0" in depth from the face of the door. See Fig. 3.2.8.</p>
<p><b>3.2.7</b></p>  <p>Figure 3.2.7A High grating openings maximum size opening in the narrow dimension</p> <p>Figure 3.2.7B Solid manhole covers</p> <p>Figure 3.2.7C Layers of grating which occur in walls</p>	<p><b>3.2.7A</b> High grating openings maximum size opening in the narrow dimension</p> <p><b>3.2.7B</b> Solid manhole covers</p> <p><b>3.2.7C</b> Layers of grating which occur in walls</p>	<p><b>3.2.7</b> Gratings, ramps, and other access covers shall be placed so that they do not obstruct the path of travel. Where they must occur, they shall be placed so that they do not obstruct the path of travel. Gratings shall have a maximum clear opening of 1/2" in the narrow direction and the long dimension shall be at right angles to the direction of pedestrian travel along the walk. See Fig. 3.2.7. Solid covers occurring in walks shall not have changes in the vertical surface direction from one side to the other.</p> <p><b>3.2.8</b> Walls shall preferably be level at building entrances, but where drainage is required the area in front of the door may be sloped no more than 1:50. This area shall extend at least 1'-6" beyond the handle side of the door and be a minimum of 5'-0" in depth from the face of the door. See Fig. 3.2.8.</p>
<p><b>3.2.8</b></p>  <p>Figure 3.2.8 Minimum requirements for area in front of entrance</p>	<p><b>3.2.8</b> Minimum requirements for area in front of entrance</p>	<p><b>3.2.8</b> Walls shall preferably be level at building entrances, but where drainage is required the area in front of the door may be sloped no more than 1:50. This area shall extend at least 1'-6" beyond the handle side of the door and be a minimum of 5'-0" in depth from the face of the door. See Fig. 3.2.8.</p>





**A typical sidewalk is hazardous to all pedestrians. Here projections into the circulation path, posts, trees, manhole covers, changes in the sidewalk surface and parked cars have to be negotiated.**

Photo: Michael A. Jones

### 3.1

## EXTERIOR CIRCULATION ROUTES

Careful site development is the most effective and usually the most economical means of resolving the problems of accessibility. These Standards require access to the full range of facilities provided for the public, including access to and across the site to accessible entrances, gardens, recreational facilities, parking and also interior courtyards or gardens. The siting of facilities, grading, parking, and the routes of walks shall provide convenience, safety and unrestricted movement of people and vehicles.

### 3.1.1

There shall be at least one path of travel that shall have no steps or slope greater than 1:12 from at least one site access point to the major entrances of buildings and facilities. This route shall be as direct as site conditions allow.

### 3.1.2

The grading of the ground shall insure level or gradually sloped pedestrian access routes to all facilities.

**Note:** Studies at Wright State University School of Medicine in Dayton, Ohio, reveal that the manually operated wheelchair is only 5% efficient in terms of work performed per quantity of oxygen consumed. Ordinary walking has a 25% efficiency. Because of the work expenditure for persons in wheelchairs, level routes or routes with slopes that are below the maximum allowable are preferable to shorter routes which have a maximum sloped ramp.

### 3.1.3

Where parking is provided, spaces for disabled drivers shall be those that are closest to the accessible entrance of the building served.

### 3.1.4

If moving walkways are provided, they shall be wide enough to accommodate a wheelchair and have a minimum clear width of 3'-0".

Parking spaces are often located too far from the destination. Excessive, and thus exhausting distances have to be travelled by disabled people with stamina limitations.



Gently rolled gutters define parking and pedestrian areas and are accessible to people and vehicles.

Photo: Michael A. Jones



When accessibility is a component of the initial design phase, the approach to the entrance satisfies the needs of everyone.



Stairs, ramps and sloping walks may be required on sloping sites.

If sidewalks are not provided, it is dangerous for pedestrians, handicapped or otherwise, to travel on the road. Water flowing in the gutter forces pedestrians to encroach even further into the road.

### 3.2

#### **WALKS, SIDEWALKS**

Walks and sidewalks shall be designed to allow free movement of pedestrians to site facilities and adjacent streets, to allow passing of pedestrians using the walks and shall be free of hazards.

Crowds of pedestrians on narrow sidewalks restrict those with gait problems or those who use wheelchairs from maneuvering with ease or safety.

### 3.2.1

The minimum clear width of walks and sidewalks shall be 3'-0". Where the incidence of people in wheelchairs or those using walking aids is high, such as at health facilities, special housing, etc., the minimum width of walks shall be 5'-0". Walks less than 5'-0" wide shall have places wide enough for two wheelchairs to pass and be 5'-0" minimum in width and 7'-0" minimum in length occurring at intervals not to exceed 100'-0".

Irregular or loose surfaces, such as gravel, sand, grass or dirt, are difficult or impossible for some people to negotiate, especially those who are semi-ambulatory and those in wheelchairs. These surfaces can affect balance and hinder progress, making travel hazardous.

### 3.2.2

Walks and sidewalks shall be of a continuing common surface, not interrupted by abrupt changes in level. Surfaces shall be firm and stable and shall not present slipping hazards.

Moving over jointed surfaces, such as brick or concrete pavers, may cause people in wheelchairs much discomfort. For those with neurological disorders, the bumping can cause headaches or dizziness. Sudden jolts can cause spasticity in a person severe enough to induce an involuntary jump out of the wheelchair.

### 3.2.3

Large areas or long stretches of small unit components, such as brick and stone, shall not be used on accessible pathways unless the components are laid on a firm base, and the joints do not exceed 1/2" in width and are flush with the adjoining surfaces.

Surfaces with uneven joints can be a tripping hazard for anybody, but for the semi-ambulatory they are particularly hazardous. Uneven joints can also deflect or stop the caster wheels of a wheelchair, sometimes causing a person with little or no trunk balance to slump or even fall out.

Joints in paved surfaces collect water which may freeze and make the surface slippery. Moss or weeds growing in joints may also create a slippery surface or a tripping hazard.

Textural surface changes provide location cues for the blind.

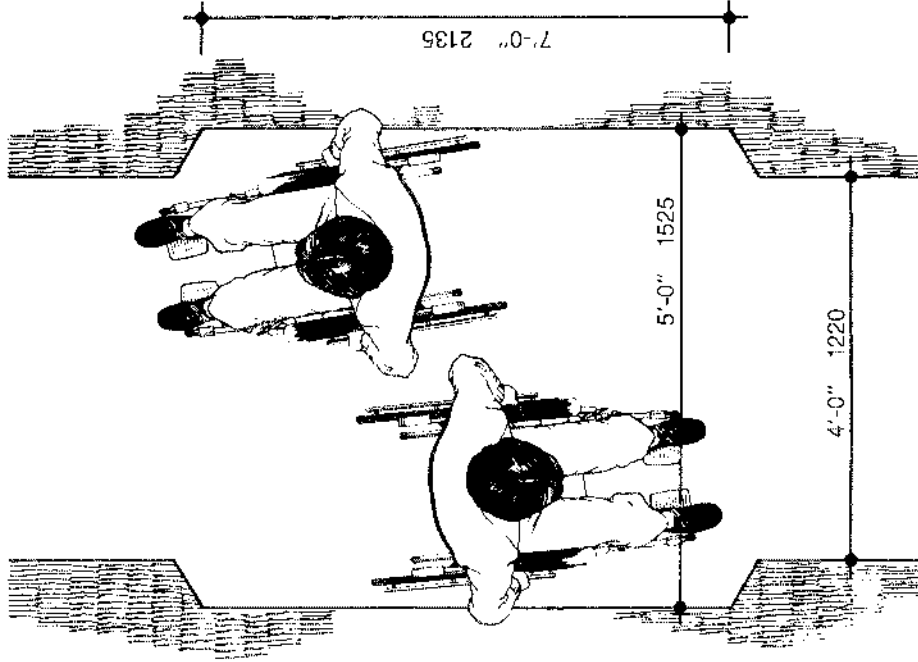


Figure 3.2.1  
Minimum dimensions of passing areas in walks  
less than 5'-0" wide

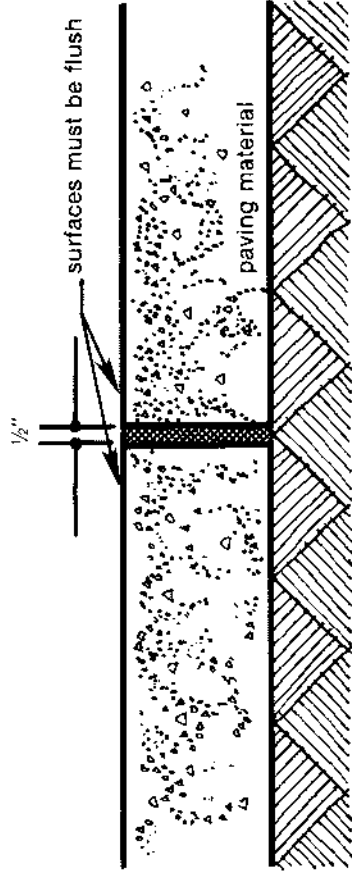


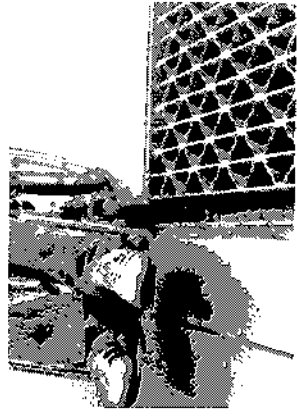
Figure 3.2.3  
Section through paving showing maximum width of  
joints allowable



Trace on paper made by a person in a wheelchair wheeling over a sloping sidewalk at a driveway entrance. The person is continually compensating to correct the chair's natural inclination to run down the slope.

It is difficult to travel in a straight line when sidewalks and walkways slope to one side. The effort in compensating for the wheelchair's inclination to run down the slope is exhausting for most people. The blind sometimes veer down the slope and, if there is no curb, they could inadvertently walk into the road. When it is dark, deaf persons with a defective balance mechanism may have difficulties walking in a straight line on sloping surfaces. Excessive slopes often occur where driveways cross sidewalks. Occasionally, the cross slope for drainage on a sidewalk is greater than necessary.

Manhole and other access covers with heavily patterned surfaces can trip people with fixed ankle braces or stiff legs, deflect or stop wheels of wheelchairs, and bend or snap canes if they become caught in the indented surface. When wet, they can cause crutches or canes to slip. These hazards often result in falls and injury. Stormwater and other gratings are equally hazardous. Glass pavement lights can be very slippery, especially for those using walking aids. In snowy weather, most of these hazards are hidden from view, so they cannot be detected and avoided.



Joints between gratings and the surround are hazardous.



Heavily patterned manhole covers will deflect the caster wheel of wheelchairs.

Photo: Peter Wachter

### 3.2.4

Walks with gradients steeper than 1:20 shall be considered as ramps and conform to the requirements of Section 6.1, Ramps and Section 6.3, Handrails and Guardrails. Ramps on walks shall not be steeper than 1:12.

### 3.2.5

Walks with sustained gradients of no greater than 1:20 shall have level areas of at least 5'-0" in length at approximately 100'-0" intervals for the purpose of rest.

### 3.2.6

The cross slope or crowning of walks shall be between 1:50 and 1:100. Where vehicular driveways intersect with walks, design priority shall be given to the pedestrian and not the vehicle.

### 3.2.7

Gratings, manhole covers and other access covers shall be placed outside of walks unless site constraints prevent this. Where they must occur in walks, gratings shall have a maximum clear opening of  $\frac{3}{8}$ " in the narrow direction and the long dimension will be at right angles to the direction of pedestrian travel along the walk, see Fig. 3.2.7. Solid covers occurring in walks shall not have changes in the vertical surface dimension that exceed  $\frac{1}{4}$ ".

### 3.2.8

Walks shall preferably be level at building entrances, but where drainage is required, the area in front of the door may be sloped no more than 1:50. This area shall extend at least 1'-6" beyond the handle side of the door and be a minimum of 5'-0" in depth from the face of the door, see Figures 3.2.8.



Photo: Michael A. Jones

Acceptable tree grating can be traversed by people in wheelchairs.

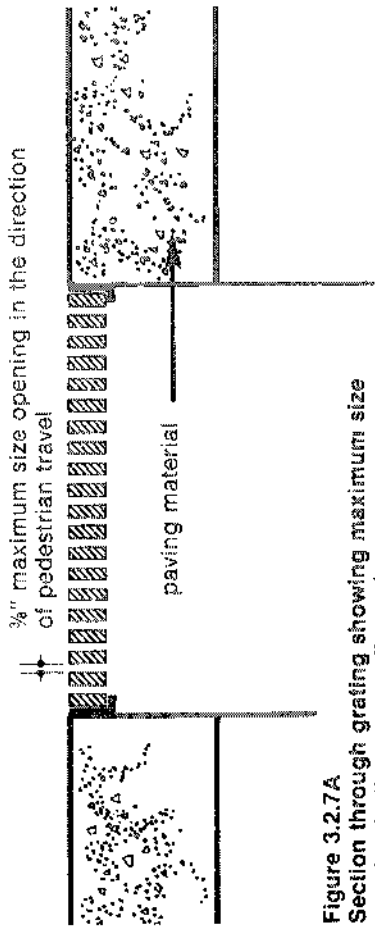


Figure 3.2.7A  
Section through grating showing maximum size opening in the narrow dimension

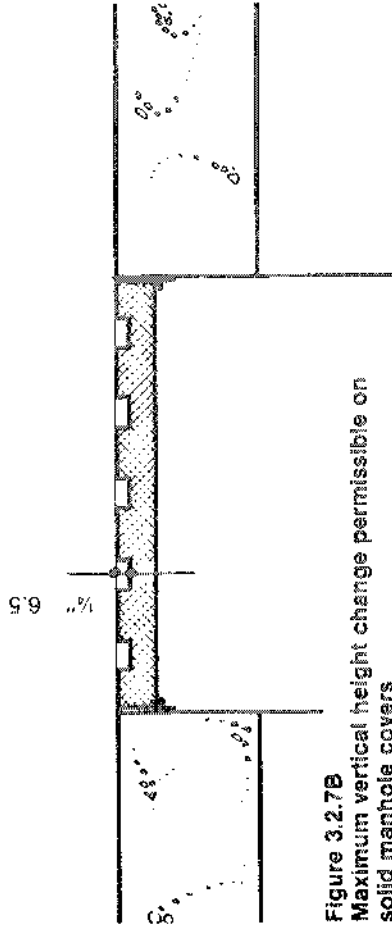


Figure 3.2.7B  
Maximum vertical height change permissible on solid manhole covers

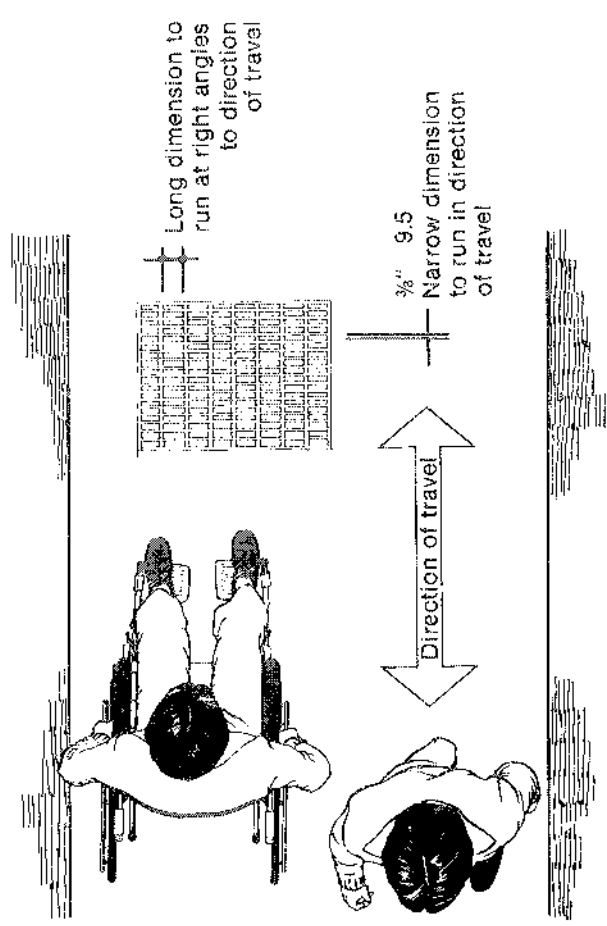


Figure 3.2.7C  
Layout of gratings which occur in walks

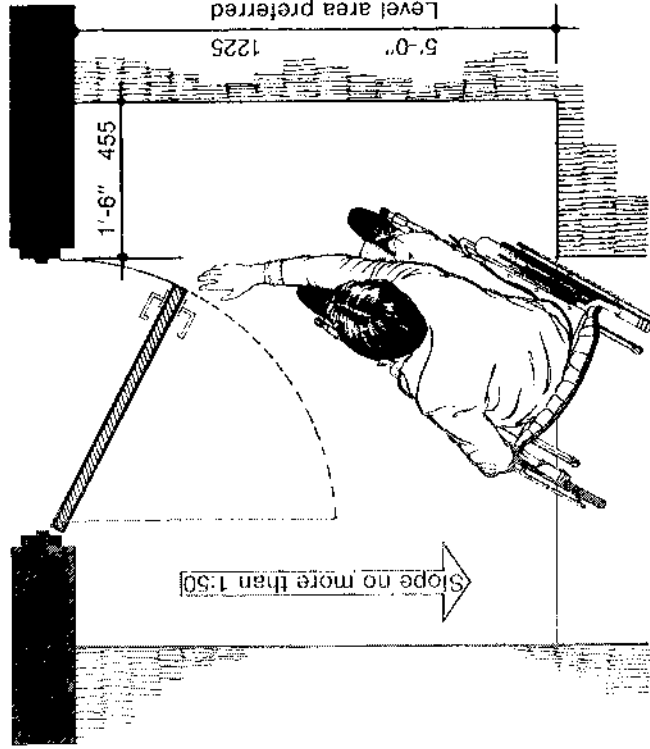


Figure 3.2.8  
Minimum requirements for area in front of entrances

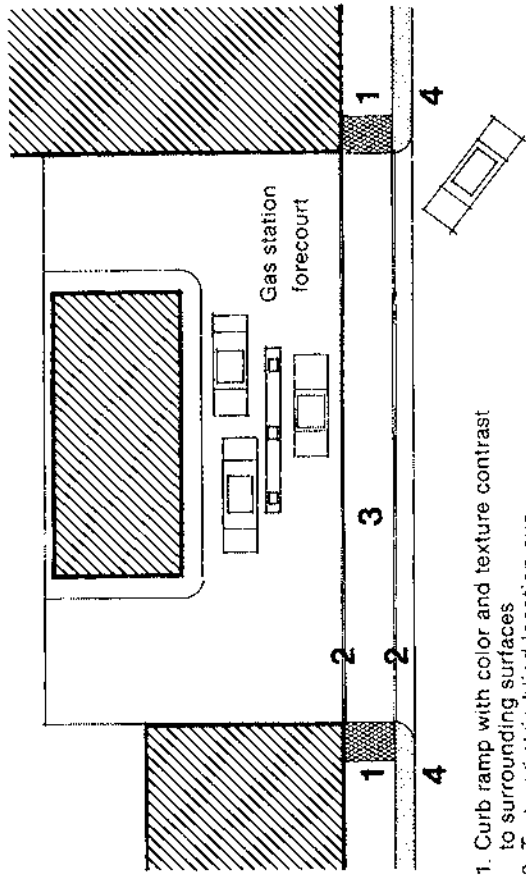
A lack of adequate sidewalk location cues can cause confusion and disorientation among blind pedestrians. If there is no physical barrier, such as a wall or textured surface change at the boundary of a sidewalk and a parking lot, a blind person may inadvertently leave the sidewalk and come into conflict with vehicular traffic.

Insufficient distinction or contrast between the curb edge and the road surface may make it difficult for those with impaired vision to locate the change. This is also true of walks indicated by paint on the road surface, such as occur in shopping center parking lots.

The glare from light colored surfaces makes walking or wheeling hazardous. If there are steps or surface hazards in the route, the glare may prevent them from being seen.

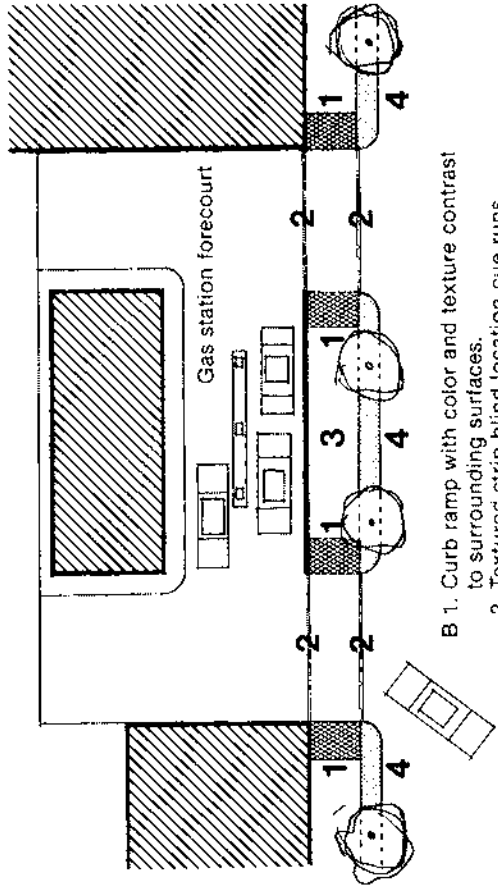
### 3.2.9

When a hazardous area occurs alongside a walk or pedestrian area, a tactile cue, curb or railing shall be provided to warn the blind, and prevent people from inadvertently leaving the walk. See Section 12.3, Tactile Warning Signals and Blind Location Cues, and Figure 3.2.9 for examples of solutions.

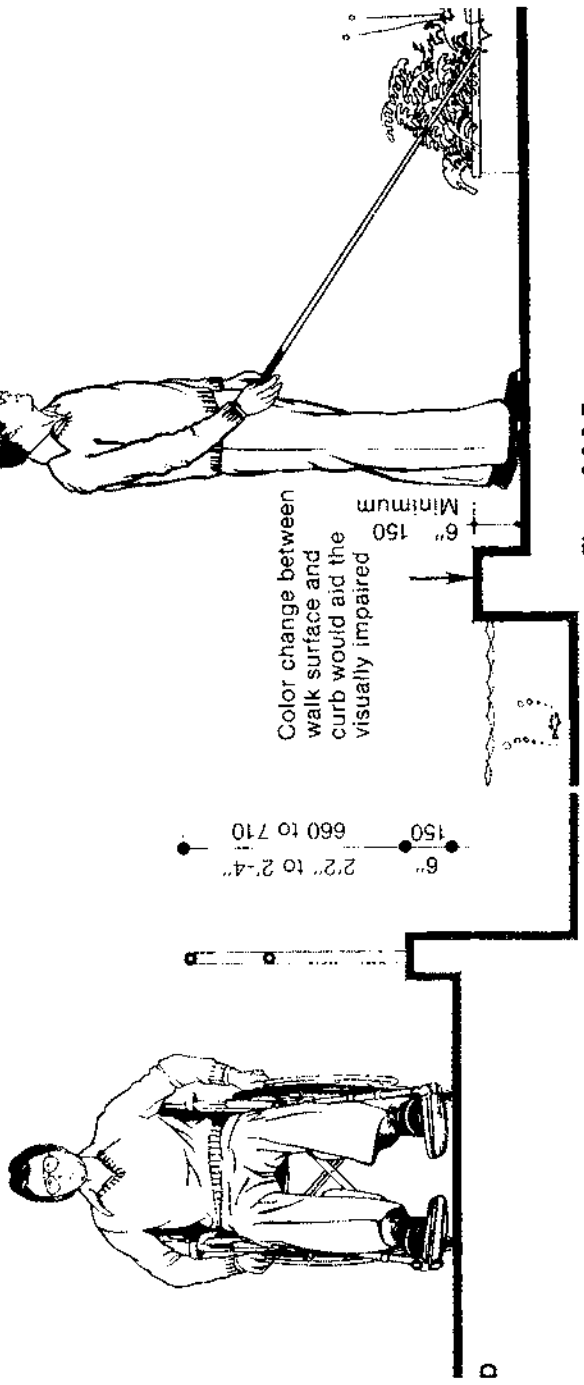
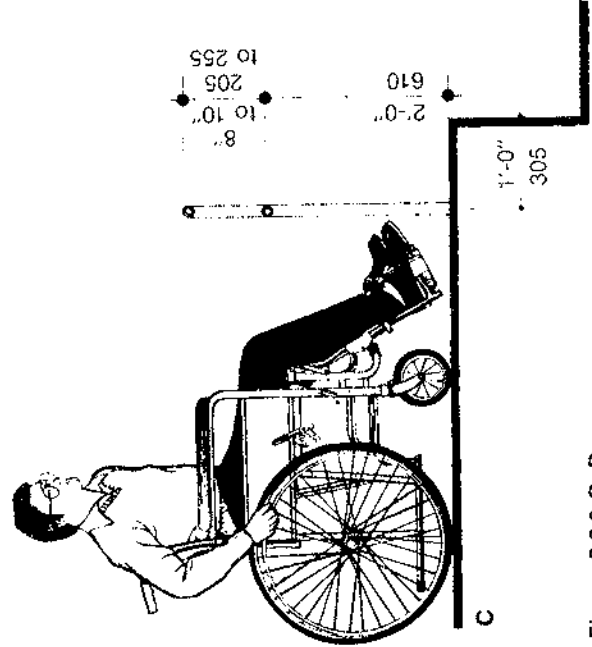


- A 1. Curb ramp with color and texture contrast to surrounding surfaces
2. Textured strip blind location cue
3. Level sidewalk makes walking and wheeling easier and safer
4. Landscaping strip serves as a mobility cue for blind. Posts and other street furniture can be located in this strip. It also serves as a buffer between the vehicular and pedestrian routes, providing a physical and psychological safety zone for all people, especially children and the elderly.

**Figure 3.2.9 A, B**  
**Examples of solutions for location cues to orient the blind**



- B 1. Curb ramp with color and texture contrast to surrounding surfaces.
2. Textured strip blind location cue runs continuously at both sides of the walk to prevent blind and the visually impaired from becoming disoriented.
3. The walk must not slope across the whole width of the forecourt because people in wheelchairs will find it exhausting.
4. Landscape strip or strip with a change in material will serve as a mobility cue for the blind.



**Figure 3.2.9 C, D**  
**Examples of Barriers at edge of hazardous area**

**Figure 3.2.9 E**  
**Locatable barriers around pools and landscaping**



### 3.2.10

No rigid or hard object shall project into the space above a walk lower than 7'-6" measured from the walk surface. Below this height, protruding objects which project more than 4" from a wall or a column must:

- a. continue to the floor; or
- b. to within 8" of the floor; or
- c. be located in protected areas which are recessed or enclosed by wing walls. Such a protected area shall have a contrasting floor texture and color.
- d. Door and door closures do not have to conform to this requirement.
- e. Where low ceiling heights prohibit the placing of Emergency Exit signs above 7'-6" from the floor level, these signs may be placed at a minimum of 6'-6" from finished floor level to the bottom of the sign.

### 3.3

#### CURB RAMPS

Curbs are impossible or difficult to negotiate for everyone in a wheelchair.

#### 3.3.1

Wherever walks and sidewalks intersect with other walks and sidewalks, parking lots, driveways, or streets, the surfaces shall blend to a common level to allow smooth passage of wheelchairs.



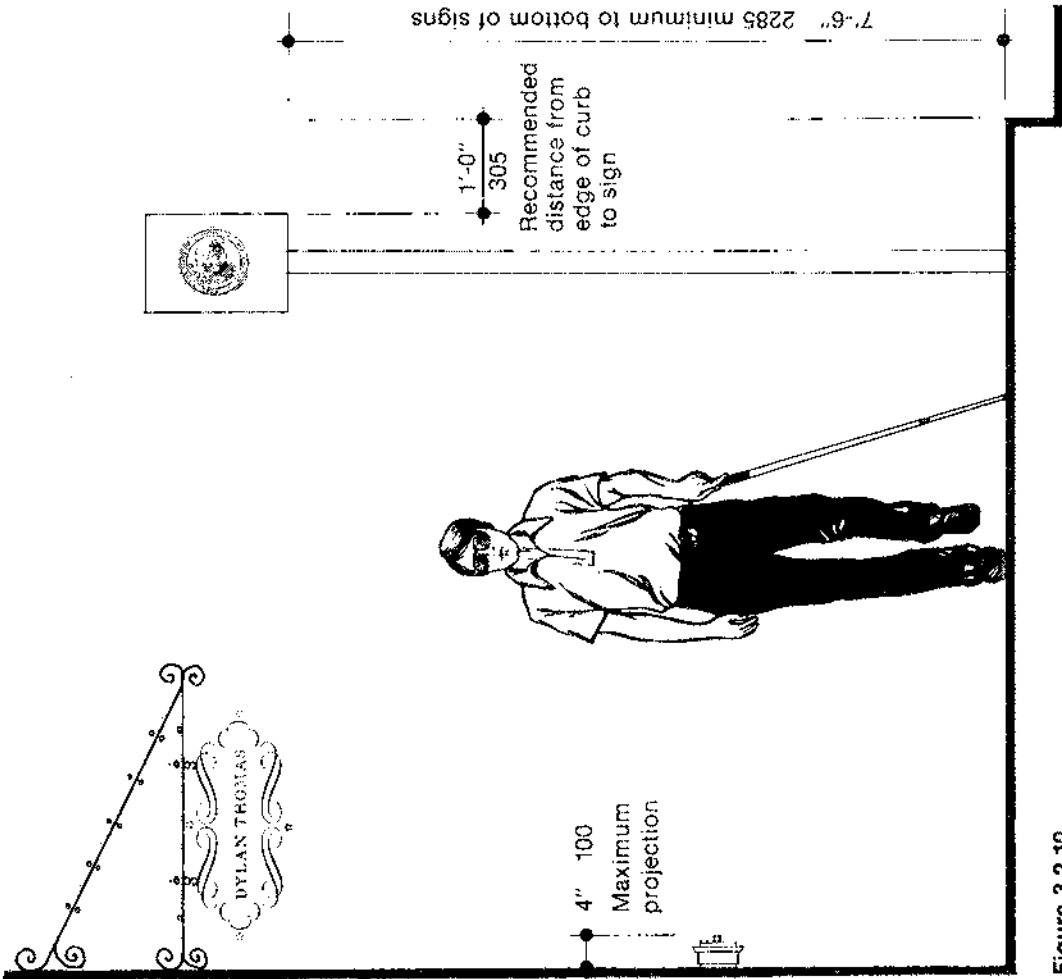


Figure 3.2.10 Requirements for projections above and alongside walks

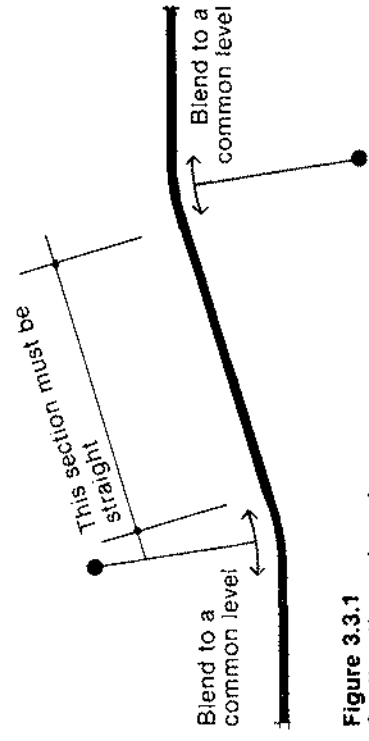


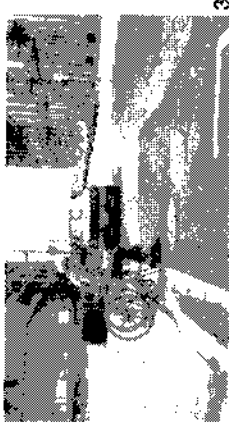
Figure 3.3.1 Section through curb ramp



1



2



3



4



5



6



7

A person with no trunk balance can be pitched out of his chair if it stops suddenly.

This type of accident can be caused by the lip at the bottom of the ramp or by the footrests scraping on the road surface.

Curb ramps are often too narrow to allow wheelchair access.

**3.3.2**

The minimum width of curb ramps shall be 3'-0" measured across the usable surface of the ramp.

Curb ramp slope shall be 1:12 Maximum in new construction. When installed in existing sidewalks, a maximum slope of 1:8 may be used if it is impossible to install a more gradual slope.

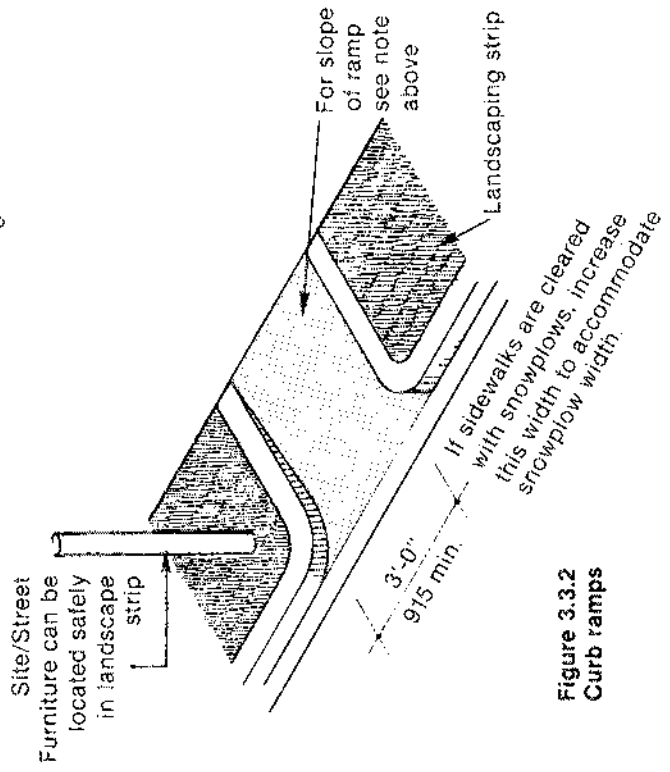
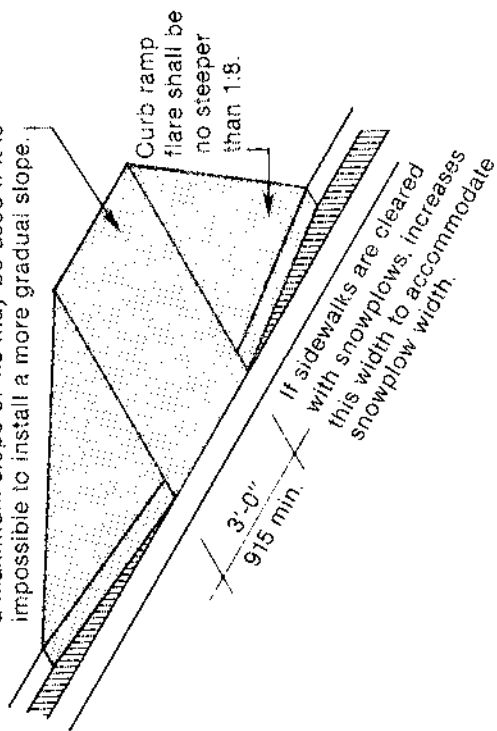


Figure 3.3.2 Curb ramps

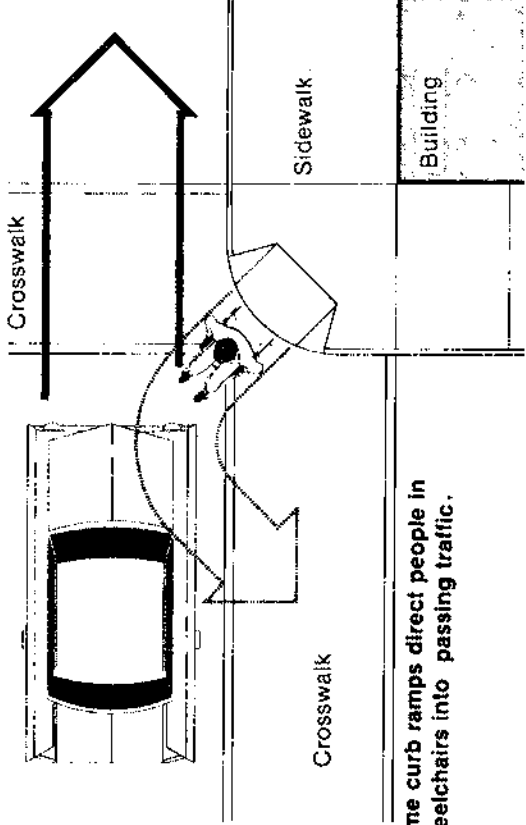
Curb ramps exceeding a maximum slope of 1:8 make it difficult or impossible for some people in wheelchairs to use. Though some may use them by going down backwards, this is a dangerous procedure on busy streets. Some paraplegics with strong arms can descend steep ramps by balancing on the large wheels, but they usually have difficulty ascending.

Where there is a lip at the bottom of a curb ramp, it cannot be negotiated by some people in wheelchairs, especially those with motorized chairs. Such a lip may also tip over a wheelchair and throw the person out onto the road. A small lip is also a tripping hazard to ambulatory people.

If not clearly indicated, a curb ramp may be a hazard for pedestrians who might not notice the vertical or flared sides of the ramp.

Large radius corners may disorient the blind using the curb edge as a location cue, as it is difficult to know where the curve has begun and ended. Curb ramps can add to the confusion because they do not occur in standard locations. A blind person may have to make an assumption regarding the location of a curb ramp. Some are positioned so that they direct people into the crosswalk and parallel with the crosswalk boundaries. Others bisect the corner or occur in random locations causing confusion. A continuous curb ramp around a corner gives poor crosswalk location, and disorients blind people.

Some persons are afraid of using curb ramps that direct them outside of the pedestrian crossing. Where a curb ramp is placed outside of the crosswalk or located so that it bisects the corner, the person using it may come in conflict with moving traffic.



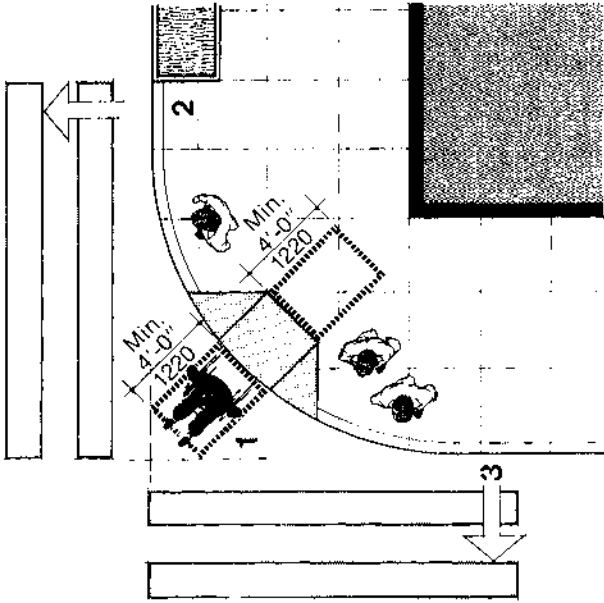
**Some curb ramps direct people in wheelchairs into passing traffic.**

### 3.3.3

Curb ramps shall be no steeper than 1:12. When there is no other way of overcoming the constraints of an existing sidewalk condition, the slope may be increased in steepness, but shall not exceed 1:8. The curb ramp surface shall blend with the street at a common level. There shall be no lip at the bottom of the ramp. The sides of the curb ramp shall not be steeper than 1:8. The whole curb ramp shall contrast in color and texture to the surrounding walk surface. See Table 6.1.1.

### 3.3.4

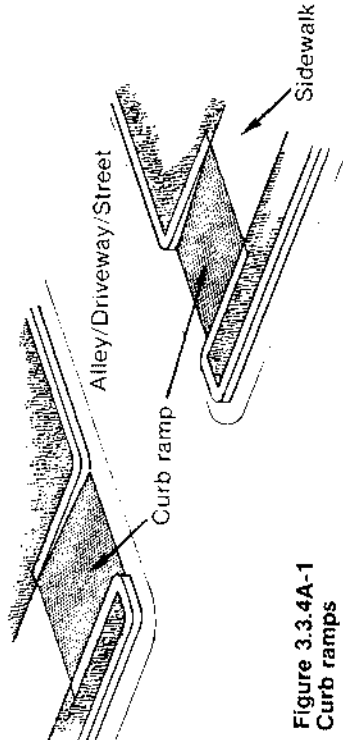
Curb ramps shall be designed so that they direct people into the crossing. See Figure 3.3.4 for acceptable solutions.



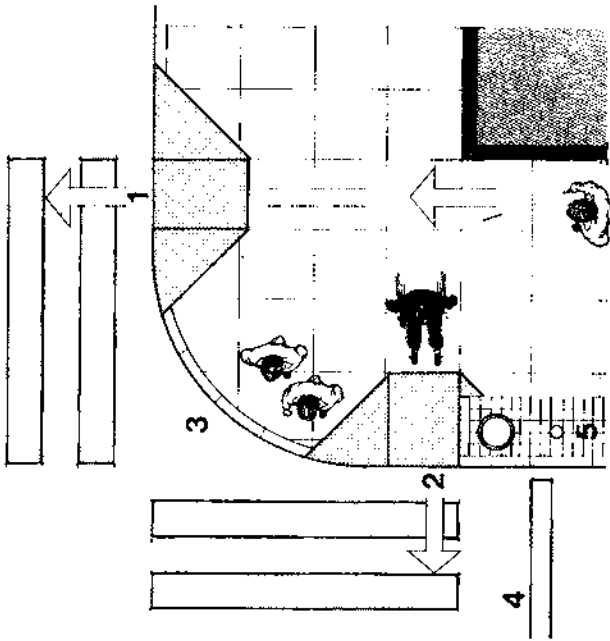
- B 1. Space required for wheelchair to stop and turn — potential accident point.
2. Landscaped or textured strip ending at right angles to the pedestrian crossing plus the straight curb edge provide directional cues for blind persons using crossing.
3. Straight curb edge at right angles to the crossing provides the blind with a good directional cue.

**Type A. Curb ramp placed so that it bisects corner**  
 Ideal use for broad and heavily pedestrian trafficked sidewalks. Requires wide pedestrian crossings. Curb ramp must not be placed randomly in corner.

**Figure 3.3.4**  
**Acceptable Curb Ramps**

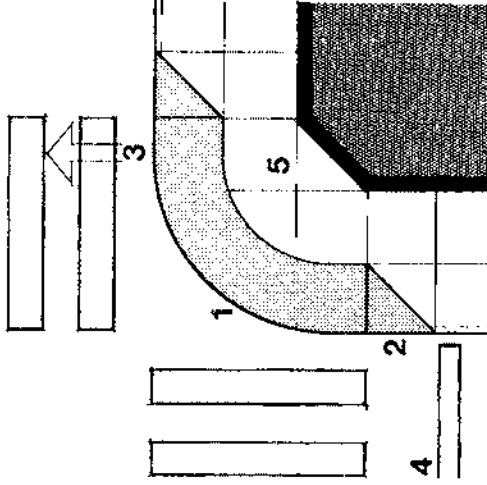


**Figure 3.3.4A-1**  
**Curb ramps**



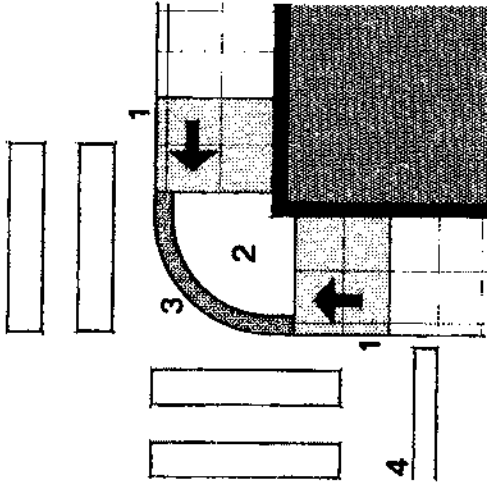
1. Curb ramp must be located inside the pedestrian crosswalk when curb ramp is located in the direct line of travel of a blind person using the building face as a location cue. The curb ramp surface shall have a texture change from the sidewalk surface.
2. Landscaped or textured strip makes curb ramp flare unnecessary. Also provides orientation cue for the blind.
3. Provide sufficient space between curb ramp flares so that pedestrians are not faced with an undulating surface.
4. Stop line for vehicles before crosswalk.
5. Site furniture can be located safely in edge strip.

**Type B. Curb-ramps leading directly into each pedestrian crossing**



1. Must be definite color and texture change on curb ramp to provide visually impaired with location cue. Gently rolled gutter will also provide a cue.
2. Place ramp flare outside the crosswalk.
3. Construct part of the ramp at right angles to crosswalk to provide blind with a directional cue. Gently rolled gutter will help.
4. Stop line for vehicles before crosswalk.
5. Must be at least 3'-0" 915 wide level sidewalk around corner.

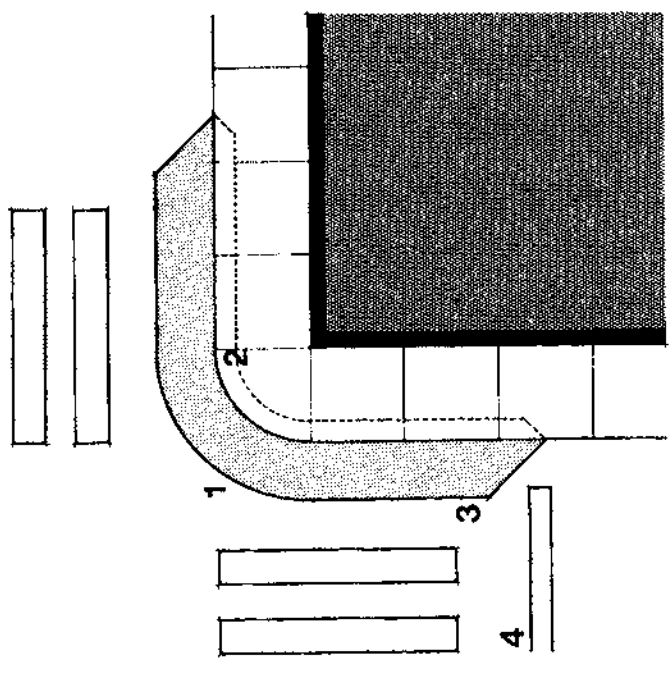
**Type C continuous wraparound curb ramp.**



1. Whole width of sidewalk ramped down to corner 1:12 maximum slope. More gradual slope preferred. Slope shall have texture and color change to rest of sidewalk.
2. Depressed quadrant may slope 1:50 to gutter.
3. Corner must have texture and color change to rest of sidewalk, and preferably be accompanied by a gently rolled gutter.
4. Stop line for vehicles before crosswalk.

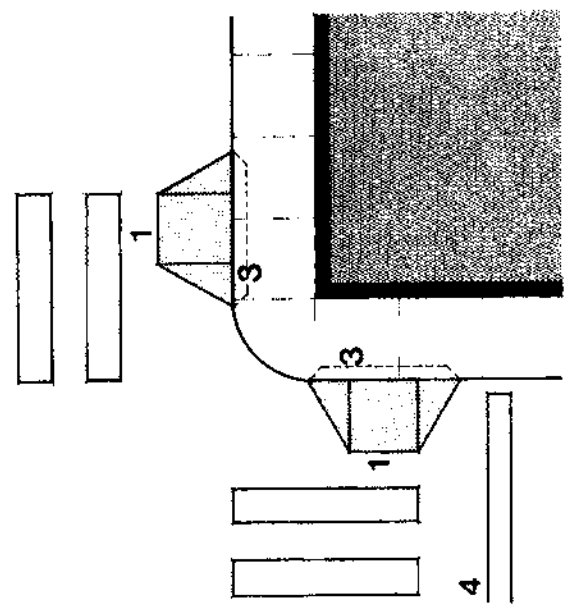
**Type D ramped sidewalks and depressed corner**

**Figure 3.3.4**



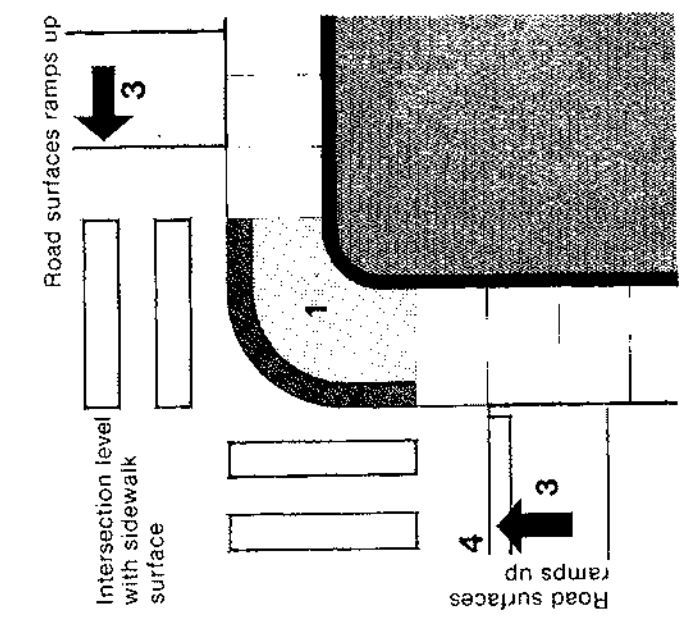
1. Ramp must have a definite color and texture contrast to the rest of the surfaces. Projecting ramp can take the advantage of the slope of the street surface. See Figure 3.3.4 FF. It may interfere with snowplows. Vehicles moving over it may distort or break up the surface.
2. Ramp can be partially recessed providing sufficient level sidewalk remains for wheelchair movement—at least 3'-0". See Figure 3.3.4 FF.
3. Continue projecting ramp beyond crosswalk before creating the flare.
4. Stop line for vehicles before crosswalk.

**Type G projecting wraparound curb ramp**



1. Ramp must have a definite color and texture contrast to rest of the surfaces. Projecting ramp can take advantage of the slope of street surface. See Figure 3.3.4 FF. They may interfere with snowplows. Vehicles moving over them may distort or break-up the surface.
2. Curb ramp flares may be a hazard to persons crossing the road if the curb is high.
3. Ramp can be partially recessed, providing sufficient level sidewalk surface remains for wheelchair movement—at least 3'-0". See Figure 3.3.4 FF.
4. Stop line for vehicles before crosswalk.

**Type F paired projecting curb ramps**



- A 1. Must have a definite color and texture contrast to the sidewalk and road surfaces and extend to the edge of the crosswalk markings.
2. Additional textured strip to aid blind in orienting himself with crosswalk.
3. Ramp road surface can only be used on streets with slow moving traffic.
4. Stop line for vehicles before crosswalk.

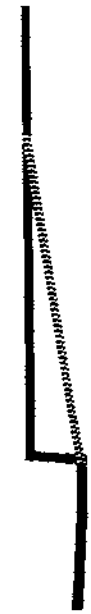
**Type E raised intersection**



Whole of curb ramp projecting from sidewalk



Curb ramp partially recessed in sidewalk

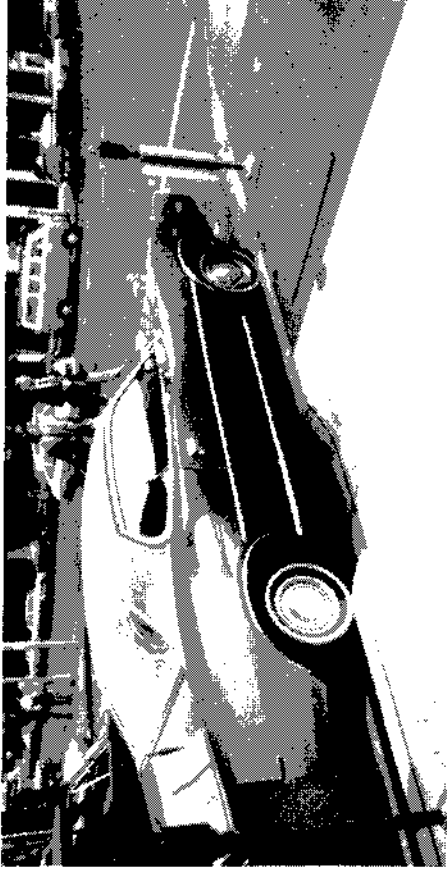


Whole of curb ramp recessed in sidewalk

**Figure 3.3.4 FF**



Some materials used in the construction of curb ramps become slippery when wet. Jointed materials may create tripping hazards and jolting over the joints may cause spasticity in a person using a wheelchair.



This car is legally parked, but denies the use of the curb ramp. The ramp should be placed in the crosswalk.

Photo: John A. Templer



The curb ramp is arbitrarily placed in the corner which could confuse and disorient the blind pedestrian.

Photo: John A. Templer

### 3.3.5

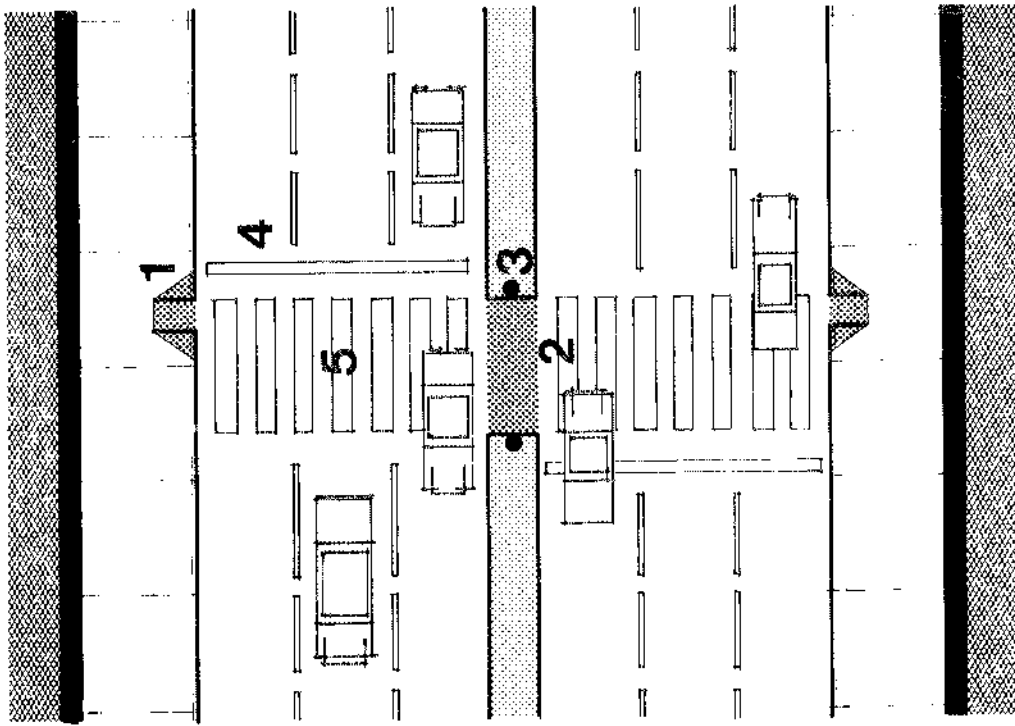
The surfaces of curb ramps shall be joint free and slip-resistant. See Section 13.1, Ground and Floor Surfaces.

Traffic signal times are usually based on the walking speed of the 50 percentile. Thus, there is insufficient time for half the population to cross the road conveniently and safely.

### 3.4

#### STREET CROSSINGS

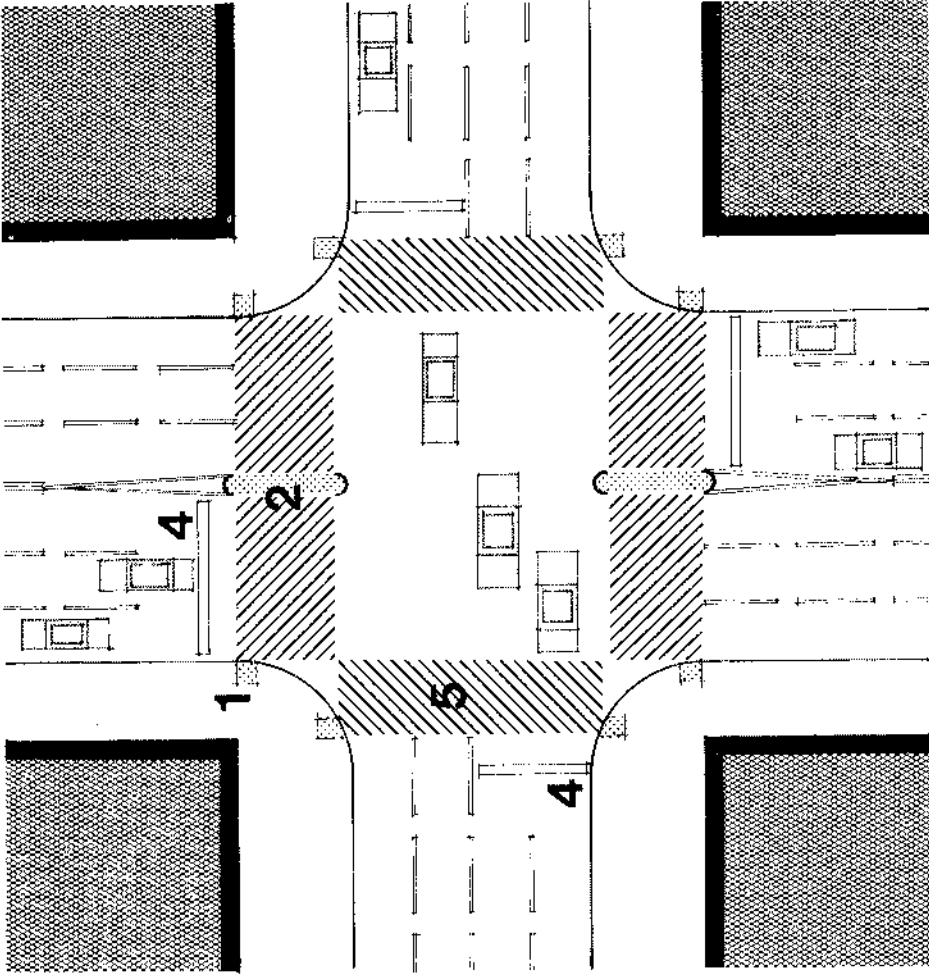
Intersections of walks with streets shall minimize conflicts between pedestrians and vehicles.



Island occurring in crosswalk at mid-block

1. Curb ramp
2. Island at same level as crosswalk. Island must have a texture and color contrast to crosswalk surface.
3. Provide pole or rail support at island for aid to people with balance and agility problems.
4. Marked crosswalk.
5. Stop line for vehicles before crosswalk.

Figure 3.4  
Street crossings



Island occurring in crosswalks at signalized intersection

Photo: Michael A. Jones



An example of a raised pedestrian crossing.

For some of the elderly and semi-ambulatory, high curbs are impossible to negotiate. Many people can negotiate high curbs only if they use street furniture to help them.

The lack of uniform curb heights from one side of the street to the other sometimes causes pedestrians to trip.

It is difficult for a blind person to cross a road when the traffic sounds are obscured by other noises such as wind, rain, construction noises, elevated railways, etc.

It is difficult, frightening, and sometimes impossible for many pedestrians to cross a road where vehicles are permitted to turn on the red traffic light as the walk cycle begins. This is particularly hazardous for blind people.



The traffic island is inaccessible to those in wheelchairs and to some of those with gait problems.

Photo: John A. Templer

Traffic islands often have curbs, making them difficult or impossible for anyone other than the fully ambulatory to cross.

On narrow traffic islands, waiting can be frightening because of insecurity caused by the proximity of moving vehicles. Wheelchairs project into the traffic flow on narrow islands.

Where there is no audible signal indicating the changes of traffic lights, the blind have difficulty knowing when to cross the road.

Street crossings shall be considered as continuations of walks and sidewalks and meet the requirement of Section 3.2, Walks, Sidewalks and Section 3.3, Curb Ramps.

### 3.4.1

Where street crossings intersect with islands, the surface of the islands shall blend to a common level with the crossing surface. The surface of the crosswalk at the island shall have a different texture and color to give indication to the visually impaired. See Section 12.3, Tactile Floor Surface Alerts.

### 3.4.2

Islands shall be a minimum of 4'-0" wide to prevent people in wheelchairs from protruding into the flow of vehicular traffic when waiting to continue crossing. A support device shall be provided to steady people with balance problems while they wait for vehicles to stop moving. The support device may be a guardrail or pole.

### 3.4.3

Pedestrian overpasses and underpasses shall be accessible paths of travel and meet the applicable requirements of this Standard, and follow the requirements of Section 6.1, Ramps and Section 3.2, Walks, Sidewalks.

### 3.4.4

Example of an accessible island.

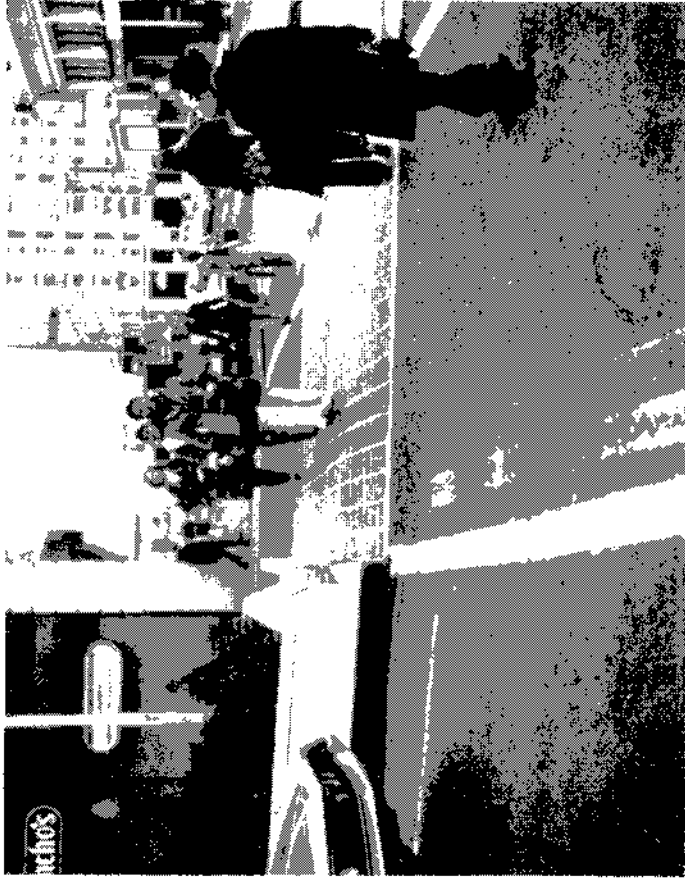


Photo: John A. Templier

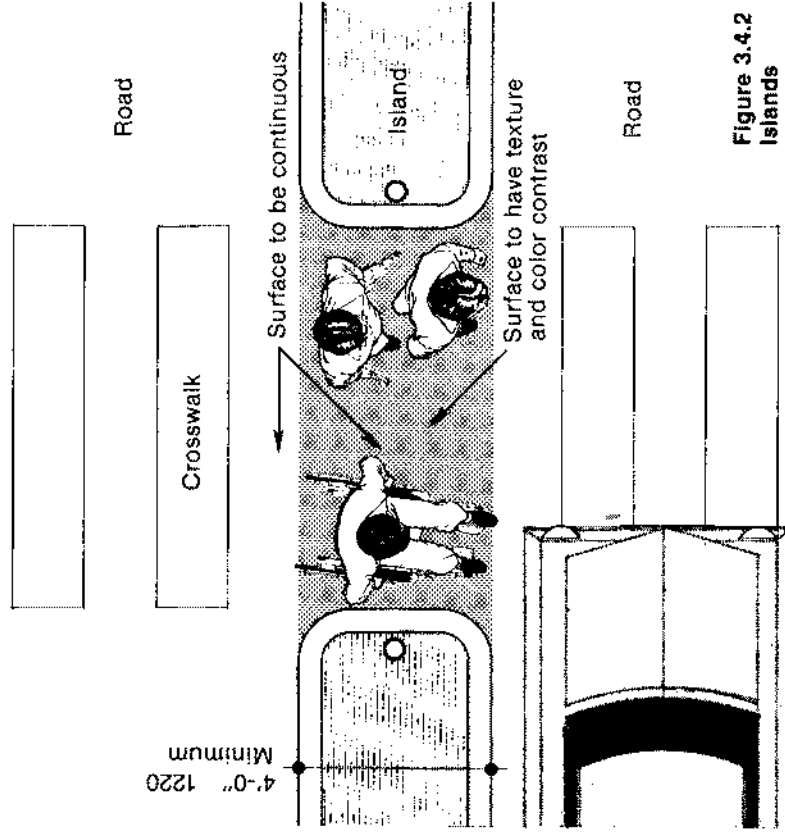


Figure 3.4.2 Islands



Photo: Michael A. Jones

Example of ramped sidewalks and a depressed corner. The gently rolled gutter provides a blind location cue.



Accessible pedestrian overpass.

Photo: James Chiampas

Where automatic traffic signals are provided, the minimum time for holding a red light or pedestrian interval should be determined by the time needed for crossing the street at a maximum speed of 1.5 feet/second, plus a tolerance of 2 seconds for reaction and response time. A 2 second all red interval should be provided between cycles to provide additional safety for the visually impaired.

Parking spaces reserved for the handicapped in commercial zones are seldom provided.

Many disabled people have stamina limitations. Parking spaces are often too far away from the destination, thus excessive and exhausting distances have to be travelled.

Where there is no clearly defined pedestrian circulation path through a parking lot, it is difficult or dangerous for a visually impaired person to walk safely. This is particularly true of parking lots surrounding shopping centers.

At times pedestrians have to walk where vehicles have been parked, and oil on the surface may create a slippery condition.

### 3.5

#### PARKING

Parking for the disabled driver accommodates persons unable to use public transportation, but who can achieve independence by driving their own automobiles.

#### 3.5.1

Parking facilities include interior and exterior parking spaces, parking lots, and passenger loading zones.

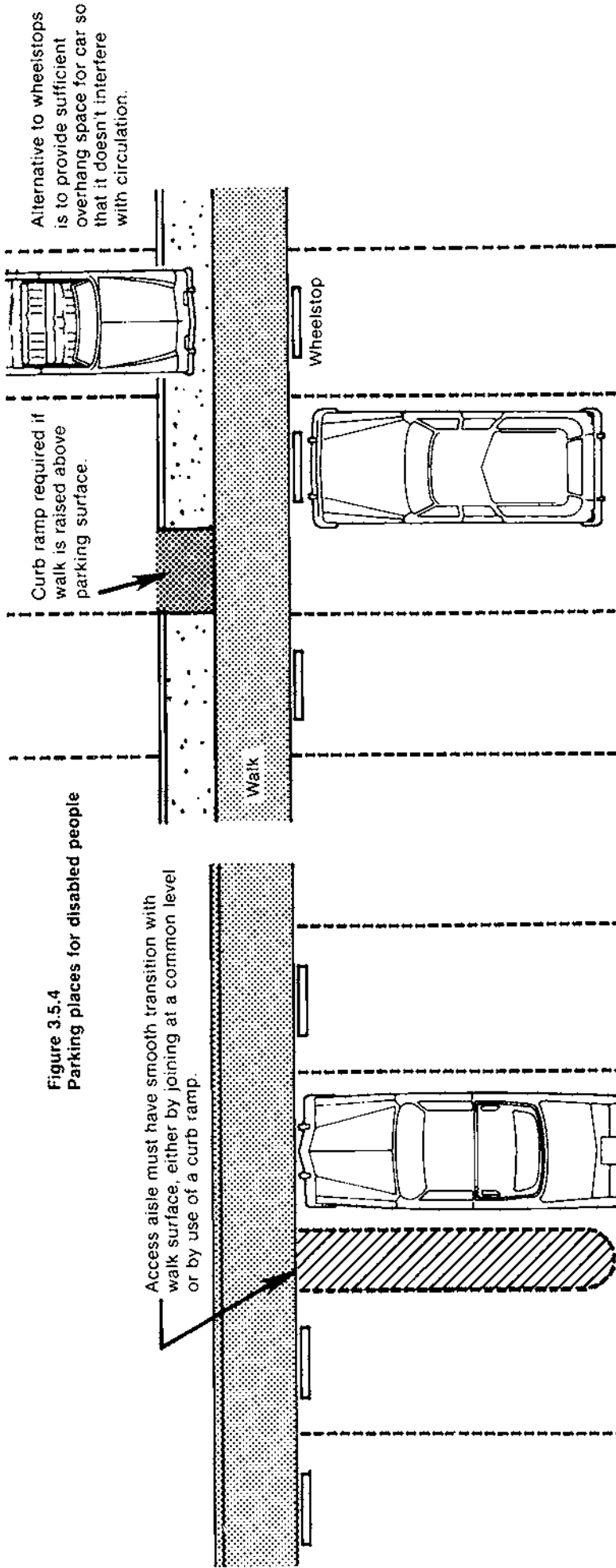
#### 3.5.2

When parking areas are provided, they shall have handicapped parking spaces or a passenger loading zone located as close as possible to the shortest accessible path of travel to each building, adjacent street or sidewalk served by that parking area. If walks are provided through the parking area, they shall follow the requirements of Section 3.2, Walks, Sidewalks.

#### 3.5.3

Passenger loading zones shall provide an unobstructed space at least 4'-6" wide, parallel to the vehicle to allow unloading and loading of passengers. There shall be no abrupt change of level between the passenger loading zone and the road. There shall be a change of surface texture and color to indicate the boundary of the space used by pedestrians. See Section 12.3, Tactile Floor Surface Alerts.

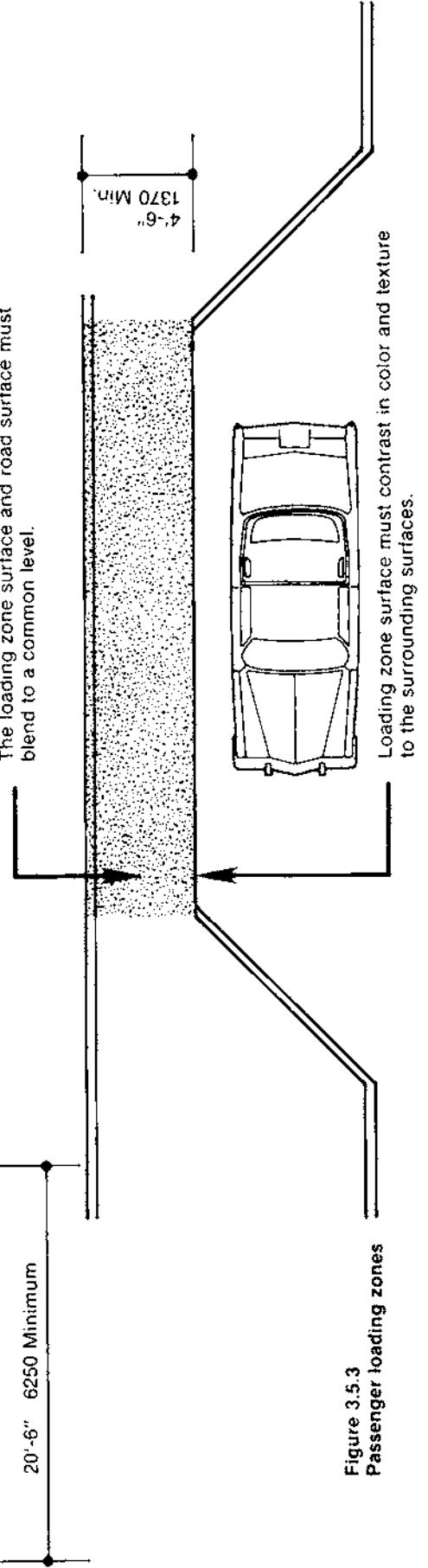
**Figure 3.5.4**  
**Parking places for disabled people**



If vehicle can enter parking space by going in forward only, then one access aisle shall be provided for each disabled person's parking space.

If vehicle can enter parking space by going in forward or in reverse, one access aisle will serve two parking spaces.

The loading zone surface and road surface must blend to a common level.



**Figure 3.5.3**  
**Passenger loading zones**

Where wider parking spaces are not provided for handicapped drivers, they experience several problems. There is not enough space to get a wheelchair out of the car in a conventionally sized parking space. If the disabled person's car has been "boxed in" by other vehicles, he has to wait for the other owners to return to their cars before he has space to get into his. Persons with crutches also face this problem.

Where parking spaces slope too much, it is difficult or impossible for a person to transfer from his chair to the car or vice versa, because the chair may roll or slide. This situation is also difficult for those who use crutches.

**3.5.4**

Parking spaces specifically reserved for people who use wheelchairs or walking aids shall be at least 12'-6" wide. Where two adjacent spaces are planned, and entry can be gained by the car going in forward or in reverse, the width of both spaces plus access aisle shall be a minimum of 20'-6" with the access aisle located between the two spaces. If entry can only be gained by going in forward, each space reserved for a disabled driver shall have an access aisle. The access aisles shall be at least 4'-6" wide and preferably be level, but may have a slope for drainage not exceeding 1:50. The surface shall be firm. See Figure 3.5.4.

**3.5.5**

The number of parking spaces planned for disabled drivers in parking lots shall be as shown in Table 3.5.5.

**Table 3.5.5**

Total Number of Parking Spaces	Number of Disabled Drivers
1-400	A minimum number of 2 or 2% of the total provided, whichever is the greatest
401 and above	8 plus 1% of the total provided above 401

**3.5.6**

In parking structures, a minimum headroom of 8'-0" shall be provided for circulation and parking of vans used by disabled persons. The number of spaces to be provided with this clearance shall be half of the number of handicapped parking places computed from Table 3.5.5. The access aisle shall be 6'-0" wide, though it may extend into the vehicular circulation route when parallel parking is provided. See Figure 3.5.6.

**3.5.7**

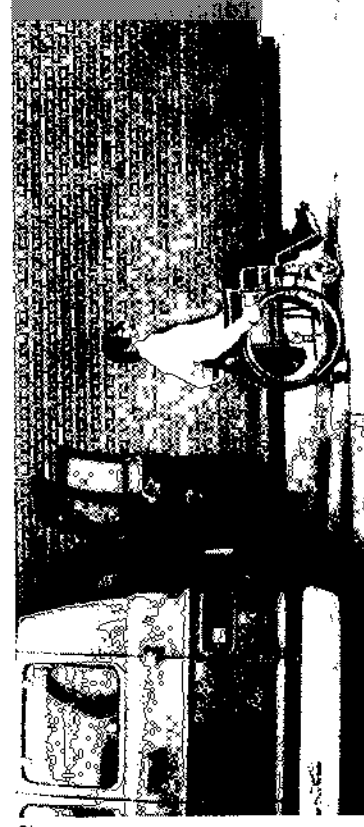
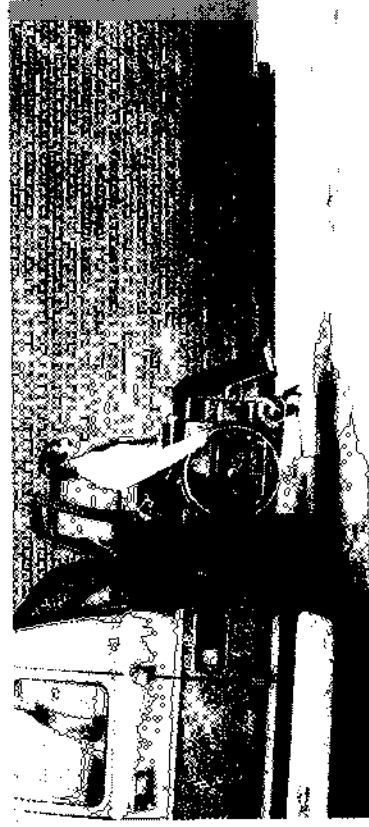
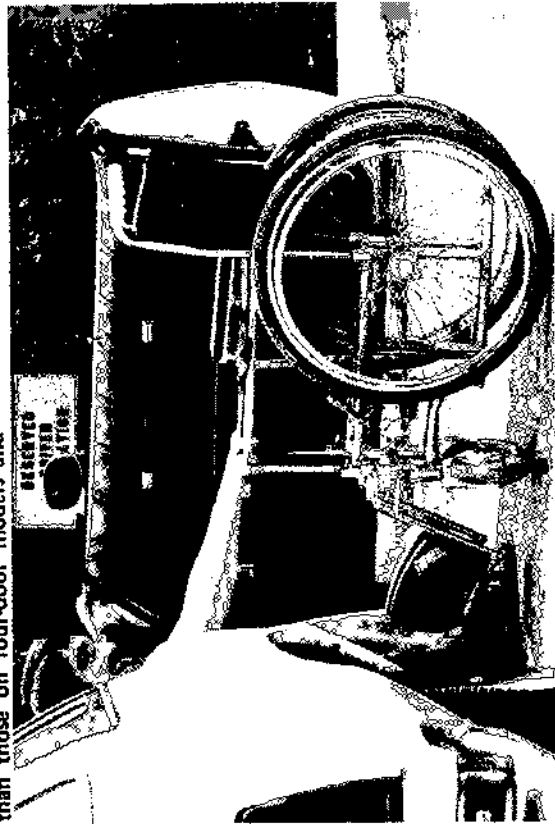
There are often barriers, such as curbs with no curb ramps, between parking places and destinations.

Multi-story parking structures without elevators shall have all spaces reserved for disabled drivers on an accessible floor.

**3.5.8**

Where curbs are required around the parking area, curb ramps shall be provided to the accessible route of travel, and shall conform to the requirements of Section 3.3, Curb Ramps.

Most disabled drivers use a two-door sedan. These doors are much wider than those on four-door models and thus extra space is required to permit the person to transfer safely.



A person using a van equipped with a lift requires extra space because the chair has to leave the lift platform before any turns can be made.

FIGURE 3.5.6 A 6'-0" wide space is required at the side of a van equipped with a lift.



The sequence of a person leaving his car and transferring into his wheelchair. As he is paralyzed, he has to lift each leg with his hand, and support his body weight with his arms as he transfers from the car into his wheelchair.



Parking spaces reserved for the handicapped are often used by the able-bodied driver.

### 3.5.9

Parking spaces for the disabled shall be marked to indicate that they are reserved for disabled drivers, using the International Symbol for Accessibility. Such markings shall be placed on a pole or wall mounted and may be accompanied by markings painted on the surface. See Figure 3.5.9.

Children, small persons, and those in wheelchairs, may not be seen as they move from behind or between parallel parked cars when crossing the road, or when travelling down traffic lanes in parking lots. Similarly, a blind person's seeing-eye dog may not be noticed by a passing motorist.

### 3.5.10

Where pedestrian walks cross vehicular routes, the intersection shall be clearly marked so that drivers shall be warned of the pedestrian crossing.

### 3.5.11

The requirements of Sections 3.5.4, 3.5.5, 3.5.7, 3.5.8 and 3.5.9 can be waived if attendant parking is provided at all times.

## 3.6

### PEDESTRIAN GATES AND TURNSTILES

#### 3.6.1

Gates shall meet all the requirements of Section 4.1 Entrances and Section 4.2 Door Hardware.

#### 3.6.2

Where turnstiles are provided, an accessible entrance shall be placed immediately to one side of the turnstile. This entrance shall meet the requirements of Section 4.1, Entrances, and Section 4.2, Door Hardware.

## 3.7

### SITE FURNITURE

Site furniture includes, but is not limited to, the following permanent construction: signs, lighting standards, mailboxes, trash cans, seating, planters, tables, advertising kiosks, newspaper boxes, telephone enclosures, etc. Their location shall allow free passage and full, non-hazardous use of site amenities.



Gates are often too narrow for those in wheelchairs, difficult for those with babes-in-arms, parcels, etc., or who may have difficulty putting a ticket into a slot to open the barrier.

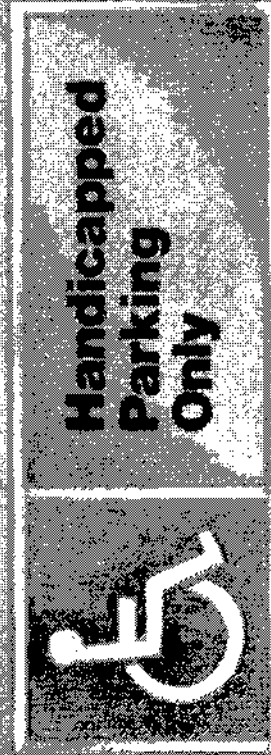
Photo: Michael A. Jones



Planting strip also allows street furniture to be located outside of the pedestrian circulation path.

Photo: John A. Templer

Figure 3.5.9  
Examples of handicapped parking signs



Devices, such as telephone booths, signs and traffic control boxes, which are supported on poles or pylons may project into pedestrian circulation routes and be hazardous to blind and sighted persons alike. The blind can locate the pole with their cane, but might be unprepared for the projection that occurs at chest or head height.



**Traffic light control boxes are often located at head-height which is above the detectable range of the white cane.**

Projecting signs that occur at head height are hazardous to all pedestrians and extremely dangerous to those who are blind and visually impaired.

Guy wires, posts and projections from walls frequently obstruct pedestrians. They may not be located by the blind using a cane.



Photo: Michael A. Jones



**Poles located in sidewalks interfere with pedestrian movement, especially when bicycles are chained to them.**

**Rarely is shelter provided at rest areas for protection in hot or inclement weather.**

Photo: Mayor's Office for Senior Citizens and the Handicapped, Chicago

An adequate number of resting places along sidewalks or walkways are not provided.

Elderly or disabled persons with little stamina have to rest frequently. Some pedestrians have to rest after walking less than one minute. Many people stop to rest after one to five minutes of walking or wheeling. Sheltered rest areas are seldom provided for inclement weather.

### 3.7.1

If any furniture is mounted on a post or pylon and projects more than 4" into the nondetectable area of blind people who use long canes, then the projection shall:

- a. continue to the floor, or
- b. to within 8" of the floor surface, or
- c. be located in protected areas which are recessed or enclosed by wing walls. Such an area shall have a contrasting floor texture and color.

### 3.7.2

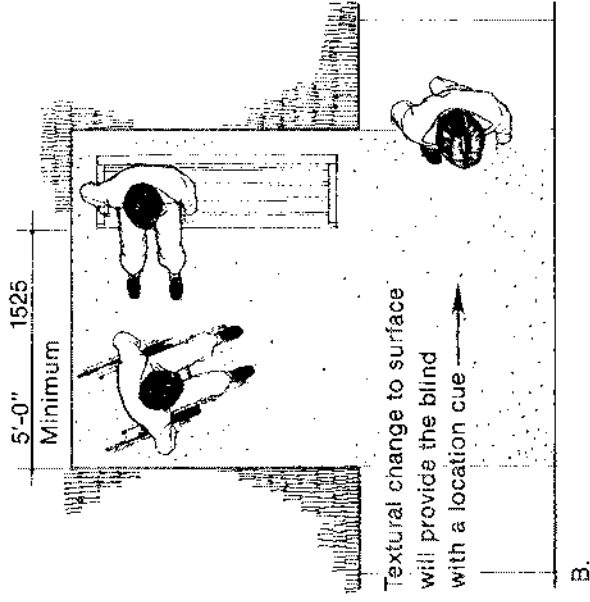
Signs shall not project into the space above a walk unless the dimension from the bottom edge of the sign to the walk surface is at least 7'-6".

### 3.7.3

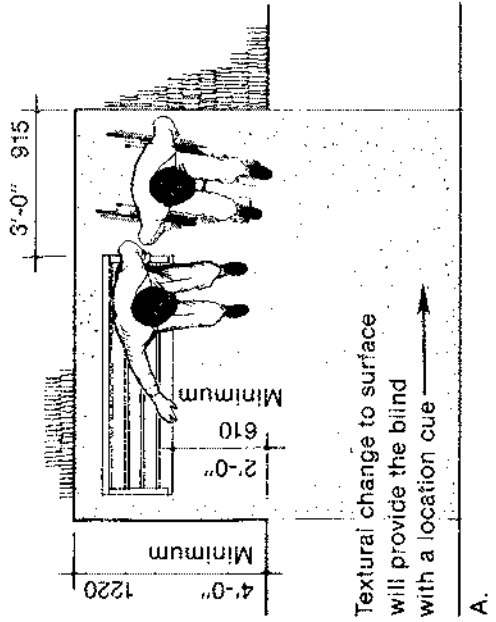
Guy wires required for poles or pylons shall be placed outside of pedestrian circulation areas.

### 3.7.4

Where rest areas are provided, space shall be included alongside the seating to accommodate those in wheelchairs. This space shall be a minimum of 3'-0" wide and extend a minimum of 4'-0" from the pedestrian flow. See Figure 3.7.4.



B.



A.

**Figure 3.7.4**  
**Space requirements for wheelchairs adjacent seating**

Photo: John A. Templer



Good example of rest area located near the corner, out of the circulation path, but close enough to be 'policed' by passers-by.

Where benches are provided outside the pedestrian walk, there is seldom adequate space for a person in a wheelchair to rest.

### 3.7.5

Seating shall be constructed to support a minimum of 250 lbf. for each person accommodated, and be provided with back and armrests. Seating shall not hold water.

It is difficult for people with bending, balance or stamina problems to sit or rise from benches which do not have arm rests provided. They are a mobility aid for some people when carrying out these tasks.

Exterior benches are often designed so that water fails to drain adequately from the seat. Benches are often uncomfortable.

Landscaping, street furniture, or articulated building facades can provide hiding places for muggers and purse snatchers. Some rest areas are located so they cannot be readily policed by passers-by.



**Seating that is poorly located will seldom be used.**

Photo: Michael A. Jones

People in wheelchairs may be unable to draw up close to picnic tables, because the table top is too low. Fixed seating can also prevent wheelchair access.

### 3.7.6

Where tables are provided, they shall be designed to accommodate a wheelchair. There shall be clear space of 2'-6" minimum from the ground to the underside of the table. There shall be toe clearance underneath the table of 2'-0" deep, and the space shall be at least 2'-6" wide. See Figure 3.7.6.

Some grocery stores have barriers to prevent shopping carts from being stolen. However, these barriers also prevent wheelchair access to the store, and inadvertently discriminate against the disabled shopper.

### 3.7.7

Furniture that will be used by disabled persons shall be located on firm, smooth surfaces of sufficient area to enable maneuvering of wheelchairs. See Section 2.3.2.

Any device used by shops and stores to prevent shopping carts from leaving the premises shall not prevent access to such shops and stores for those in wheelchairs. Entry shall be equally convenient for the disabled and the able-bodied population. See Section 4.1, Entrances, and Section 4.2, Hardware.

### 3.7.8

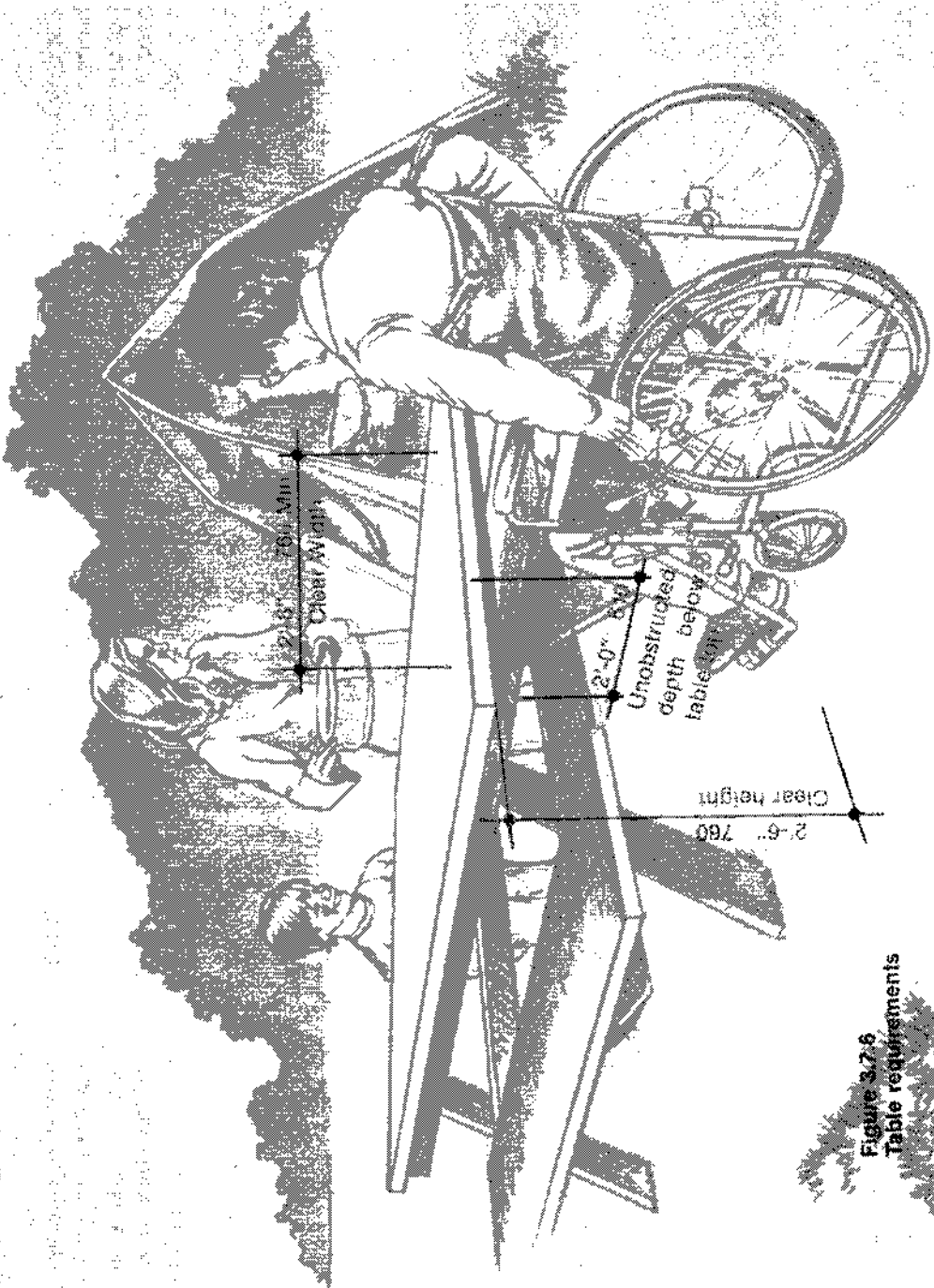


Figure 3.2.6  
Table requirements

### LOCATABLE BARRIERS

Reflecting pools, planting areas and other landscape features occurring in or adjacent to walkways shall have locatable barriers of not less than 6" high. Tree grilles shall meet the requirements of Section 3.2.7. Gratings and Manhole Covers.

### 3.8

#### 3.8.1

Small raised curbs around planting areas, reflecting pools, etc., can be dangerous for those with vision impairment, especially if they do not use the long cane technique or a seeing eye dog. Even fully sighted people can trip over very small curbs because they are visually insignificant.

Raised or sunken planting areas and planters, advertising kiosks, benches, newspaper boxes, etc., are frequently located without thought to the pedestrian circulation patterns, creating hazards for the blind and sighted person alike.

Moveable street furniture, such as newspaper boxes, are hazardous for blind persons who memorize their routes and use them regularly.



**A rope barrier is difficult to see in normal conditions but becomes almost invisible in bad conditions. The traditional sawhorse is unacceptable unless it has a lower rail which can be detected by the blind.**

It is dangerous for all people if the sidewalk or walkway crosses a ditch or gully and does not have the protection of a wall, parapet or railing, but it is especially so if a person's mobility is impaired.

#### 3.8.2

Where walks and sidewalks pass alongside or over ditches, embankments or other hazardous areas, guardrails shall be located on both sides of the walk and shall meet the requirements of Section 6.3. Handrails and Guardrails.

Chains and ropes are hazardous to the blind because they may not be located with a cane.

#### 3.8.3

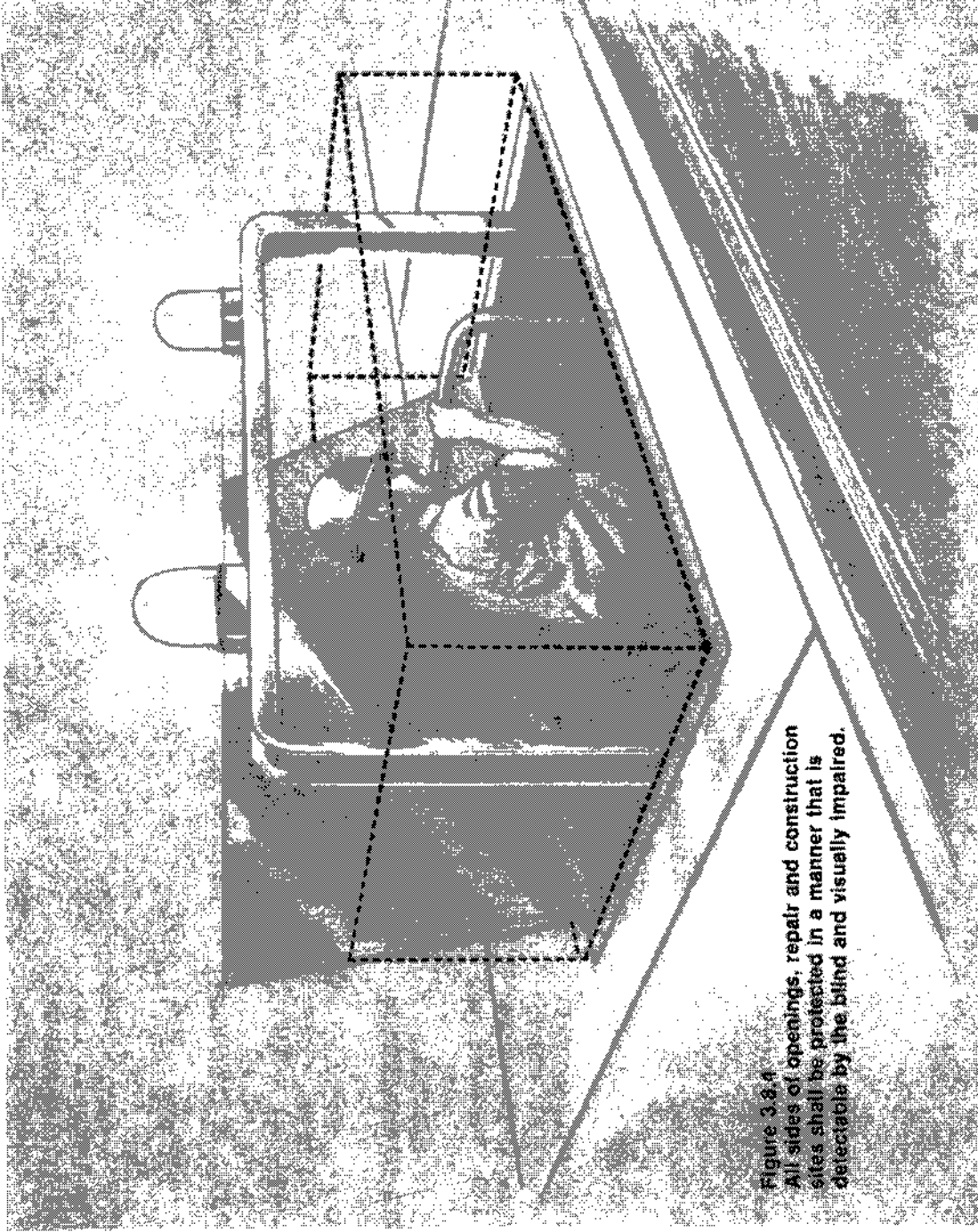
Chains, cables or ropes are not acceptable as permanent or temporary exterior barriers unless they are provided within the locatable range of the long cane technique. See Section 2.8.1.

Repair sites in sidewalks are often inadequately protected. Visually impaired persons may be exposed to danger if the protective barrier cannot be located with a cane.

#### 3.8.4

Where temporary barriers are required, the barrier shall be designed to be locatable with the long cane technique and shall protect all sides of the work, opening, or excavation. Visible warnings shall be provided at night.





**Figure 3.8.4**  
All sides of openings, repair and construction sites shall be protected in a manner that is detectable by the blind and visually impaired.



**3.8.5**

Where temporary walks are provided around building sites or other situations, the temporary walk shall conform to all requirements of Section 3.2, Walks, Sidewalks. All accessible features temporarily closed by any work shall have alternate accessible features readily available.

It may be impossible or difficult for those who are small or have upper limb impairment to take tickets from parking ticket dispensers or to put money into a parking meter. If the parking meter is located too high, a person in a wheelchair might not be able to read the parking charges.

**3.9**

**CONTROLS, DISPENSERS AND RECEPTACLES**

Controls, dispensers and receptacles shall comply with Section 14.1, Location of Controls, Dispensers and Receptacles.

**3.10**

**SELECTION OF BUILDING PRODUCTS AND MATERIALS**

All handrails, guardrails, hardware, electrical and mechanical controls, fixtures, ground surfaces and signage shall comply with the requirements of Section 14, Building Products.

**3.11**

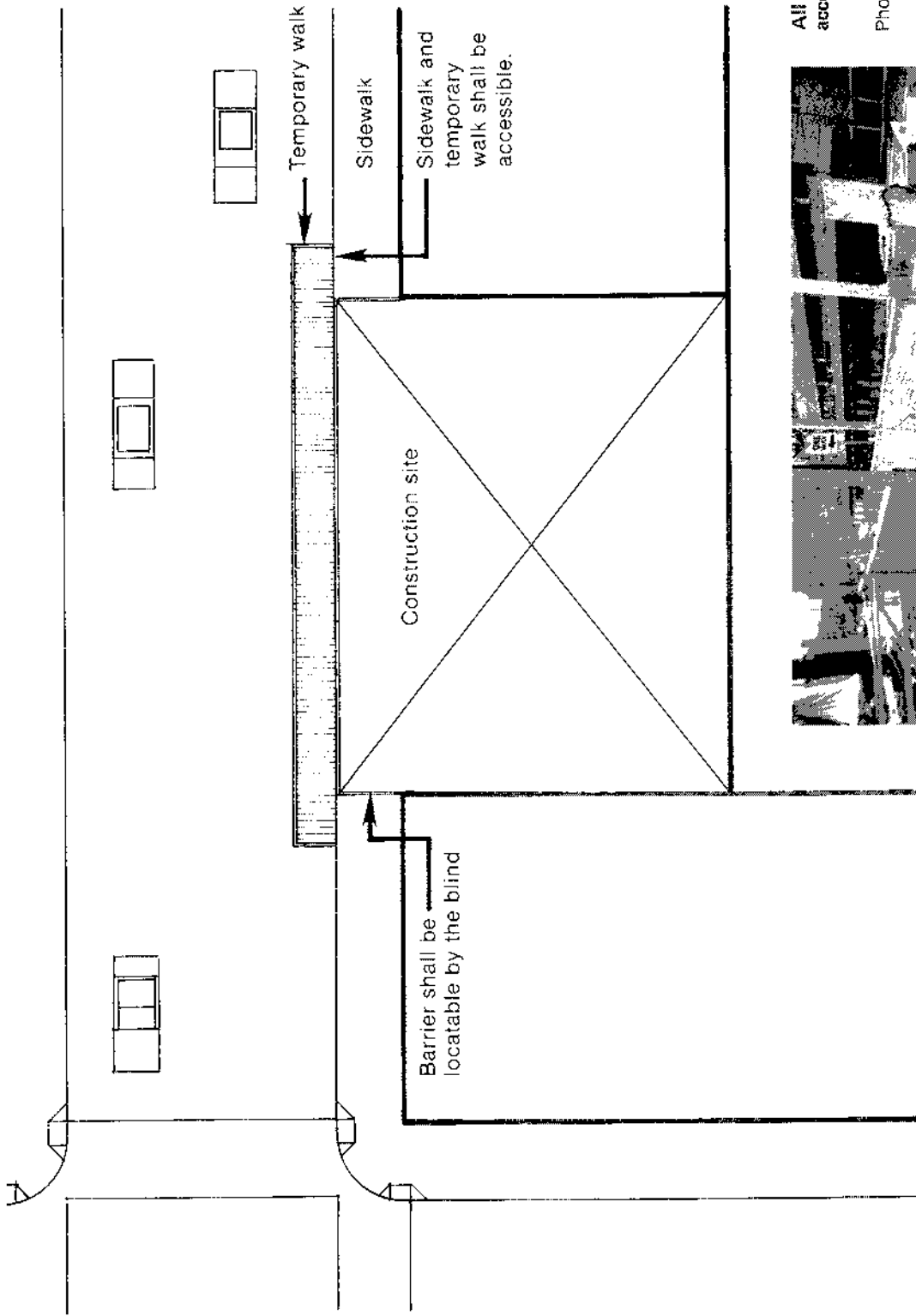
**EXTERIOR STAIRS AND RAMPS**

For requirements of exterior stairs and ramps, see Section 6.1, Ramps and Section 6.2, Stairs.

**3.12**

**EXTERIOR PAY TELEPHONES**

Exterior pay telephones shall comply with the requirements of Section 11.1, Pay Telephones.



All temporary walkways shall be accessible.

Photo: John H. Catlin

Figure 3.8.5 Requirements where temporary walks are required

Remove oak or other stairs legs extending in parking or drive areas, billiard, billiard, or the stairs. They may create a tripping hazard.

Overhanging tree limbs that occur at head height to hazardous or pedestrian and exterior dangers is to those who are blind and visually impaired.



This tree trunk cannot be located by the blind.

Source: Richard A. Jones

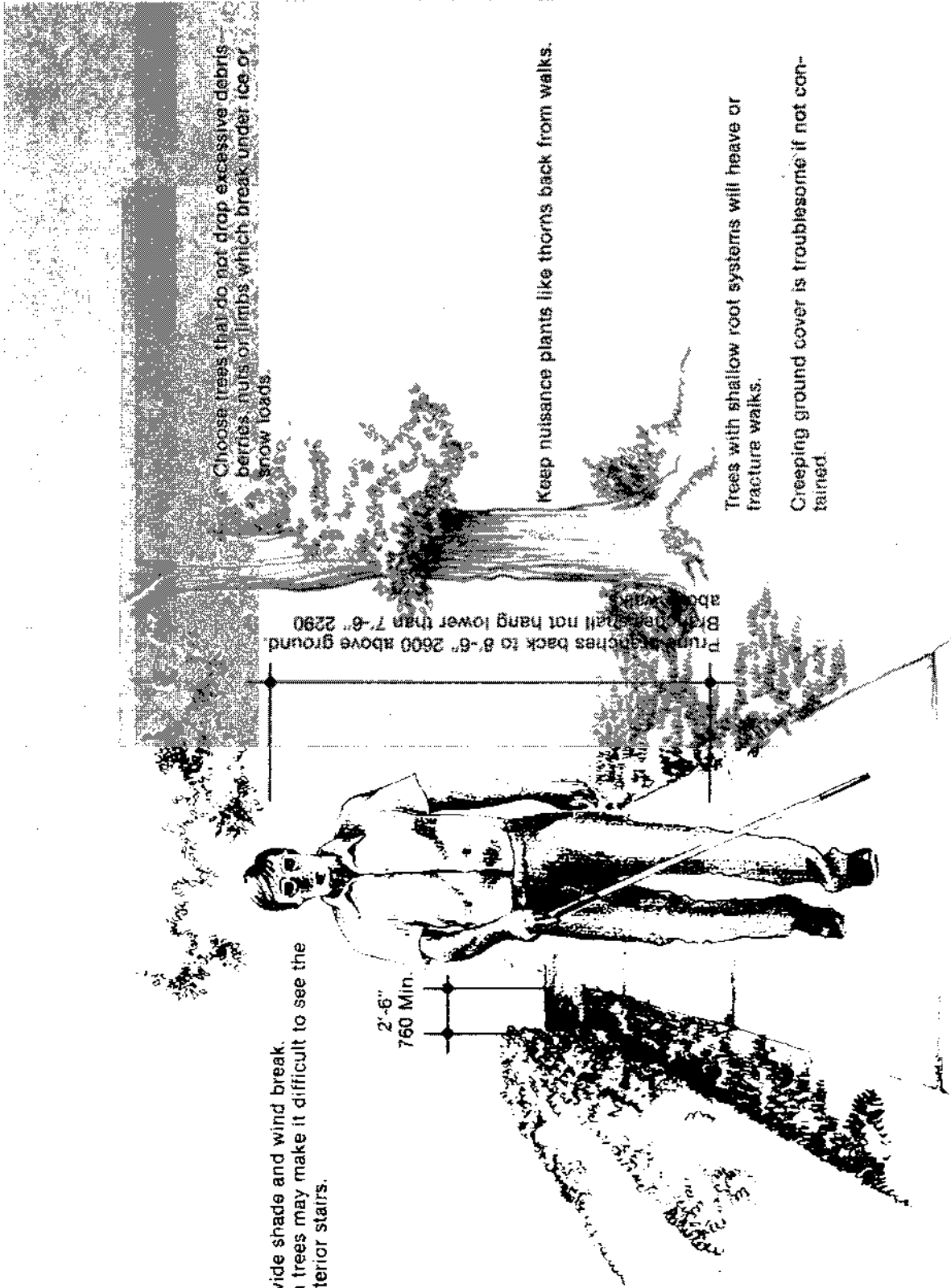
### 3.13

#### 3.13.1

### LANDSCAPING

Landscaping adjacent to walks shall be chosen with consideration to the following criteria:

- a. Thorny plants shall not be used immediately adjacent to walks.
- b. Branches that overhang walks shall be pruned back to the height of 8'-6" above ground and shall hang no lower than 7'-6" above the ground.
- c. Plants that drop large seed pods that could be hazardous under foot shall be placed so that they do not overhang the walk.
- d. Poisonous plants adjacent to walks and rest areas shall be removed.



Trees can provide shade and wind break. Shadows from trees may make it difficult to see the nosings on exterior stairs.

2'-6"  
760 Min.

Trunk branches back to 8'-6" 2600' above ground  
Branches shall not hang lower than 7'-6" 2290'

Choose trees that do not drop excessive debris—berries, nuts or limbs which break under ice or snow loads.

Keep nuisance plants like thorns back from walks.

Trees with shallow root systems will heave or fracture walks.

Creeping ground cover is troublesome if not contained.

Figure 3.13  
Landscaping

## ENTRANCES, DOORS AND DOORWAYS

### 4.1

Where accessible doorways do not occur at main or obvious entrances to a building, disabled people spend more time and energy in trying to locate such accessible entrances.

Often the only accessible entrance for a wheelchair is through the service area of a building. This happens in all types of buildings, from kitchen entrances in restaurants to underground service tunnels in airports.

When only one accessible entrance has been provided in a building, it may be impossible to reach that entrance in the event of a fire or other emergency. The handicapped are denied the same opportunities of escape provided the able-bodied.

If the exterior floor area at an entrance slopes away from the door, a person in a wheelchair may have difficulty as he opens the door, because his wheelchair may roll backwards.

Steps which occur at the door threshold are hazardous for everyone.



A step at the threshold is hazardous for all people but especially for those who use crutches. The door may close on the crutch and trap it.

All major entrances (exits) to buildings and rooms shall be accessible.

### 4.1.1

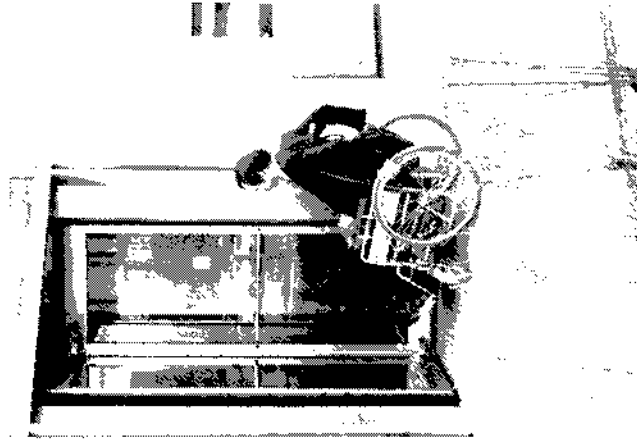
The floor on the inside and outside of each doorway shall preferably be level, but may slope no more than 1:50 for drainage purposes. On the pull side of the door, when location allows forward access only for those in wheelchairs, the floor shall be clear for a distance of 5'-0" from the door and shall extend a minimum of 1'-6" beyond the pull side of the door, measured from the wall opening, unless the doors are automatic. Where side access for those in wheelchairs is possible, the floor shall be clear for a distance of 4'-0" from the door. On the push side of the door, the floor shall be clear for a depth of 3'-6" in residential construction and 4'-0" in all other construction, and be clear at least the full width of the door opening. See Figure 4.1.1.



Persons in wheelchairs cannot use revolving doors. Others having difficulty with them include persons with reduced stamina, agility and reaction time, including the elderly, those who use prostheses, and small children.

Hinged entrance doors, located alongside revolving doors, frequently do not have door pulls on the outside, thus denying access to the building to those who cannot use revolving doors. This is often done to save energy by forcing people to use the revolving doors, which are more efficient than swing doors at retaining the conditioned air inside the building.

Turnstiles are impassable for those in wheelchairs and are very difficult for those who are semi-ambulant, small in stature, or obese.



Revolving doors cannot be used by people in wheelchairs.

Photo: Peter Wachter

Some doors are not wide enough for wheelchairs to pass through. Narrow doors are also difficult for those with crutches and walkers.

#### 4.1.2

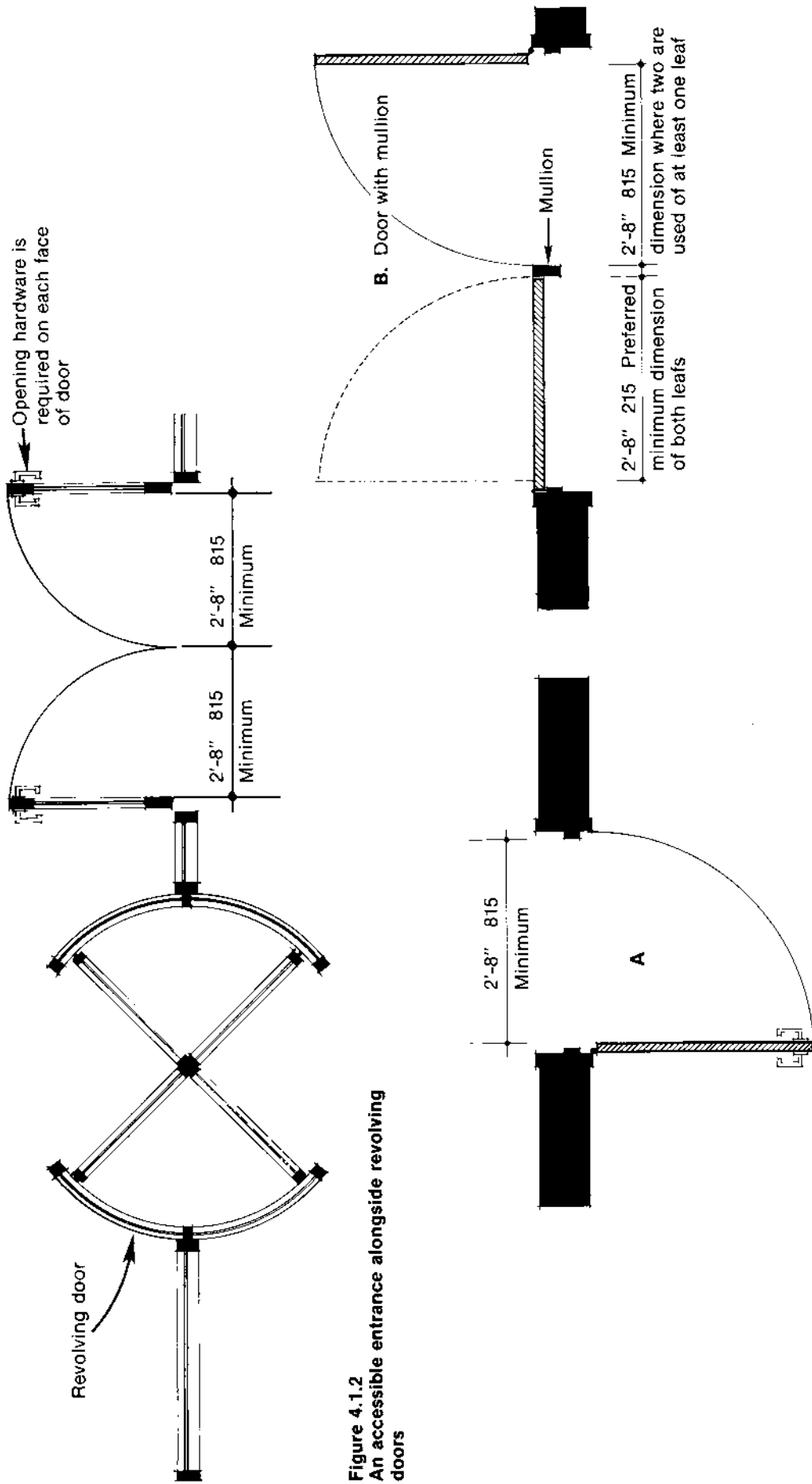
An accessible entrance shall be placed immediately to one side of revolving doors or turnstiles when they are provided. The doors of the accessible entrance shall have opening devices on both faces of the door, and shall not be locked during regular business hours.

#### 4.1.3

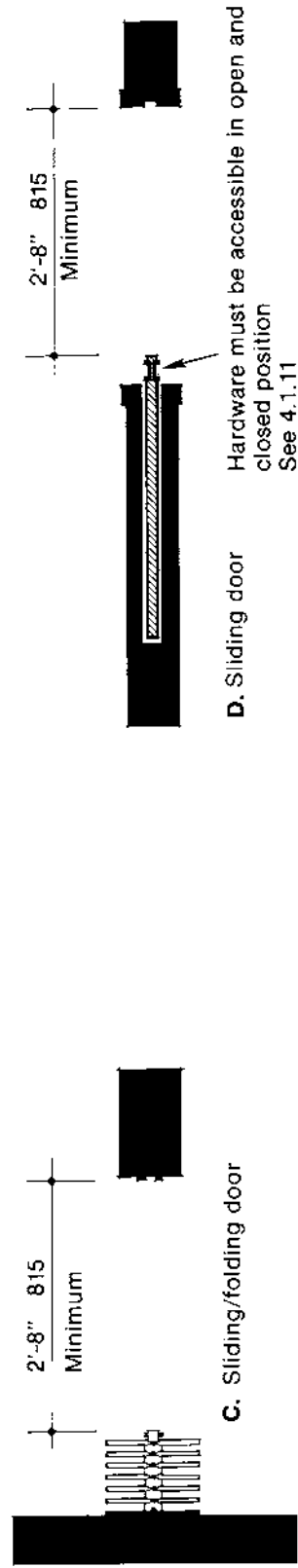
Entrances shall have a minimum clear width of 2'-8". This dimension shall be measured from the face of the door to the face of the door stop, see Figure 4.1.3.

#### 4.1.4

Where more than one door is required at entrances, a left and a right-handed door shall be provided to give disabled persons the choice of door to open which corresponds to their strongest arm.



**Figure 4.1.2**  
An accessible entrance alongside revolving doors



**Figure 4.1.3**  
Minimum clear door openings



Entrance doors in series (draft-lobbies) are often placed too close together so that a person in a wheelchair, or a person with a seeing-eye dog has insufficient space to pass through one door and open the second.

#### **4.1.5**

The minimum space between two hinged doors in a series shall be the width of the door swinging into the space plus 4'-0". Door swings of doors in series shall open in the same direction. Single doors hung in series shall be hinged at the same side, see Figure 4.1.5A.

At vestibules where doors are at right angles to each other, the dimension between the wall with the inswinging door and the facing wall shall be 6'-6" minimum. The minimum dimension in the other direction shall be 5'-0", see Figure 4.1.5B.

#### **4.1.6**

Where double doors are used, at least one leaf shall allow a 2'-8" clear opening. It is preferable that each leaf should allow a minimum clear opening of 2'-8".

Sometimes pedestrians are hit by doors swinging unexpectedly into the circulation space.

#### **4.1.7**

Entrances shall be designed so that doors shall not swing into the path of passing pedestrians, except as provided for by Section 4.1.16.

Often the door mat is an obstruction if it is raised above, or recessed below the floor level. For those with fixed ankle braces, stiff legs, or lower limb prostheses, this situation can cause trips and falls. Such obstacles also obstruct caster-wheels on wheelchairs.

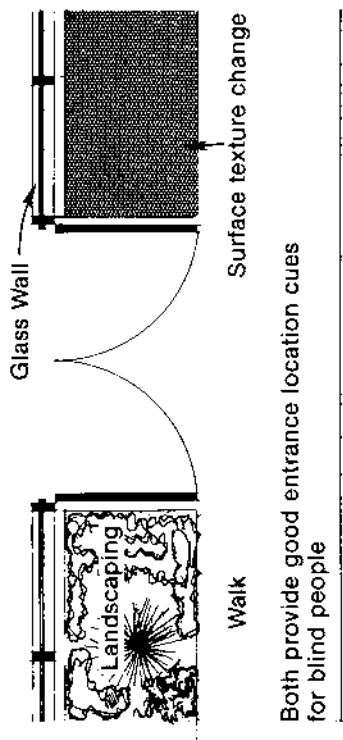
#### **4.1.8**

If door mats are provided at accessible entrances, they shall be firmly secured.

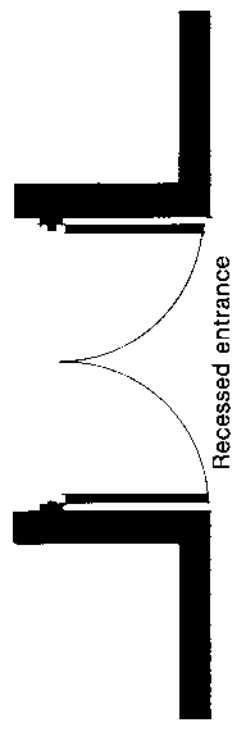
Many openings in floor gratings are too large. Canes and heels can slip between the gratings, and the caster-wheels on wheelchairs can be deflected. Sometimes the space is so large that the wheel drops between the grating. The sudden stop can cause spasticity or cause a person to fall out of his wheelchair.

#### **4.1.9**

Door mats and gratings shall not be barriers. Thick door mats shall be recessed into the surface and shall not project more than ½" above the floor finish. Gratings provided at doors for the removal of snow and sand, etc., shall have a grid opening of no more than ¾" in the narrow direction. The long direction shall run at right angles to the direction of pedestrian travel. The surface of the grating shall be level with the adjacent floor surface. See Figure 4.1.9.



Both provide good entrance location cues for blind people



Examples of protecting passers-by from swing doors

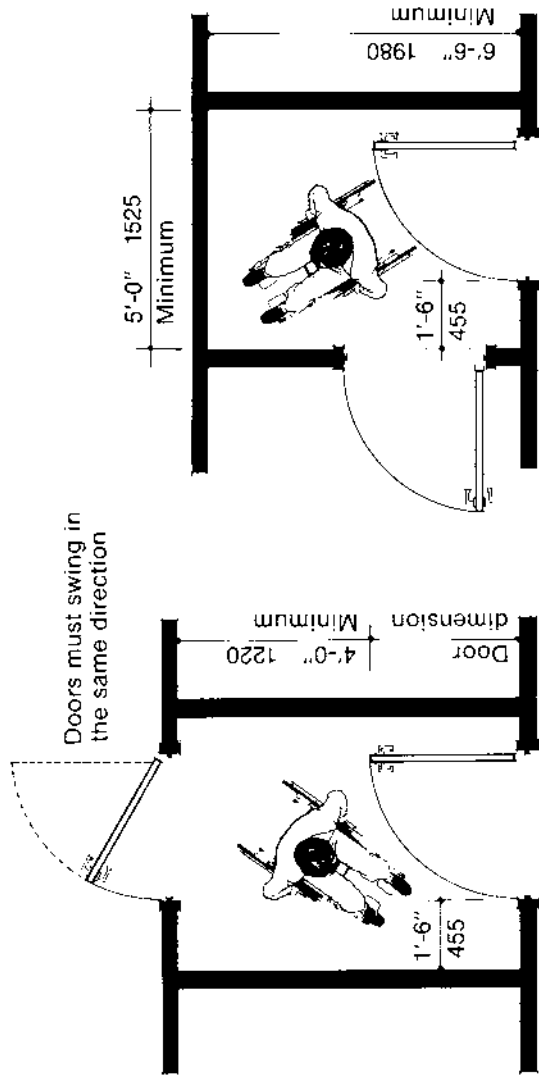


Figure 4.1.5 A  
Minimum requirements for doors opening in series

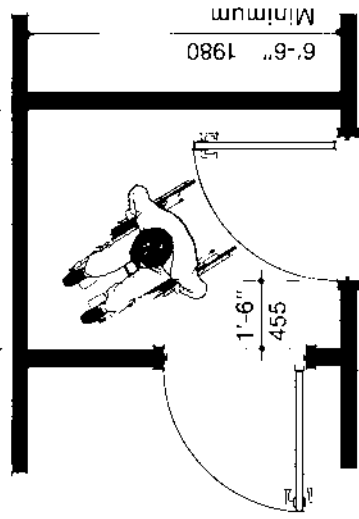


Figure 4.1.5 B  
Minimum vestibule dimensions when doors are located at right angles to each other

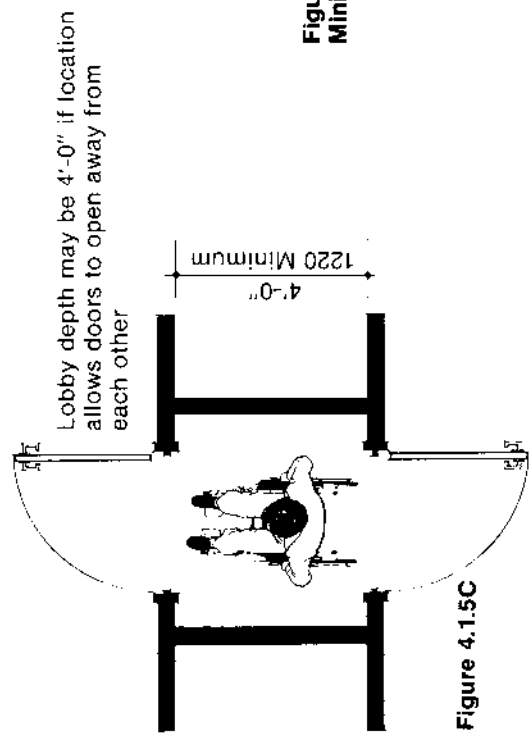


Figure 4.1.5C

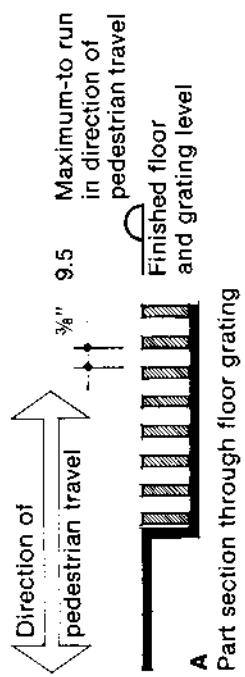


Figure 4.1.9 Requirements for foot cleaning devices at entrances

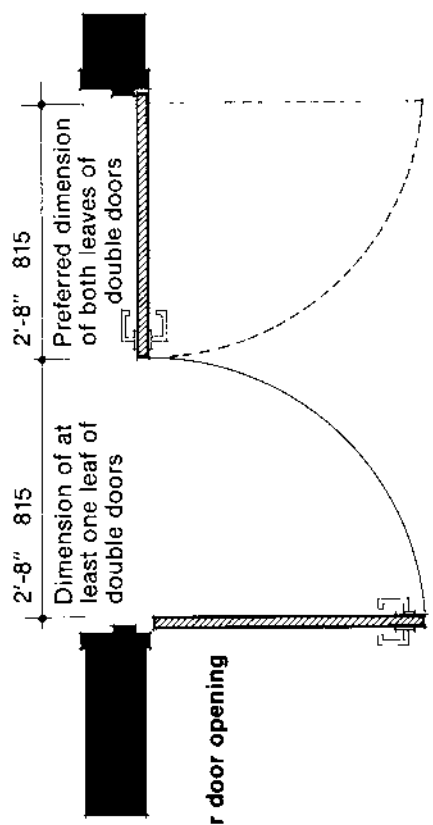
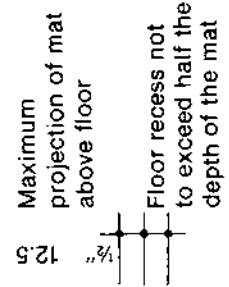


Figure 4.1.6  
Minimum clear door opening



Some exterior thresholds are too high, or not of suitable configuration to allow for the passage of a wheelchair. They can also cause some people to trip.

Raised interior door thresholds often make it difficult or impossible for a person in a wheelchair to pass through the doorway. It compounds the problem of opening and passing through the door, and, in some cases, makes it difficult to turn 90° into a corridor. Thresholds can also cause trips or stumbles for those with gait problems.

Where the bottom rail of a framed glass door is too narrow, a person in a wheelchair, who is using the chair to push open the door, can get the footrest caught against the door stile as the footrest slides across the face of the glass. The same can happen if the door begins to close before the wheelchair has cleared the doorway. The face of the glass gets scratched in the process. The same problems occur with wood panelled doors.

#### **4.1.10**

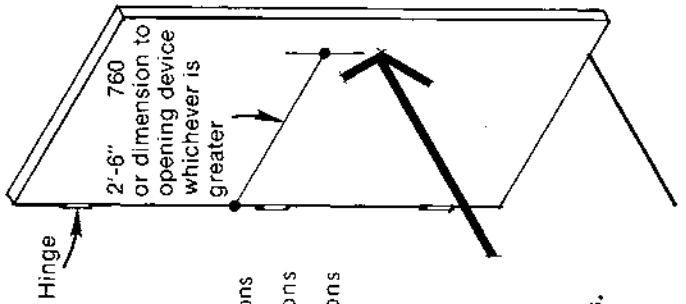
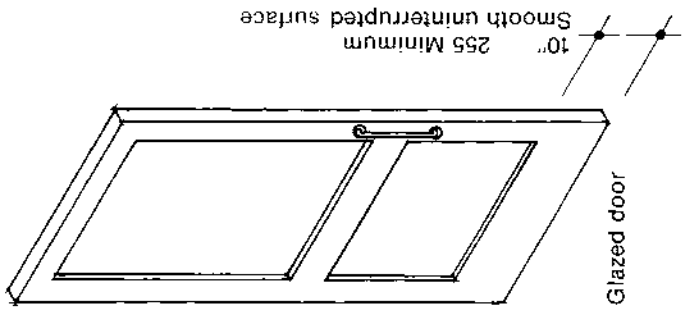
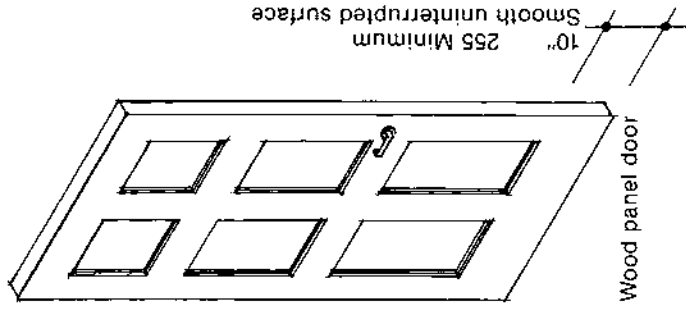
The maximum height of thresholds at exterior and interior doors shall be ½" and they shall be bevelled to allow wheelchair access. They shall not have a vertical change in level. It is preferable that thresholds be flush with the floor surfaces. Where there are differences in floor level between rooms or spaces, the threshold shall be sloped at no more than 1:20.

#### **4.1.11**

Where sliding doors are used as accessible entrances, the opening hardware shall be exposed and usable from both sides when the door is in the open or closed position. Automatic doors are exempt from this requirement.

#### **4.1.12**

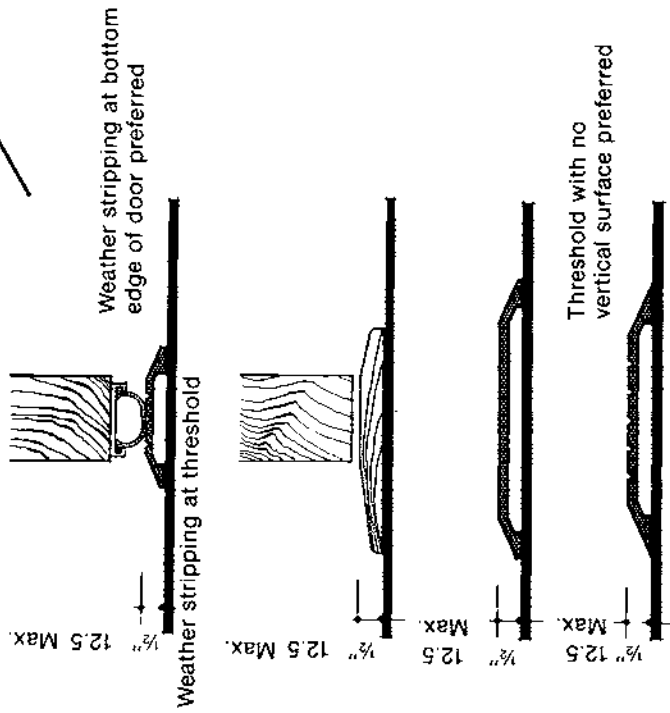
At least the bottom 10" of all doors shall have a smooth and uninterrupted surface. Where narrow frame doors are used, a 10" high smooth panel applied to the frame or a solid flush inset panel raising the height of the bottom rail to 10" are both acceptable. See Figure 4.1.12. Automatic and sliding doors are exempt from this requirement.



Exterior doors	15 lbf	66.6 Newtons
Fire doors	12 lbf	53.3 Newtons
Interior doors	8 lbf	35.3 Newtons

Force applied parallel to floor and at right angles to the door surface

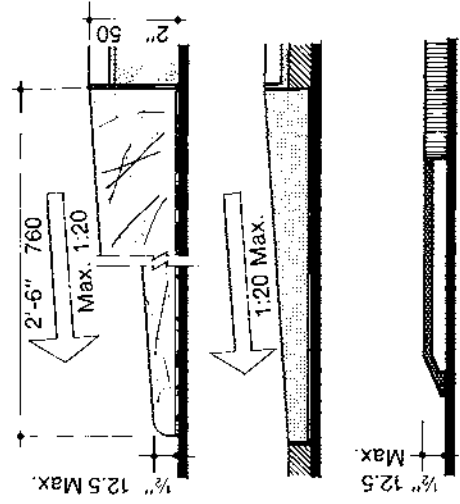
**Figure 4.1.13**  
Opening force requirements for doors.



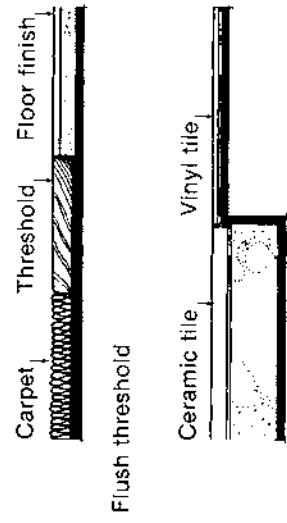
**Maximum height of thresholds**

**Figure 4.1.10**  
Thresholds

**Figure 4.1.12**  
Requirements at the bottom of doors.



**Examples of thresholds at changes of floor level**



**No threshold-depressed floor slab**

Some entrance doors are impossible or difficult to open because of the force required to overcome door spring tension, air conditioning pressure, or high wind forces. Some persons in wheelchairs have to rely on their own momentum to push open heavy doors. This can be dangerous if the door is inadvertently locked.

Persons with balance problems, those who use various prosthetic devices, and many elderly people may have problems when opening heavy doors because of their inability to use their whole body to overcome the weight of the door.

Slippery floor surfaces compound the problems of opening heavy doors, especially for those who are semi-ambulatory or who use prostheses. The prosthesis, such as a rubber crutch tip or artificial leg, can slide when force is applied to it during the door opening sequence. If the person falls, he could also be hit by the door as it closes again.

Framed glass doors which close too quickly hinder the passage of persons in wheelchairs as the stile of the door catches on the foot rests, drive rim, or hub-cap.

Some automatic swing doors do not have adequate sensing devices, and persons can be hit by the door as it opens. If insufficient space is provided in front of the door swinging open, a person can also be hit.

Sometimes it is hard to distinguish a glass door from a glass partition, particularly when storefront is used and the door opening is the same size as the window opening. The visually impaired can find it difficult to locate the entrance. Sometimes it is not obvious to sighted people that floor to ceiling glass partitions are in front of them, and they accidentally walk into them.

#### 4.1.13

The force required to open a door shall not exceed 15 lbf. for exterior hinged doors and 8 lbf. for interior hinged and sliding or folding doors. If the 15 lbf. is exceeded, an automatic assist or an automatic door opener shall be installed on at least one door at the major accessible entrance to the building or facility. The force shall be applied perpendicular to the door at the door push/pull, or 2'-6" from the hinged side of the door, whichever is the furthest distance from the hinge, or parallel to the door at the door opener side of sliding or folding doors, see Figure 4.1.13.

The force required to open a fire door shall be 12 lbf or the minimum force necessary to assure the complete closing and latching of the fire door.

#### 4.1.14

Door closers shall comply with the requirements of 'Door Controls—Closers' ANSI A156.4—1972.

#### 4.1.15

If a door closer is required, then the closing period shall be adjusted so that the door will close in a minimum of 3 seconds from an open position of 70 degrees. Closers shall have a delay feature keeping the door open for a minimum of 5 seconds before beginning to close.

#### 4.1.16

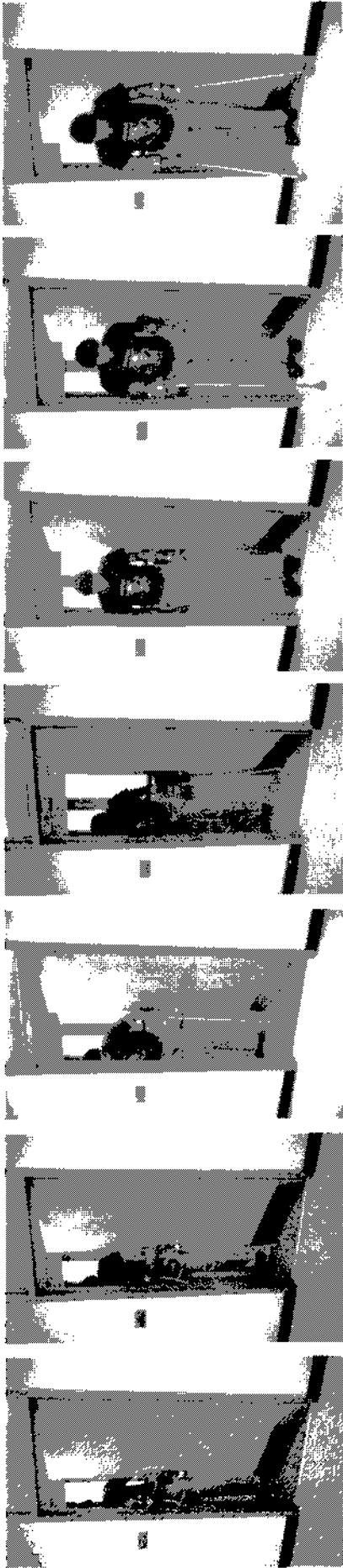
Automatic swing doors shall not open into passing pedestrian traffic unless suitable guard rails or other protective methods detectable by the long cane technique are used to protect passers-by from the swing of the door. Automatic sliding doors are preferred.

#### 4.1.17

Where automatic doors are opened with manually operated pressure plates, these plates shall be located on the push/pull (lock) stile of the door within 4'-0" of the door jamb and located no higher than 3'-4" from the floor surface.

#### 4.1.18

Where floor to ceiling or floor to floor glass walls are used at the entrance level, care shall be taken to insure that the partially sighted and blind have sufficient tactile indication of the entrances. See Fig. 4.1.18 for examples.



Door opening sequence for person using crutches. Heavy doors may trap the crutch tip against the floor.



Body weight has to be applied to the door during the opening sequence if it is too heavy.

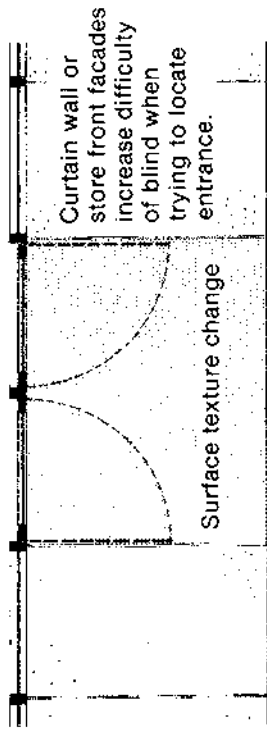
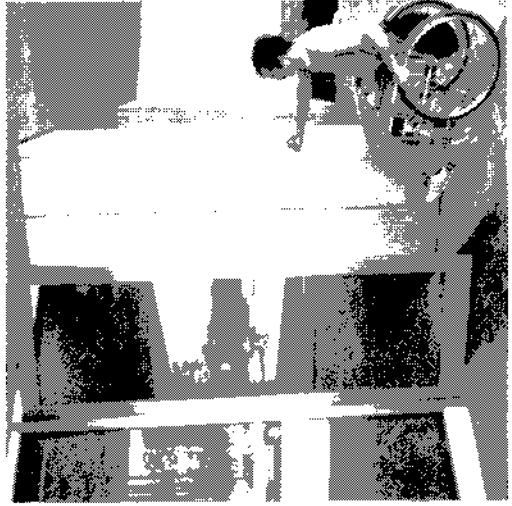
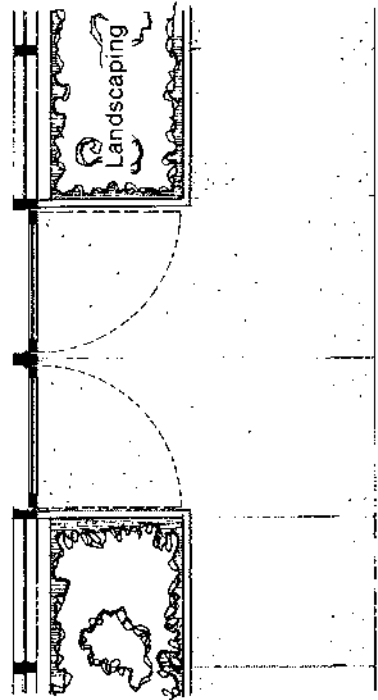


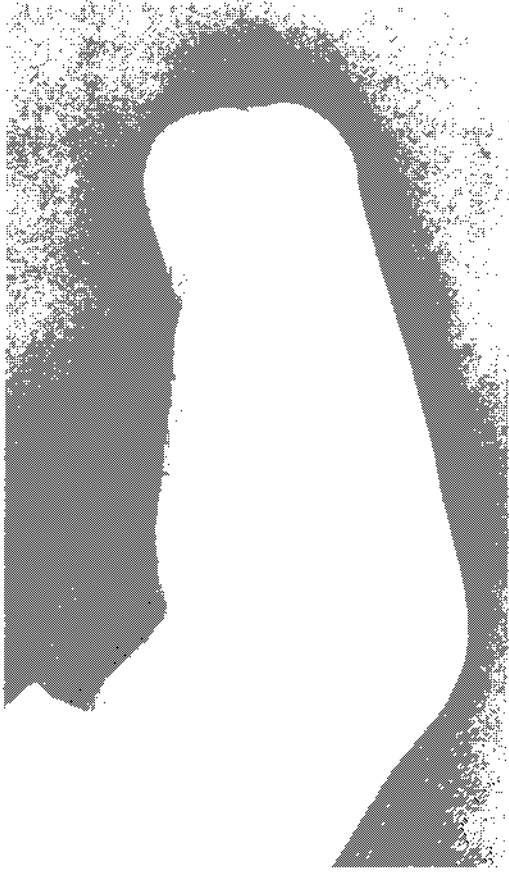
Figure 4.1.18 Examples of ways entrance location can be identified by the blind



The pressure plate which operates the automatic door must be within 4'-0" of the door to ensure that it is readily visible for those using the door.

Photo: Michael A. Jones

Door knobs are difficult for many people to operate because of the need to grasp and twist the wrist to open them. It is especially difficult for upper-limb amputees, quadriplegics, arthritis and small children.



Amputation above wrist.

Photo: Scott Schiesser

## 4.2 DOOR HANDLES

Doors shall be operable without movements requiring a tight grasp, complex hand movements, or the exertion of great force. Automatic doors shall be safe and usable by the majority of people, including the handicapped.

Some entrance door hardware requires fine finger manipulation, especially locking devices.

Some panic hardware requires too much force to operate. There is often no clear instruction on how to operate the panic bar.

Persons with upper limb impairments or arthritis in their hands may use their arm to pull open the door, but many times the design of the pull-handle does not allow sufficient space between the handle and the door surface for their arm.

**4.2.1** All manual door openers shall have a lever design or other shape which does not require grasping and twisting of the wrist as the only means of operation. They shall be mounted 3'-0" to 3'-8" from the floor surface to the center of the actuating portion of the device, see Figure 4.2.1.

**4.2.2** Manual door openers shall be designed with no sharp corners or edges. The opener shall be chosen that minimizes the catching of clothes on the device.

**4.2.3** Clearance between the handle and the door shall be a minimum of 2" to allow the door to be pulled open by using the arm.

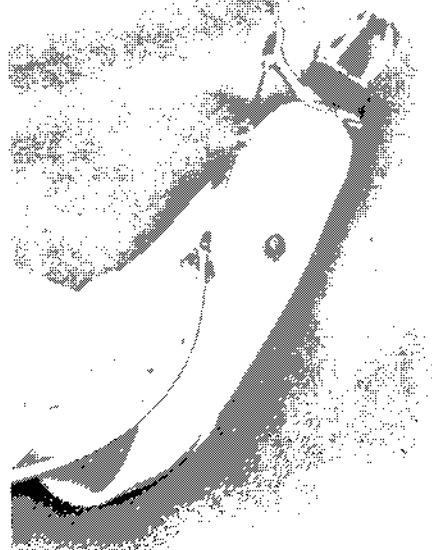


Photo: Scott Schlessner



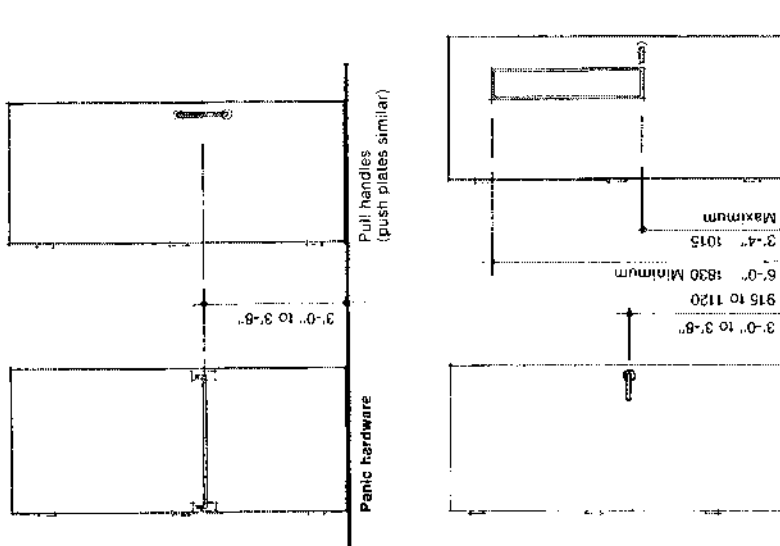
Photo: Scott Schlessner



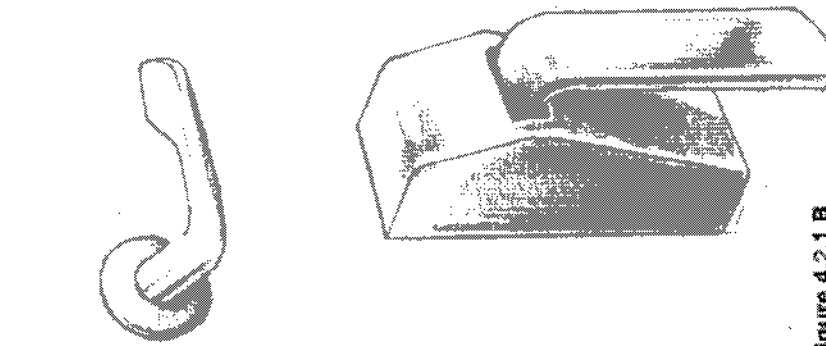
Photo: Peter Wachter

**Prosthetic devices.**

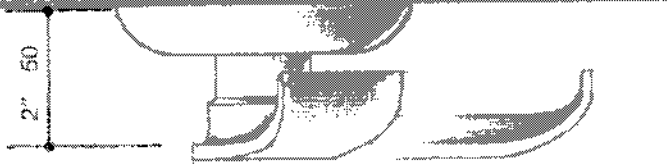
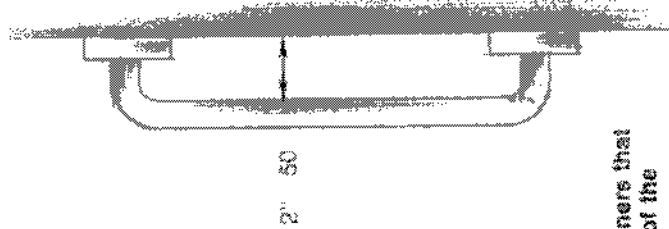
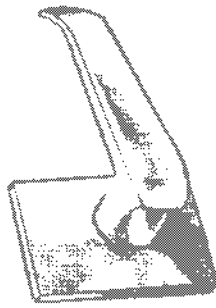
Levers can be operated with imprecise movement by most people.



**Figure 4.2.1 A**  
Mounting height of manual door openers



**Figure 4.2.1 B**  
Typical examples of manual door openers that do not require grasping and twisting of the wrist as the only means of operation





Where there are no obvious door handles provided, visually impaired persons may have difficulty locating the door. For example, an aluminum push plate mounted flush on an aluminum door frame might not be distinguishable if there is no color contrast. A glazed door might appear to look like another window in a window wall.

Where push bars extend from stile to stile, there is often no way of knowing at which side the bar has to be pushed to open the door.

#### 4.2.4

Where door push plates are an integral part of the door stile, the push plate shall be of a contrasting color.

#### 4.2.5

Where the door opening device is a bar extending from stile to stile, the side of the bar to be pulled or pushed shall be distinguished with a change of color and texture.

#### 4.2.6

The hardware provided for doors into fire stairs, fire corridors or exits and hazardous areas, e.g., electrical switchrooms, shall be provided with a change in texture, either by knurling or by applying an abrasive finish to the handle, see Section 12.2.3, Emergency Warning Signals and Alarms.

### 4.3

#### DOOR SIGNS

#### 4.3.1

For door signs, see Section 12.1, Signage, and Figure 4.3.1.

Some entrances are poorly illuminated at night, making signs and numbers difficult to read, particularly when viewed from a car or bus. A disabled driver has to get his chair out of the car to wheel close enough to verify an address. This is time and energy consuming.

Inadequate identification of individual offices and/or rooms presents a problem to the blind and the deaf (who have problems communicating verbally). Lack of proper identification can also affect those who are apprehensive in unfamiliar surroundings or who are frightened to ask directions of strangers.

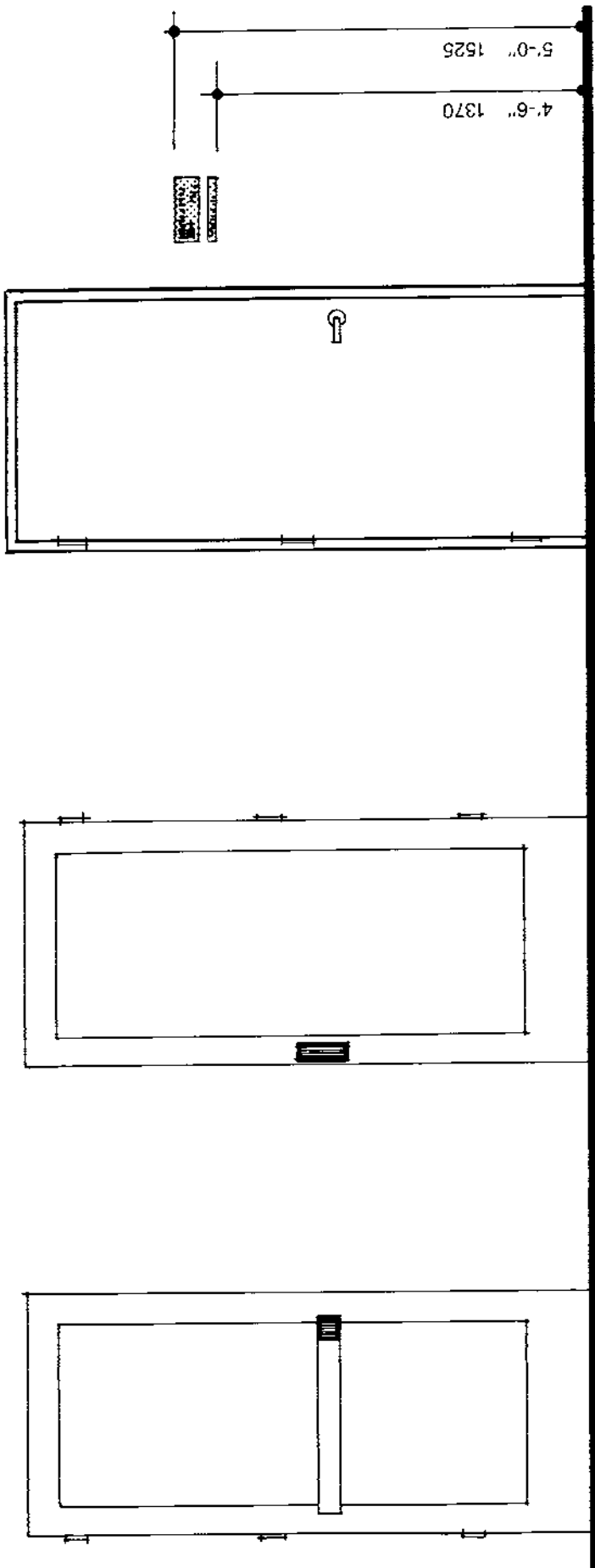


Figure 4.3.1  
Mounting height and position of room  
identification

Figure 4.2.4 and  
Figure 4.2.5  
Contrast in color required on manual door  
openers.

Corridors with steps, and corridors which are too narrow to maneuver a wheelchair are barriers which can deny a person housing, education, employment, or recreation.

## 5.1

### INTERIOR CIRCULATION ROUTES

There shall be an accessible and convenient path of travel from accessible entrances to all accessible areas within a building or facility. There shall be accessible means of emergency egress or a place of refuge in an emergency from all accessible spaces within a building or facility.

#### 5.1.1

All accessible spaces in a building or facility shall be served from an accessible entrance by at least one path of travel that does not have stairs or escalators.

#### 5.1.2

People who cannot use stairways are handicapped in emergency situations which require the evacuation of buildings of two or more stories. Elevators usually return to the ground floor in the case of fire or other emergency, trapping the non-ambulatory above the ground floor.

Every accessible space shall be served by a path of travel that does not have stairs or escalators to at least one means of egress or refuge in an emergency. The following alternatives are acceptable:

- a. A horizontal exit shall be provided that meets the requirements of the American National Standard Code for Life Safety from Fire in Buildings and Structures, ANSI A. 9.1—1974 (NFPA 101—1973) for horizontal exits; or
- b. The elevator lobbies shall be separated from the other portions of the building by construction having a fire-resistive rating of not less than two hours, have positive pressurized elevator shafts with the elevators capable of being operated by a separate emergency power system provided, and have at least one elevator made available for use by authorized people to assist the handicapped; or
- c. Elevators shall meet requirements of administrative authorities as approved means of egress, and have an approved evacuation plan in the case of an emergency; or
- d. Stairways required as means of egress shall have accessible landings at floor levels with spaces that have at least 10 sq. ft. of clear floor area in addition to that required for exiting. This space shall be accessible to, and have a configuration that will accommodate one wheelchair in positions that do not obstruct people exiting. Stairways, and access to them, shall provide a protected enclosure no less restrictive than the requirements of ANSI A. 9.1—1974 (NFPA 101—1973, Section 5-114).



**5.1.3**

All drinking fountains, public toilet rooms, fire alarms, vending machines and public telephones shall be located adjacent to accessible paths of travel and shall meet the applicable requirements of this standard.

There is insufficient room to maneuver some wheelchairs through a 2'-8" doorway in the side of a 3'-0" wide corridor.

**5.1.4**

The minimum clear width of halls, corridors, passageways and aisles shall be 3'-0". Where there is likelihood of there being several persons in wheelchairs in a building, the minimum width of halls, corridors, passageways and aisles shall be 5'-0" to allow wheelchairs to pass. See Figure 5.1.4.

Doors that open directly onto descending stairs can be hazardous for people in wheelchairs, or those who have balance and agility problems.

**5.1.5**

Stairways shall not lead directly into or out of a path of travel, unless a tactile warning is provided. See Section 6.2.4, Stairs.

**5.1.6**

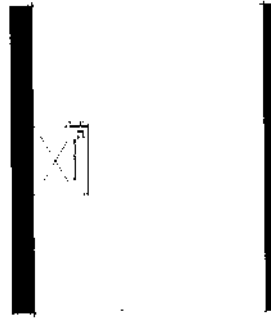
The blind and visually impaired may be struck about the head, shoulders and body by signs or other projections from walls and ceilings which are out of the locatable area of a white cane.

No rigid or hard object shall project into the space above a path of travel unless the dimension from the bottom edge of the object to the walk surface is at least 7'-6". Below this height, protruding objects which project more than 4" from a wall or column must:

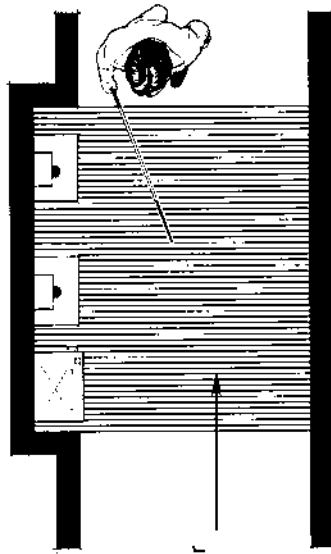
- a. continue to the floor; or
- b. to within 8" of the floor; or
- c. be located in protected areas which are recessed or enclosed by wing walls. Such a protected area shall have a contrasting floor texture and color.
- d. Doors and door closers do not have to conform to this requirement.
- e. Where low ceiling heights prohibit the placing of Emergency Exit signs at 7'-6" above the floor level, these signs may be placed at 6'-6" from finished floor level to the bottom of the sign.

See Figure 5.1.6.

Any item in a walk or corridor which is not recessed or protected by wing walls must extend to the floor or to within 8" of the floor.

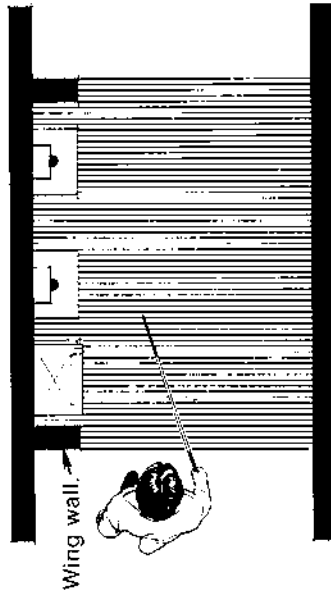


A. Projecting drinking fountain.



Change in floor texture and color provides a blind location cue.

B. Recessed wall hung drinking fountain and telephones.



C. Wall hung drinking fountain and telephones protected by wing walls.

Figure 5.1.6 Alternative methods of protecting projecting objects in walks and corridors.

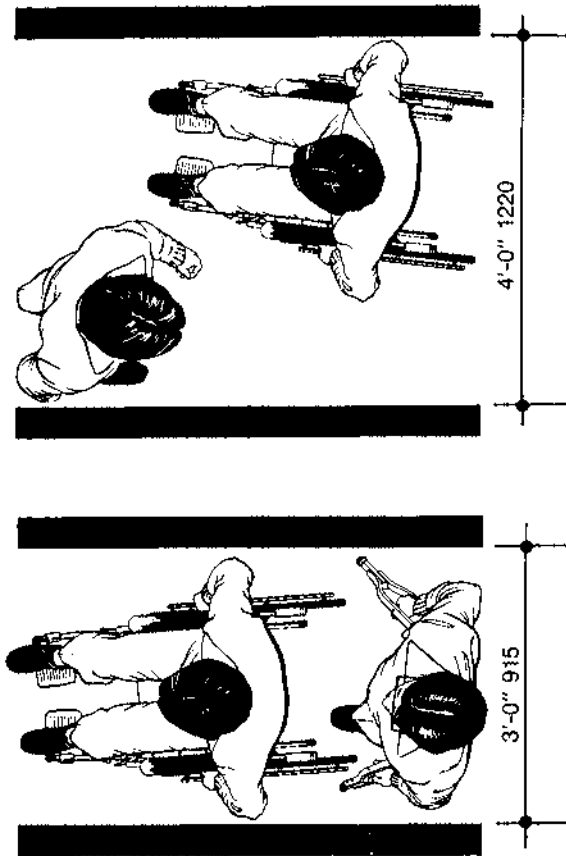


Figure 5.1.4A Minimum corridor width. Does not allow passing.

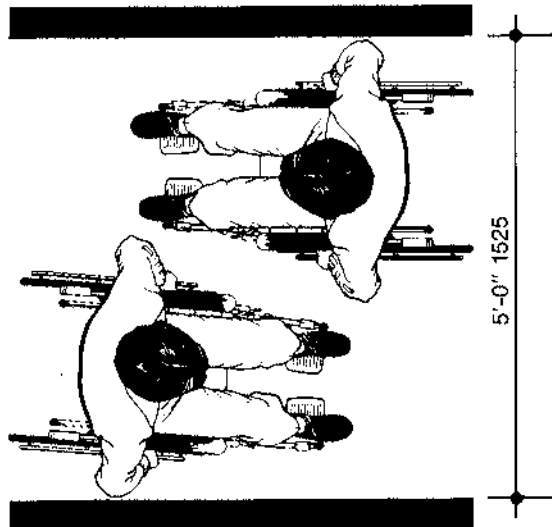


Figure 5.1.4C Minimum corridor width which allows two wheelchairs to pass.

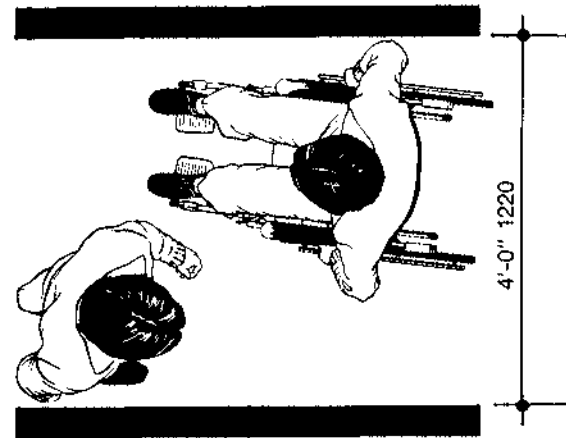


Figure 5.1.4B Minimum corridor width which allows passing of a pedestrian and a person in a wheelchair.

People confined to wheelchairs cannot ascend or descend stairs. Even some people who are ambulatory or semi-ambulatory can have difficulty.

Steep ramps are difficult or impossible for some people to ascend or descend. Not everyone in a wheelchair has the stamina to cope with ramps. Persons with an artificial leg or leg brace may prefer to use a stair or curb rather than risk using a steep ramp.

If a ramp is too steep, wheelchair footrests can hit or scrape the level surface at the bottom of the ramp, bringing the chair to a sudden stop and causing the person to be thrown out of his wheelchair. The same thing could happen when there are two different slopes on a ramp and the person in the wheelchair cannot see the change. Long ramps are difficult or impossible to negotiate for people who use wheelchairs or walking aids, unless they have level, resting places at intervals. These people can tire quickly due to the exertion required to negotiate the slope.

Persons with a prevalence of fainting or dizziness and those with stamina and agility limitations may have problems using steep or long ramps.

Temporary ramps, not fixed in position, are hazardous because they often move away from the vertical surface of the existing step, creating a joint that can stop a caster-wheel on a wheelchair or cause a trip.

There is usually a lip at the bottom of temporary ramps which is hazardous to ambulatory and non-ambulatory alike.

Exterior ramps are slippery when wet or icy.

## **RAMPS**

### **6.1**

If possible, alternative design solutions to ramps should be provided because of the substantial energy demands required to negotiate them by those in wheelchairs, plus the difficulties encountered by amputees and others with gait problems on ascent and descent. Stairs or elevators should be provided in addition to ramps. Ramps shall allow unrestricted traffic flow, and be free of hazards. All ramps constructed in a building or facility and site shall meet the requirements of this standard.

#### **6.1.1**

Any part of a circulation path shall be considered a ramp if it has a slope that is greater than 1:20. Table 6.1.1 gives allowable slopes and maximum lengths. All ramps in a rampway shall have identical slopes. A slope of 1:20 is preferred for ramps of all lengths. The maximum slope of ramps shall be 1:12 in new construction. Ramps of 1:8 and 1:10 may be used where existing physical constraints prevent the construction of more gradually sloped ramps.

#### **6.1.2**

All ramps occurring along a permanent accessible path of travel or fire exit shall be of permanent fixed construction.

#### **6.1.3**

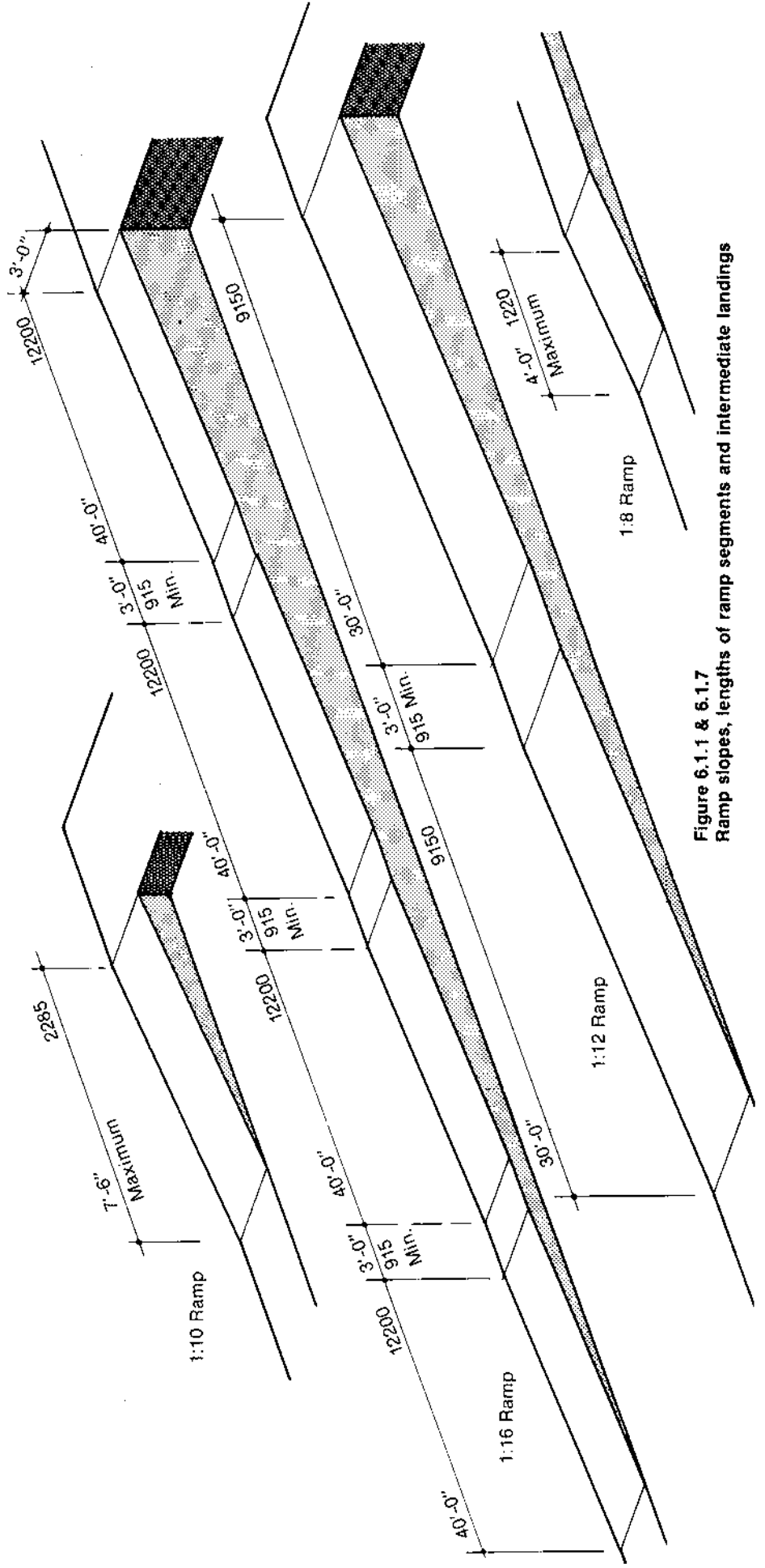
Exterior ramps shall not begin or end in an area where standing water will accumulate on the walking surfaces.

#### **6.1.4**

Weepholes in retaining walls abutting exterior ramps shall not drain across the surface of the ramp.

**TABLE 6.1.1 ALLOWABLE SLOPES AND MAXIMUM LENGTHS OF RAMPS**

Allowable Slope	Maximum Rise in a Single Ramp Segment	Total Rise of Ramp	Total Number of Ramp Segments Permitted	Total Rise That Can Be Accomplished	Maximum Length of a Single Ramp Segment	Total Length of Ramp	Use
1:8	6"	6"	1	6"	4'-0"	4'-0"	Curb-ramps when it is impossible to achieve slope of 1:12 or 1:10 because of site constraints
1:10	9"	9"	1	9"	7'-6"	7'-6"	Curb-ramps when it is impossible to achieve a slope of 1:12 because of site constraints
1:12	2'-6"	5'-0"	2	5'-0"	30'-0"	60'-0" plus landing	Curb-ramps and ramps
1:16	2'-6"	10'-0"	4	10'-0"	40'-0"	160'-0" plus landings	Curb-ramps and ramps



**Figure 6.1.1 & 6.1.7**  
Ramp slopes, lengths of ramp segments and intermediate landings



Ramps with one handrail can be difficult to use for people whose disability results in only one usable hand. If there are neither handrails nor raised curbs at the sides of the ramp, there is a danger of a wheelchair rolling off, or the possibility of a walking aid slipping off the edge of the ramp.



A second handrail would make this ramp easier to use.

Narrow ramps are difficult for some people to negotiate if they have balance problems or use a wheelchair. In both cases, their route of travel may be imprecise, and they may require additional space for tracking error. It is difficult for people to pass one another on narrow ramps.

### 6.1.5

All ramps with a rise greater than 9", except curb ramps, shall have handrails on both sides. The handrails shall be 2'-6" to 2'-10" in height, measured vertically from the surface of the ramp, and shall extend at least 1'-0" beyond the top and bottom of the ramp segment. Handrails shall be continuous along the rampway. If children are principal users of the building, then a second set of handrails shall be provided at a height of 2'-0". Handrails shall comply with Section 6.3, Handrails and Guardrails.

### 6.1.6

Wheelchairs, walking aids and feet shall be protected from slipping off the edges of the ramp. See Figure 6.1.6.

### 6.1.7

Ramps shall have a minimum clear width of 3'-0". Where passing of wheelchairs can be expected on the ramp, the minimum clear width shall be 5'-0".

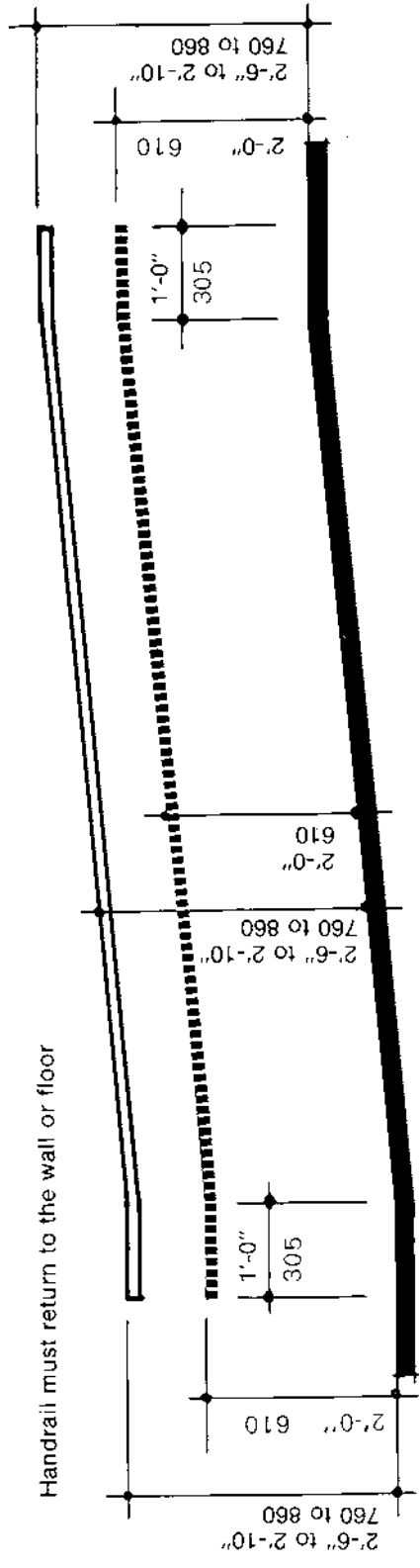


Figure 6.1.5 Handrail requirements on ramps

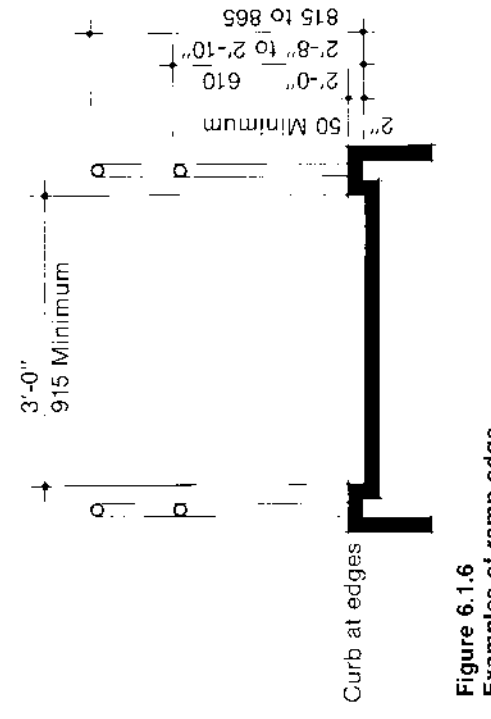
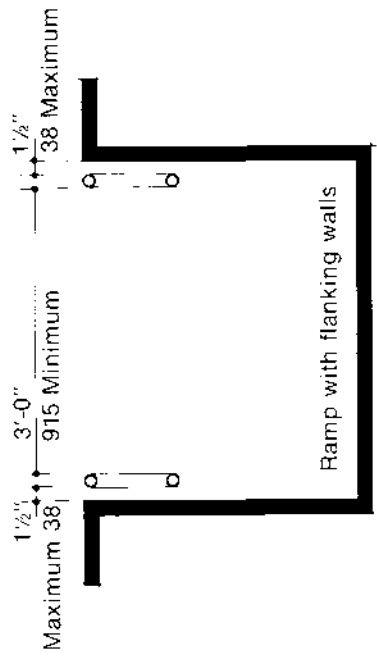


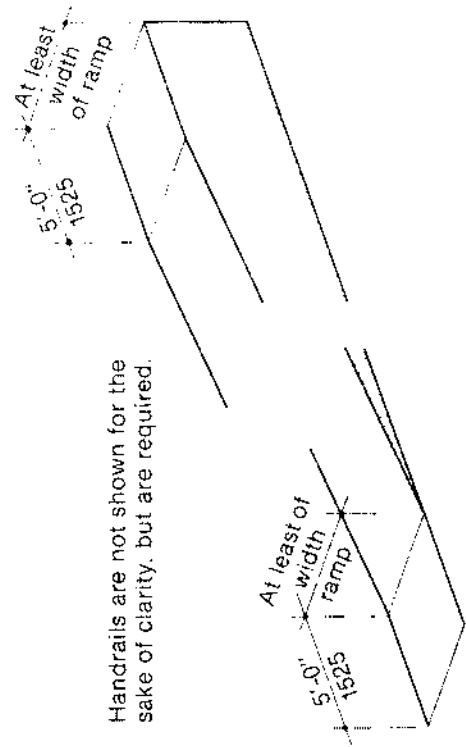
Figure 6.1.6 Examples of ramp edge

#### **6.1.8**

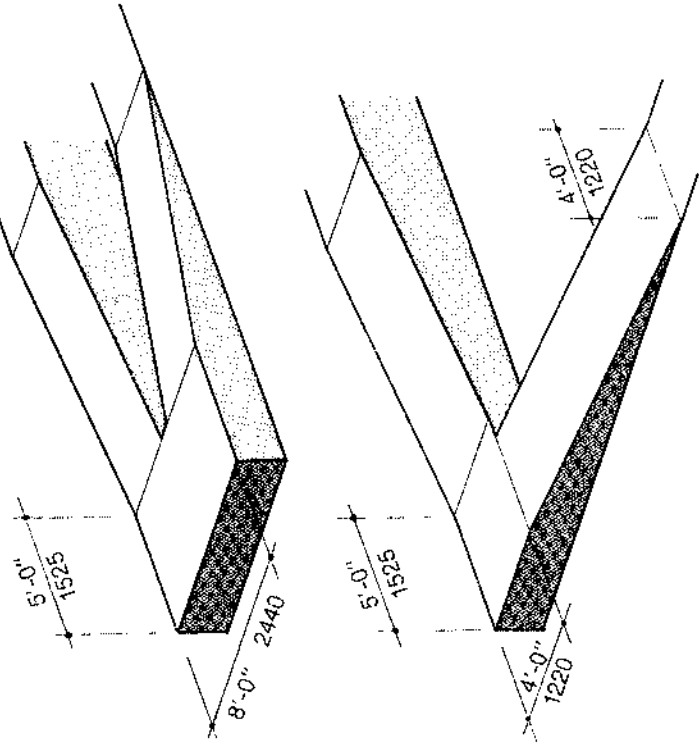
Ramps shall have level platforms at the bottom and the top of each run, at least 5'-0" long and be at least as wide as the ramp. Intermediate platforms shall be 3'-0" minimum between each ramp segment. See Table 6.1.1 for the maximum allowable lengths of ramp segments.

Intermediate platforms shall be a minimum of 5'-0" deep and 8'-0" wide to allow wheelchair maneuvering through 180°; and at least 5'-0" deep and 4'-0" wide for turns of 90°. See Figure 6.1.8.

Handrails are not shown for the sake of clarity, but are required.

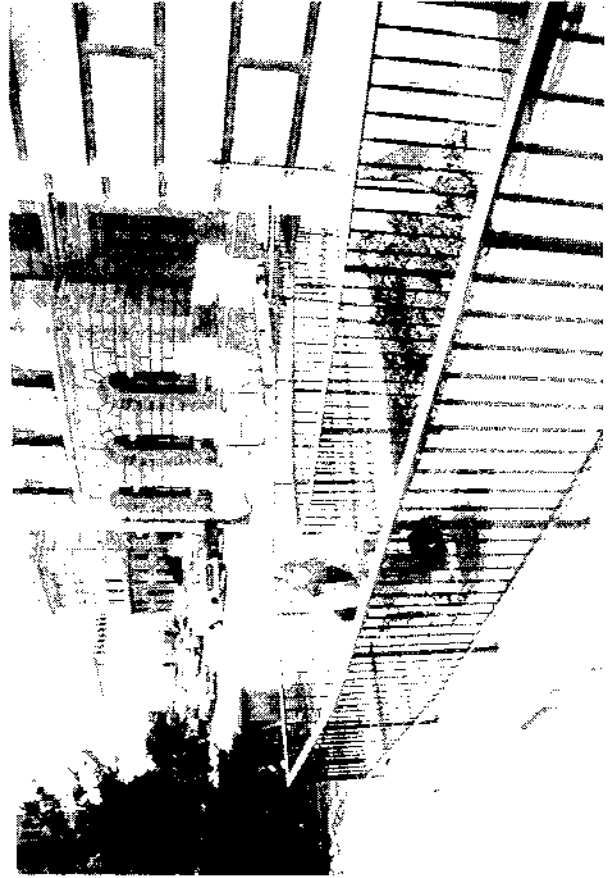


Minimum requirements for level platforms at top and bottom of ramps.



Minimum requirements for intermediate turning platforms

Ramps can be designed to be aesthetically harmonious with the rest of the building.



A ramped alternative entrance added to a church.

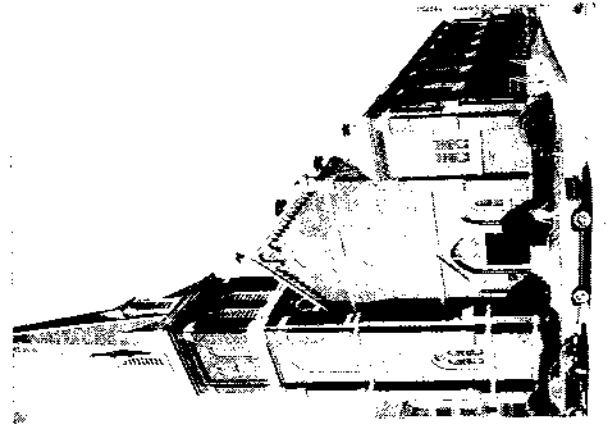


Figure 6.1.8

- 6.1.9** If doorways are located at the platforms, the area in front of the doorway shall comply with Section 4.1.1 Doorways. If doors open out onto the ramp platform, a level area at least 5'-0" deep and 5'-0" wide shall be provided. See Figure 6.1.9.
- 6.1.10** The ramp surface shall be slip resistant. See Section 13.1.5, Ground and Floor Surfaces.
- 6.1.11** No object shall be hung from above or the sides that projects into a rampway lower than 7'-6" from the surface of the ramp or landing. Below this height, no object shall project into a rampway other than the handrails.



A good example of a ramped approach and level area in front of entrance doors.

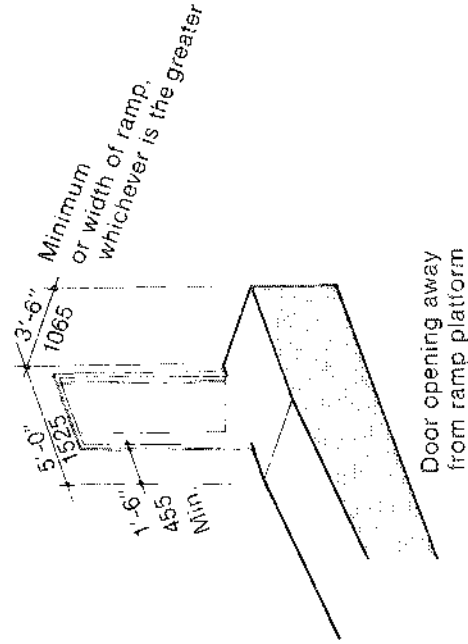
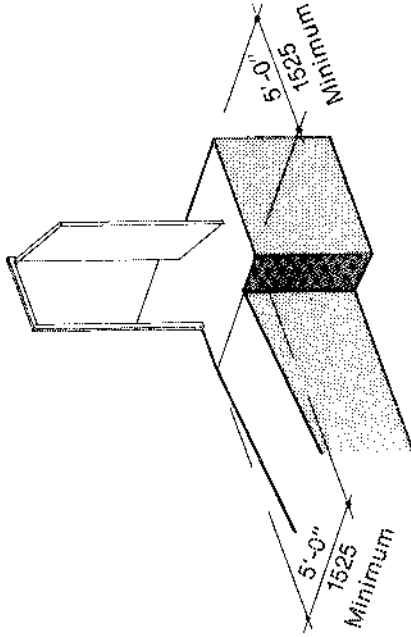


Figure 6.1.9  
Minimum requirements for level platforms with door openings adjacent

Small risers of 2" or less are difficult to see, making some people mistake shallow stairs for ramps, especially when approaching from the top of the flight in bright sunlight or in the dark. When the stair is of a light color, the nosings are not apparent or distinguishable in strong sunlight. There are often no handrails on shallow stairs which would give a visual cue or prevent falling.

Stairs with high risers are difficult for most people to use, but especially so for elderly people and children.

Tread depths that are too small are hazardous for some people, as they cannot place their foot adequately on the tread.



Photo: Michael A. Jones

Shallow stairs are sometimes mistaken for ramps, particularly if shadows from surrounding trees fall on the stairs.

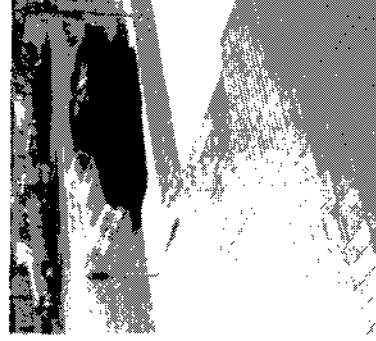


Photo: Michael A. Jones

Stair nosings cannot be distinguished from brick joints. Handrails would indicate that there are stairs ahead.

Square nosings make it difficult for some people to ascend stairs. When a person with a fixed ankle brace or stiff leg gets the top of his shoe caught below this type of nosing, it is difficult to free the foot and a trip or fall could result.

If exterior walks and stairs are dappled with shadows from surrounding trees or shrubs, the nosings may not be easily distinguishable.

Heavily patterned floor surfaces on stairs make it difficult to distinguish the nosings. This is true of carpeted stairs and also brick stairs, where the joints parallel the nosing. It is very difficult to determine whether lines are joints or nosings.

Strong sunlight entering stairwells may create glare to the extent that nosings cannot be distinguished. The elderly have severe problems with glare, as their eyes require longer periods of time to adjust to changes in light levels.

## 6.2 STAIRS

Stair risers shall be no less than 4" high nor more than 7" high, measured from tread to tread. The minimum width of the tread shall be 11" from nosing to nosing. Stair proportions shall conform to Fig. 6.2.1 in order to accommodate the natural, informal gait.

### 6.2.1

All risers and treads shall have uniform dimensions on any given flight of stairs.

### 6.2.2

Stair treads shall not have abrupt or squared nosing configurations. The maximum nosing projection shall be 1/2". The radius of curvature at the edge of the tread shall be no greater than 1/2". The edge of the nosing shall be clearly distinguishable, see Section 13.1.4. Ground and Floor Surfaces.

### 6.2.3

FIGURE 6.2.1

ACCEPTABLE RANGE OF TREAD/RISER RELATIONSHIPS

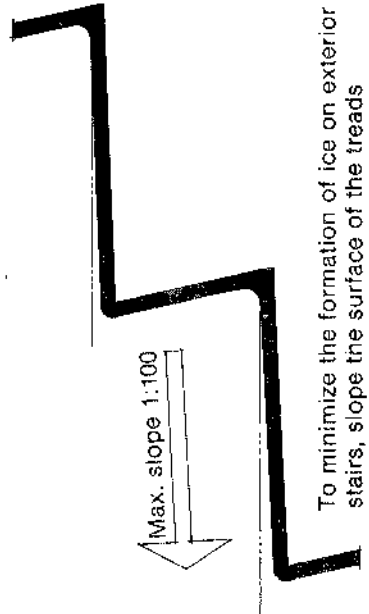
TREAD WIDTH IN FEET AND INCHES				RISER		TREAD WIDTH IN MM								
1'-2"	1'-1 1/2"	1'-1"	1'-0 1/2"	1'-0"	11"	INCHES	MM	279	292	305	318	330	343	356
						7	178							
						6 1/2	165							
						6	152							
						5 1/2	140							
						5	127							
						4 1/2	114							
						4	102							



A sequence showing a person with a fixed ankle brace climbing a stair. A square nosing prevents the toe from completing this movement, and smooth nosing allows the foot to

slide up the riser and onto the tread. A square nosing prevents the toe from completing this movement, and smooth nosing allows the foot to

climbing the stair may be difficult or dangerous.



To minimize the formation of ice on exterior stairs, slope the surface of the treads 1/8" in 1'-0" 1:100.

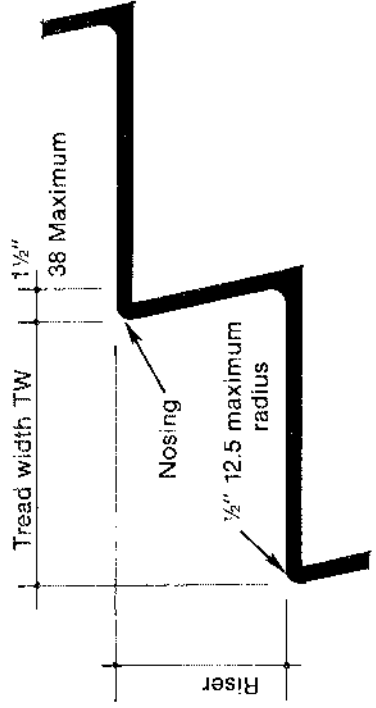


Figure 6.2.3 Accessible stair



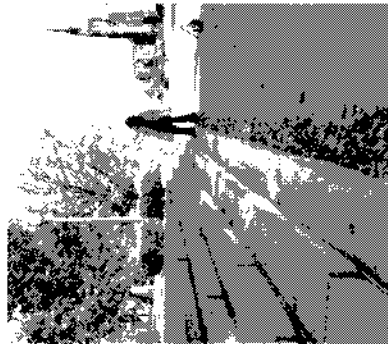
Staircases that occur abruptly off circulation corridors are hazardous to all people, but are particularly so for the visually impaired and those with incoordination.

The surfaces of some stairs are slippery. The problem is compounded in situations where the nosing of the stair is excessively rounded and has become worn. This can be readily seen on marble or stone staircases where the stair has the heaviest volume of traffic.

Where only one handrail has been provided, those who rely on them for support have difficulty using a staircase, especially when people pass each other on the stair. Handrails at both sides of the stair are needed so that there is always support when going up or down.

People with balance difficulties have problems using exterior stairs that are not protected from the wind, particularly when there are no handrails provided. Exterior stairs are often slippery when it is wet or icy.

If the handrail does not extend beyond the bottom riser of a flight of stairs, the blind may not be aware that there is another step ahead. If the handrail does not extend beyond the top riser, a valuable location cue for the visually impaired is missing. People who rely on crutches often use the handrail as a support when climbing and descending stairs. If the handrail does not extend above the landing, the last step down or the first step up can be difficult to negotiate.



Handrails make ascent and descent of stairs difficult for some, and dangerous for others in inclement weather.



Handrails which do not project beyond the bottom tread are difficult for some who use them as a mobility aid. Projecting handrails also serve as a stair location cue for the visually impaired.

#### 6.2.4

Where a stairway intersects a circulation path at right angles, the first riser shall be set back at least 2'-6" from the circulation route. Tactile warning cues for the blind shall be located from the edge of the path of travel to the top nosing of the stair, see Section 12.3, Tactile Floor Surface Alerts, and Figure 6.2.4.

#### 6.2.5

Stair treads shall have surfaces which are non-slip, see Section 13.1.4, Ground and Floor Surfaces.

#### 6.2.6

Stairs shall have continuous handrails at both sides, and shall be located 2'-6" to 2'-10" measured vertically from the surface of the tread. Where children are the principal users of a building, a second set of handrails shall be provided at a height of 2'-0" measured vertically from the surface of tread. Handrails shall extend a minimum of 1'-0" beyond the top riser and 1'-0" plus the tread width beyond the bottom riser. The extension shall be parallel with the landing floor surface, see Figure 6.2.6. Handrails shall comply with Section 6.3, Handrails and Guardrails.

#### 6.2.7

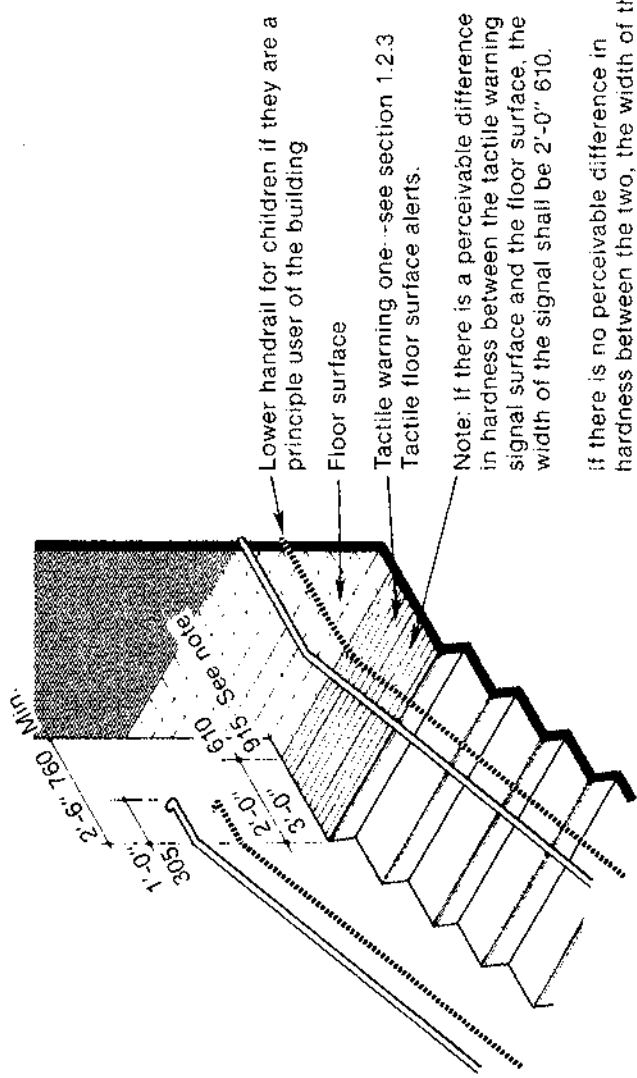
Exterior stairs shall not begin or end in an area where standing water will accumulate on the walking surfaces.

#### 6.2.8

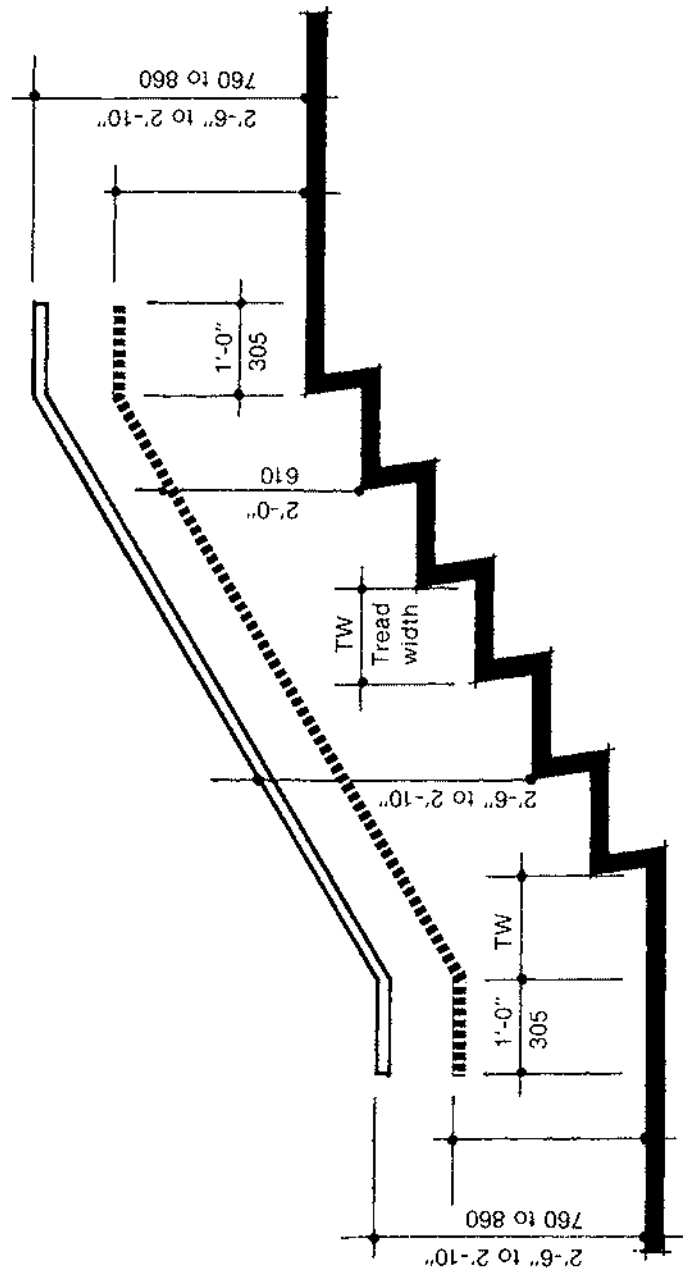
Weepholes in retaining walls abutting exterior stairs shall not drain across the surfaces of the treads.

#### 6.2.9

No object shall be hung from above or the sides that projects into a stairway lower than 7'-6" from the surface of any tread or landing, measured vertically. Below that height no object shall project into a stairway other than handrails, stair stringers and door hardware.



**Figure 6.2.4**  
Requirements for a stairway intersecting a circulation route



**Figure 6.2.6**

**6.2.10**

When a circulation space occurs beneath a stair, a barrier shall be provided to prevent persons from hitting their heads on any part of the stair. Any part of the flight of stairs occurring below a height of 7'-6" measured to the floor shall be so protected. See Figure 6.2.10.

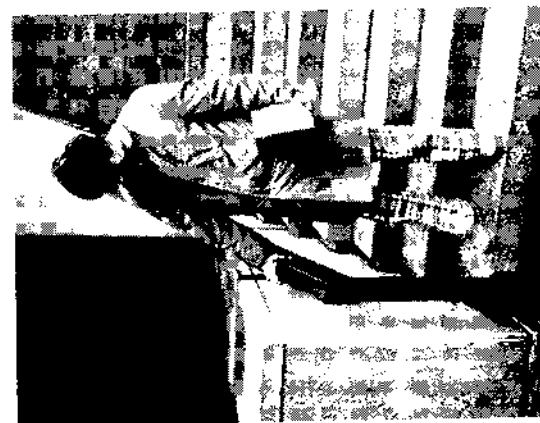
Where a free-standing staircase rising to the floor above is located so that there is circulation around all sides, there is a danger that a blind person approaching the stair from the side or rear may bang his head if no locatable warning is provided.

Long flights of stairs are difficult for those with reduced stamina or agility because of the substantial energy demands that have to be expended negotiating them.

Steep or long staircases are potentially hazardous for those who have a high risk of seizures or who suffer from vertigo. The thought of using them can frighten some people.

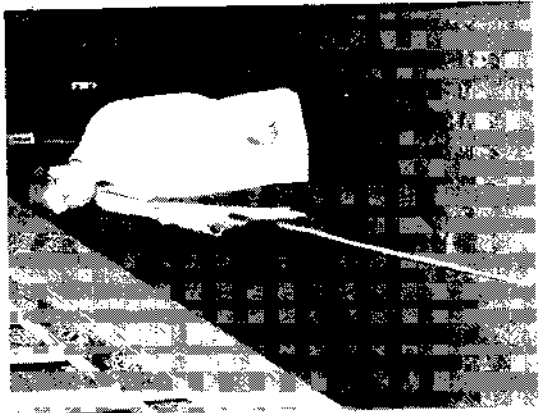
Stairs with low light levels can cause missteps or falls because the nosing is difficult to detect.

Handrails are frequently too large or poorly shaped to be grasped securely by those who rely on them for support, such as children, others with small hands, or people who have arthritis.



Handrail is too wide to grip safely and securely.

Photo: Michael A. Jones



Stairs that descend in circulation spaces can be hazardous to blind people who may not be able to locate them with the white cane.

Photo: Lloyd Weber

**6.3**

**HANDRAILS AND GUARDRAILS**

**6.3.1**

Handrails shall be designed to permit continuous sliding of hands. The hardware chosen for attaching handrails to balusters or walls shall be such that no projecting lugs, devices, or other construction elements shall interrupt the continuous sliding of the hand, or engage loose clothing.

**6.3.2**

The anchoring of posts and framing of members for handrails and guardrails shall be of such construction that the completed structures shall be capable of withstanding a load of at least 250 lbf. applied in any direction at any point on the top rail.

**6.3.3**

Handrails shall be designed to allow the natural opposing grip. The outside diameter or width of the rails shall be 1 1/4" to 1 1/2". See Figure 6.3.3.

**6.3.4**

Handrails and guardrails, including fasteners, shall have no sharp edges or dangerous protrusions. Edges shall have a minimum radius of 1/8".

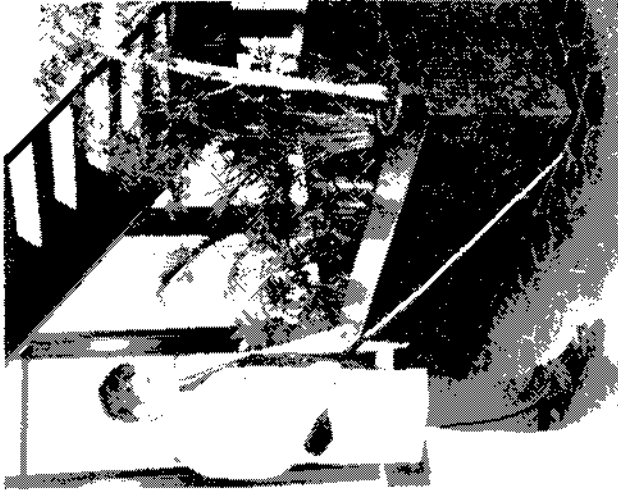


Photo: Lloyd Weber

This planter below a main stair provides a locatable barrier for a blind person, and prevents him from banging his head on the underside of the stair.



Person with crutches using the hand-rail as a mobility aid.

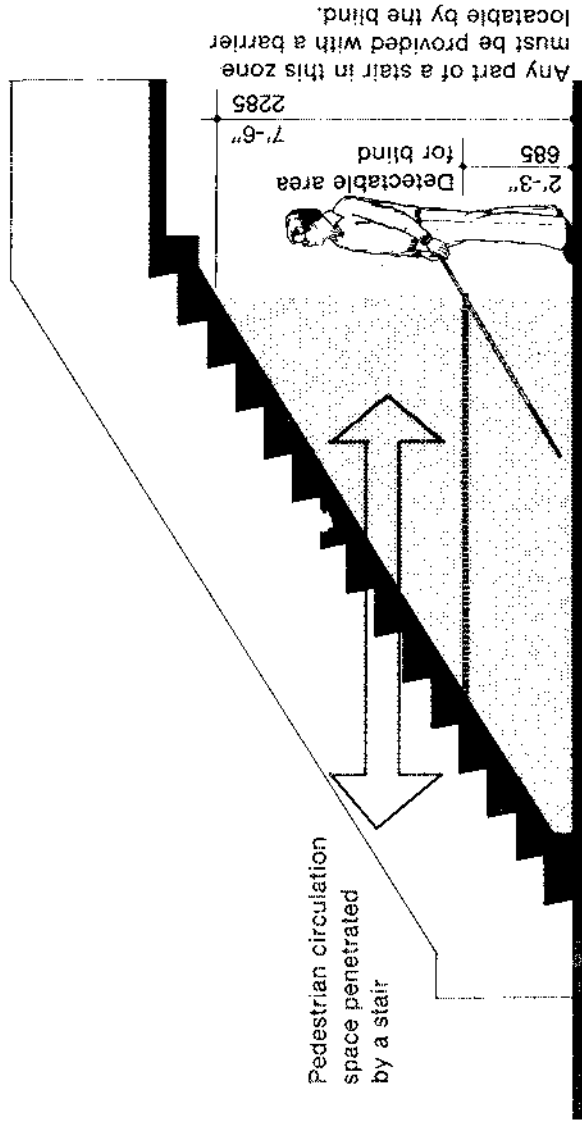


Figure 6.2.10  
Pedestrian circulation space penetrated by a stair

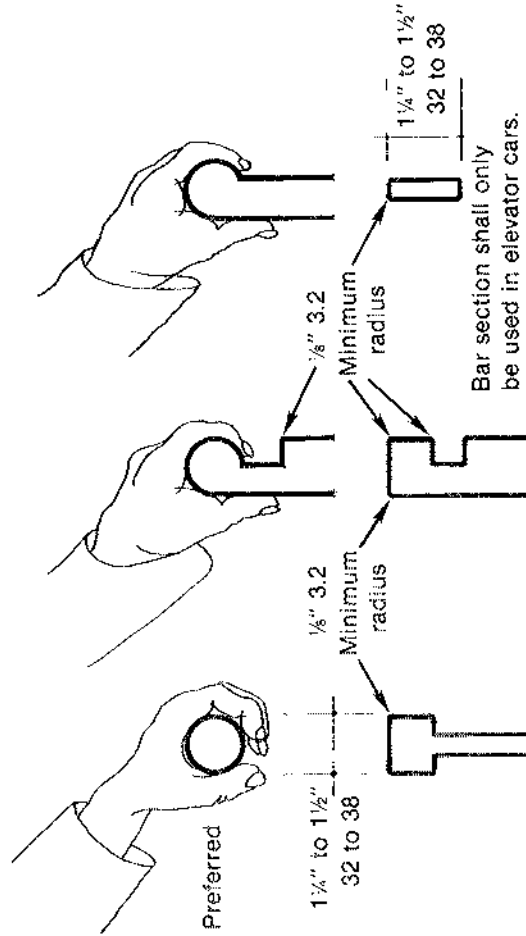


Figure 6.3.3  
Sections through acceptable handrail profiles—graspable part only.

Handrails shall have a maximum clearance of 1½" between the rail and the wall. When the surface of the wall is rough, e.g., concrete or masonry, protection shall be required behind the handrail to prevent knuckles being scraped on the wall surface, except in fire-stairs and buildings with alternate methods of vertical circulation. See Figure 6.3.5.

**6.3.5**

Projecting ends of handrails or guardrails shall return smoothly to the wall, floor or post.

**6.3.6**

A raised strip, ⅝" high and raised ⅛", shall be placed on the top surface of the handrails of enclosed stairs at the main exit floor.

**6.3.7**

Every stairway required to be more than 7'-4" wide shall have intermediate handrails dividing the stairway into portions not more than 7'-4" wide.

**6.3.8**

External metal handrails become too hot or too cold in extremes of temperature, making them extremely difficult to grasp safely and securely.

**6.3.9**

All unenclosed floor openings, and open sides of landings, balconies, accessible roofs or porches shall be protected by guardrails which shall not be less than 3'-6" in height. This requirement does not apply to the loading side of loading docks. The height of the guardrail may be lowered in the following conditions. Where guardrails are required within individual dwelling units, the height of the guardrail may be 3'-0". The guardrail on a balcony immediately in front of the first row of fixed seats and which are not at the end of an aisle may be 2'-2" in height.

**6.3.10**

Handrails and guardrails shall be designed so that the area in the plane of the handrail or guardrail, from the top of the tread or floor surface to the underside of the rail, shall be filled with balusters, intermediate rails, ornamental closures or panels which shall not allow the passage of a sphere exceeding 5" in diameter except any triangular opening formed by a tread, riser and bottom edge of a continuous rail, if that bottom edge is no more than 2" above the nosing. See Figure 6.3.10. In areas of commercial or industrial type occupancies which are not open to visitors or children the open space between intermediate rails may be increased such that a sphere of 10" in diameter cannot pass through, and the open space between balusters may be increased such that a sphere of 6" in diameter cannot pass through.

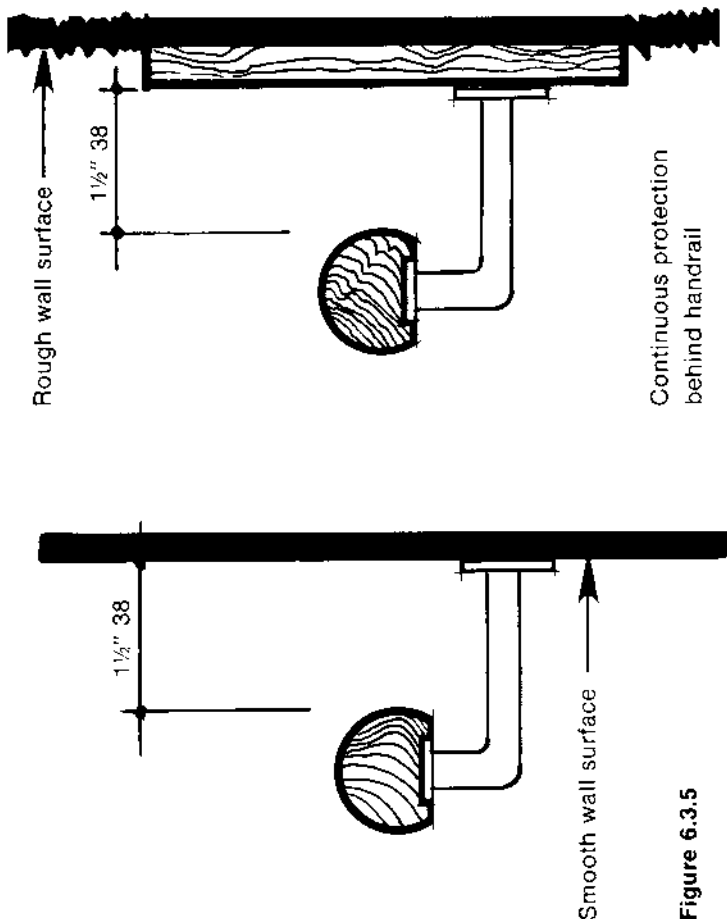


Figure 6.3.5

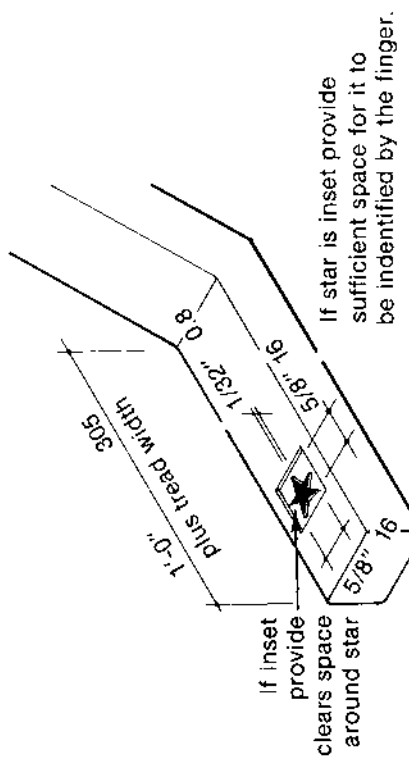


Figure 6.3.7  
Indication to blind of main exit floor.

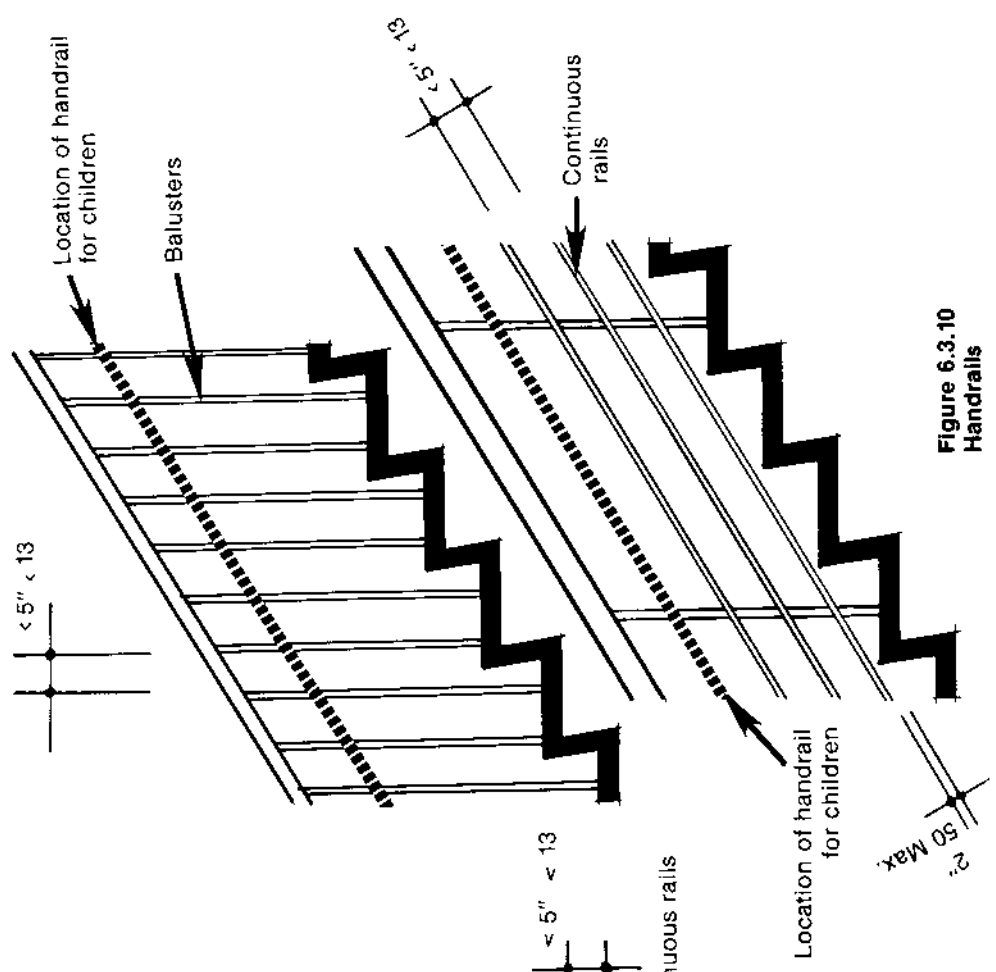


Figure 6.3.10  
Handrails

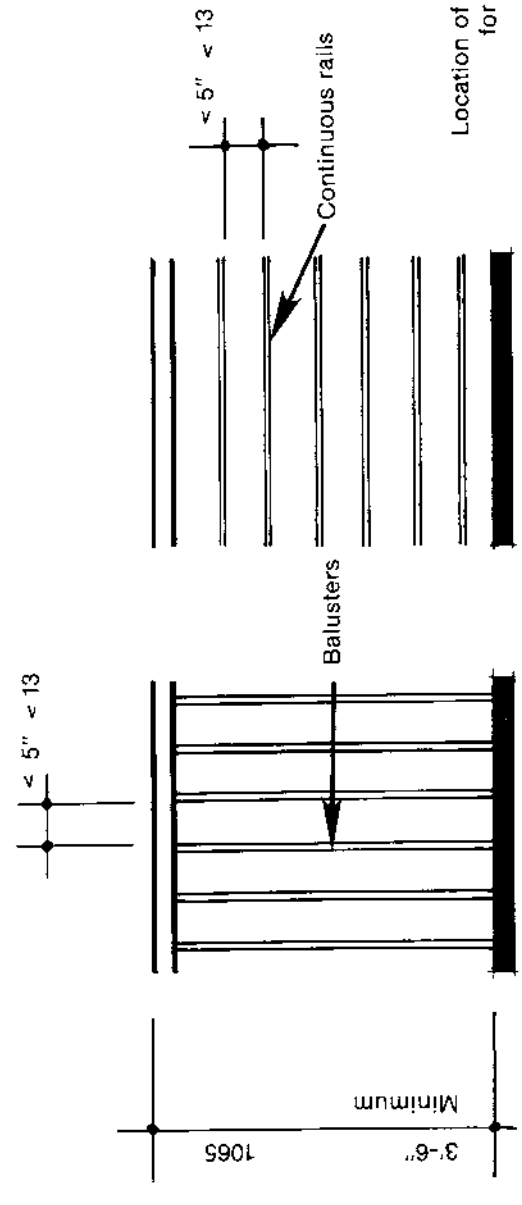


Figure 6.3.10  
Guardrails

There are often no elevators in low-rise buildings to provide vertical transportation of persons in wheelchairs and those unable to climb stairs.

## 7.1

### ELEVATORS

All passenger elevators and elevator lobbies shall be accessible. Elevators shall comply with the American National Safety Code for Elevators, Dumbwaiters, Escalators and Moving Walks, ANSI A17.1 —1971.

Because of complicated building layouts and internal circulation routes in some buildings, it may be difficult or confusing for some people to find the elevator lobby.

## 7.1.1

Elevator lobbies shall be located adjacent to direct and accessible paths of travel from the entrance and all major areas of the building. Directional signs shall be provided when the elevator location is not obvious, see Section 12.1, Signage.

Call and floor buttons in the elevator lobby and elevator car are sometimes obstructed by large ashtrays, preventing side approach for those in wheelchairs.

## 7.1.2

No rigid, hard object shall project into the elevator lobby space unless the dimension from the bottom edge of the object to the floor surface is at least 7'-6". Below this height, protruding objects which project more than 4" from a wall or column must:

- a. continue to the floor; or
- b. to within 8" of the floor; or
- c. be located in protected areas which are recessed or enclosed by wing walls. Such a protected area shall have a contrasting floor texture and color.
- d. Doors and door closers do not have to conform to this requirement.

If the joints between brick or quarry tile paving in lobbies are not flush with the adjacent surfaces, it can be painful or difficult to wheel over them, and spasticity may result. Recessed joints can trip people with a drop foot, stiff leg or leg prosthesis.

## 7.1.3

The floor surface of the lobby shall meet the requirements of Section 13.1, Ground and Floor Surfaces, to provide a surface that provides easy maneuverability for those in wheelchairs.

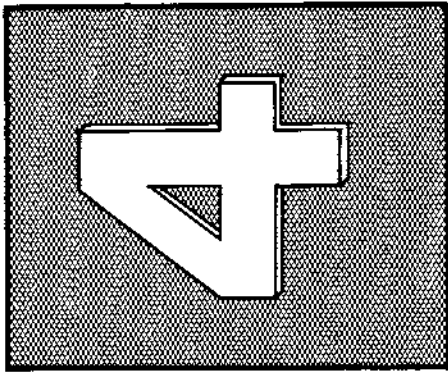
Thick carpets or carpets on underlay make it difficult for persons to roll their wheelchairs. In elevator lobbies, this creates problems by increasing the time required to get to the elevator doors.

Without a tactile character on the elevator door jamb or an audible cue, the blind cannot tell at which floor the elevator has arrived.

## 7.1.4

All elevator hoistway entrances shall have floor designations provided at each jamb. The centerline of these characters shall be located 5'-0" from the floor. The size of the characters shall be a minimum of 2" high and shall be raised at least  $\frac{1}{32}$ ". The character shall be of a contrasting color with the surface on which it is mounted, preferably a light color on a dark background. Permanently applied plates are acceptable.

Tactile arabic characters or numerals on the elevator door jamb can be used by blind and sighted people.



Character to be raised  
at least 1/32" 0.8  
and contrast in color  
to the background

Figure 7.1.4  
Floor designations on jambs

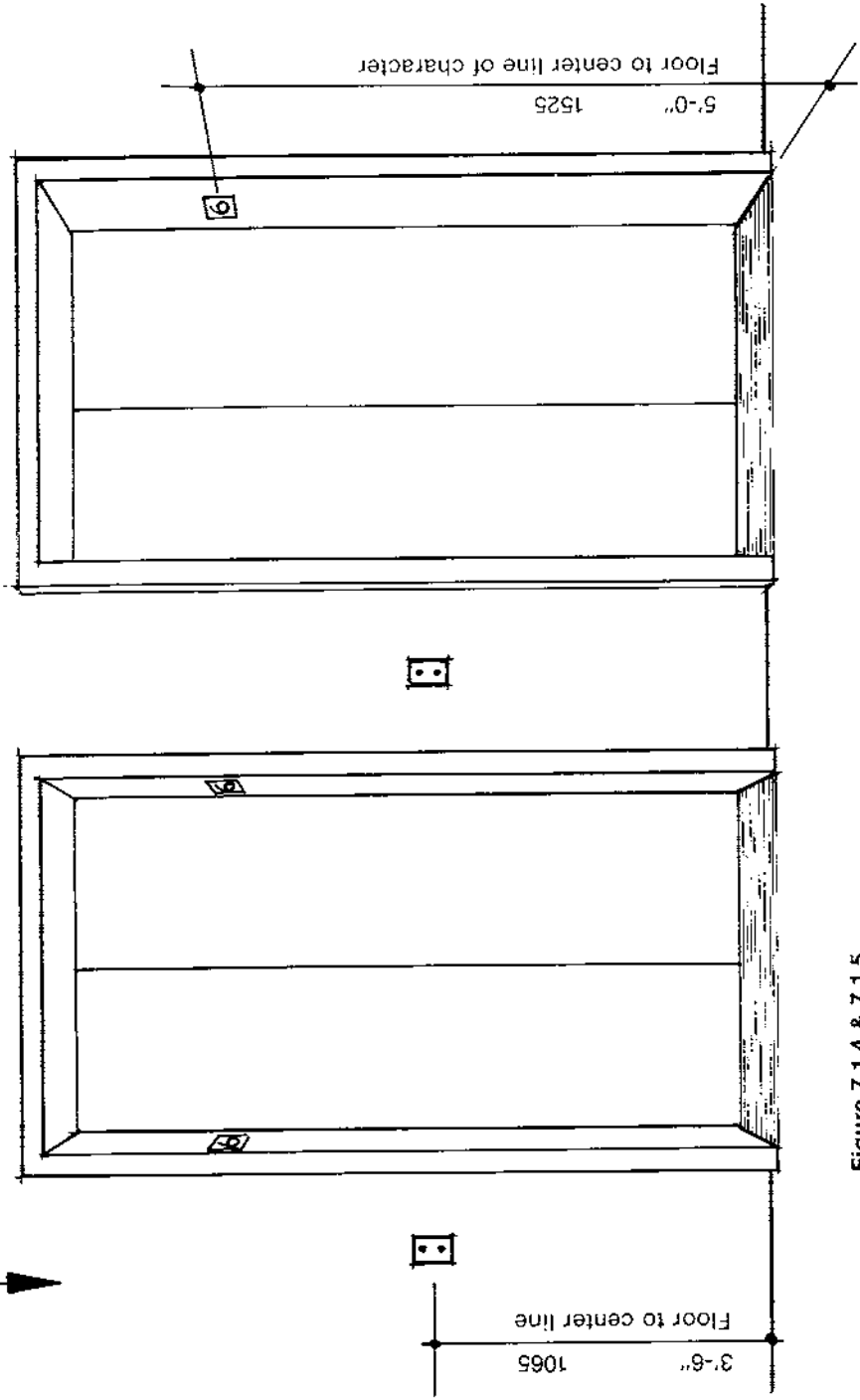
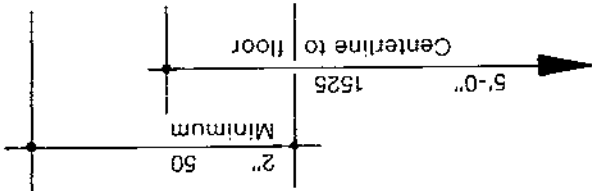


Figure 7.1.4 & 7.1.5  
Location of floor designations and call buttons in elevator lobbies



Because of the varying heights and positions of call buttons, the severely visually impaired find them difficult to locate. The problem is compounded when there is little color contrast between the button and the lobby wall finish.

### 7.1.5

All elevator lobbies shall have the call buttons located so that the centerline of the buttons is 3'-6" from the floor surface. Where only one call button is required, the mounting height shall be 3'-6" to the center of the button. Call buttons at the main entrance and transfer floors shall be identified by a sign indicating the floors served by such elevators. This sign shall have characters raised at least  $\frac{1}{32}$ " from the surface, have sharply defined edges, and shall be at least  $\frac{1}{2}$ " high. The characters shall be a contrasting color to the background, preferably a light color on a dark background.

When there is no warning of an approaching elevator, those with vision impairment, agility problems, those in wheelchairs or people carrying heavy luggage may not have sufficient time to reach the car before the doors close.

### 7.1.6

All hoistway entrances shall have visible and audible signals to indicate an approaching car and its direction of travel. The centerline of the visible signal shall be a minimum of 6'-0" from the lobby floor. Arrow shapes for directional indication to be consistent with the direction of travel of the elevators shall be used. Each symbol shall be  $2\frac{1}{2}$ " high. They shall be visible from the proximity of the lobby call buttons. The color white shall be used for the "up" symbol and red shall be used for the "down". Audible signals shall sound once for the "up" elevator and twice for the "down" elevator. The use of in-car lanterns are acceptable, and they shall be visible from the area in front of the call button.

If the audible signal for an approaching elevator is the same for the "up" and "down" direction, it is confusing for the blind, especially in lobbies with several elevators.

Elevator lobbies with hard surfaces increase the reverberation time of audible signals and background noise. This makes it difficult for the blind or hearing impaired to hear and locate the approaching elevator.

### 7.1.7

The minimum acceptable time from visual and audible notification that a car is answering a call until the doors of that car start to close shall be calculated from the following equation:

$$T = \frac{D}{1.5 \text{ ft./sec.}}$$

Where T = total time in seconds

D = distance in feet from a point in the center of the lobby or corridor (maximum 5'-0") directly in front of the furthest call button to the centerline of the hoistway door.

For cars with in-car lanterns, T begins when the lantern is visible.

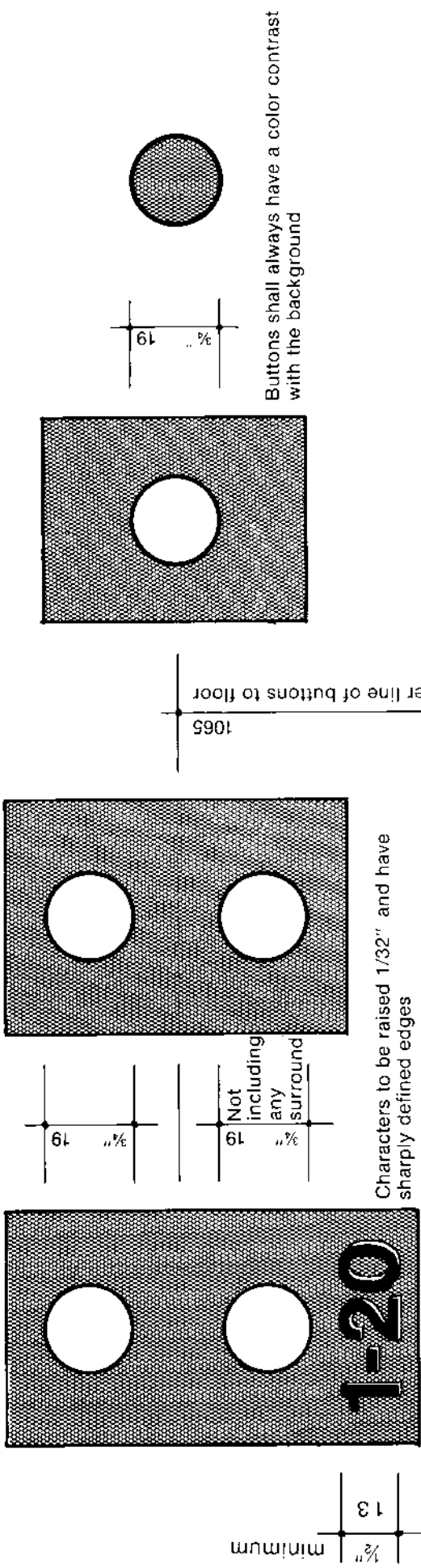


Figure 7.1.5  
Call buttons in elevator lobbies

Call buttons at main entrance and transfer floors for zoned elevators shall have identification of floors served.

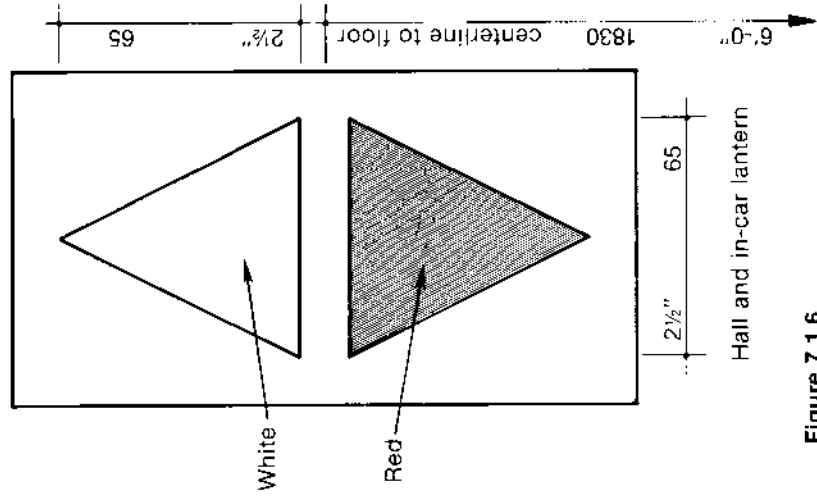


Figure 7.1.6  
Visible signal for approaching car

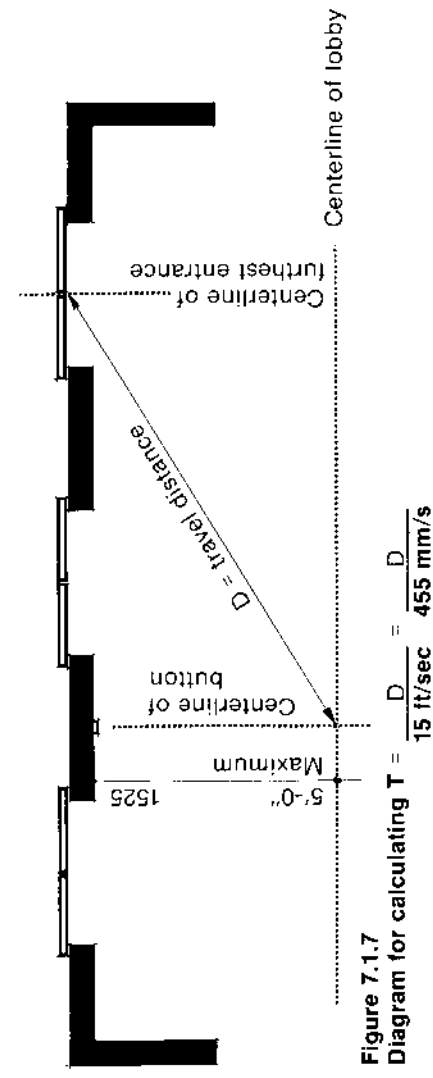


Figure 7.1.7  
Diagram for calculating T

**7.1.8**

The minimum time in response to car calls for elevator doors to remain fully open shall be 3 seconds. Door reopening devices shall remain effective for a period of at least 20 seconds. After this time, doors may close in accordance with ANSI Safety Code for Elevators, Dumbwaiters, Escalators and Moving Walks—A17.1—1971.

If the floor of the elevator car is not level with the lobby floor, a hazard occurs which may cause trips and prevent ingress and egress of wheelchairs.

**7.1.9**

The elevator operation shall be automatic and each car shall be provided with a self-leveling feature which will automatically bring the car to the floor landings within a tolerance of  $\pm \frac{1}{2}$ " under rated loading to zero loading conditions. This self-leveling feature shall, within its zone, be entirely automatic and independent of the operating device, and shall correct for overtravel or undertravel.

Some elevator doors are too narrow to admit a wheelchair.

**7.1.10**

The minimum clear door width shall be as specified in Table 7.1.12, Standard Sizes of Accessible Elevator Cars.

When elevator doors close too quickly, it can be hazardous and frightening for people who move slowly. Some elevator doors with a sensitive leading edge close with a force sufficient to knock a person down, especially if the person has balance and agility problems.

**7.1.11**

Elevator doors shall open and close by automatic means. They shall be provided with a reopening device which will stop and reopen a car door and adjacent hoistway door automatically if the door is obstructed by an object or person while closing. The reopening device shall be capable of completing these operations without requiring contact for operation if the object or person passes through sensing devices located at a height of 5" and 2'-5" from the floor, as shown in Figure 7.1.11.

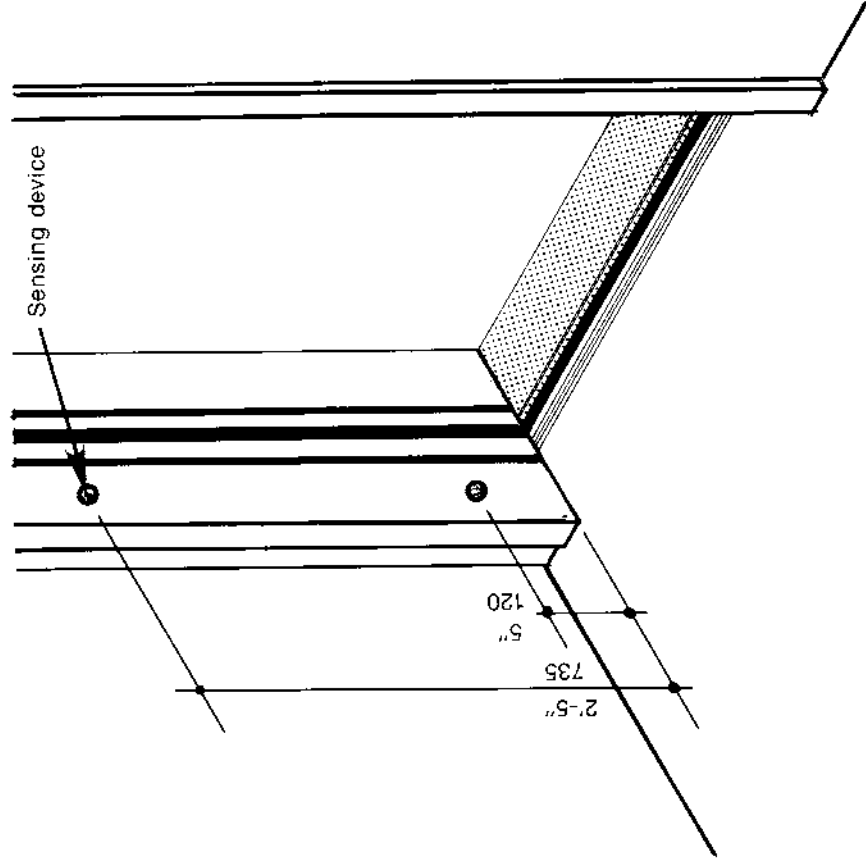


Figure 7.1.11  
Positions of door opening sensing devices

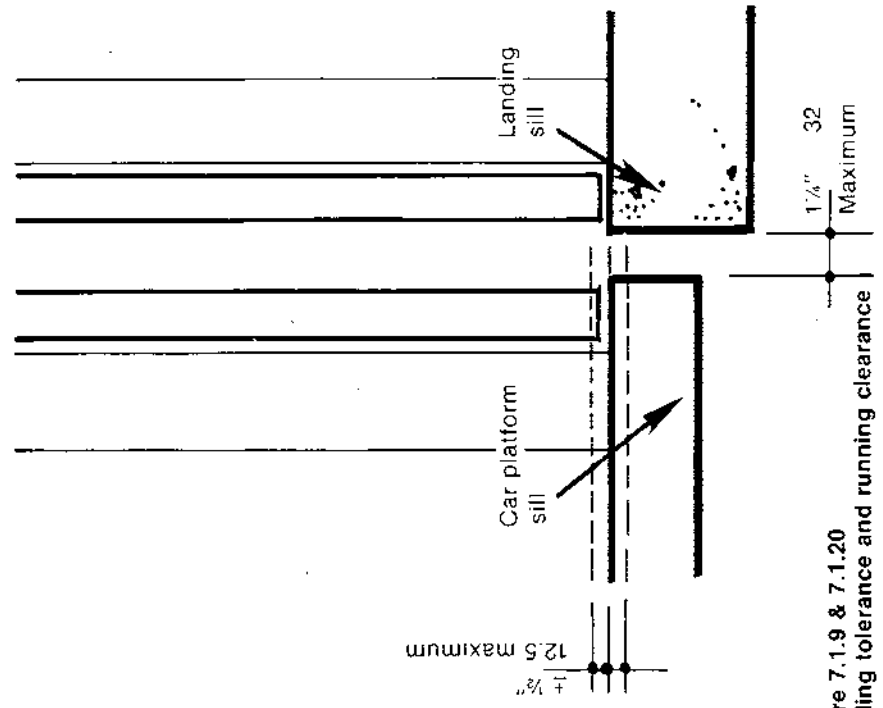


Figure 7.1.19 & 7.1.20  
Landing tolerance and running clearance

Elevator cars which are too small to turn a wheelchair make it:

- a. difficult to know when the required floor has been reached because the floor position indicator cannot be seen.
- b. difficult to back the wheelchair out if the elevator is crowded.
- c. difficult to press buttons on the door wall if the person cannot turn his body or raise and bend his arm to reach the control panel.

Elevators large enough to carry only one or two persons in wheelchairs are inconvenient if several people in wheelchairs require simultaneous transportation. This situation sometimes occurs in hotels, when all elevators do not serve meeting-room floors or restaurants.

**7.1.12** The floor plan of elevator cars shall allow people in wheelchairs to enter and leave the car, and space to maneuver to reach the controls. The minimum acceptable inside dimensions of cars of standard sizes are shown in Figure 7.1.12 and Table 7.1.12.

**TABLE 7.1.12**  
**Standard Sizes of Accessible Elevator Cars**

Capacity Lbs.	Width w	Depth d	Side Opening	Clear Door Width Center Opening
1500*	4'-6"	4'-3"	2'-8"	—
2000**	5'-8"	4'-3"	3'-0"	—
2500	6'-8"	4'-3"	3'-6"***	3'-6"
3000	6'-8"	4'-7"	3'-6"***	3'-6"
3500	6'-8"	5'-3"	3'-6"***	3'-6"
4000	7'-8"	5'-3"	—	4'-0"***

\*Does not permit a wheelchair to turn around, and shall only be used in existing buildings.

\*\*Does not permit a wheelchair to turn around.

\*\*\*Accommodates a 6'-0" x 2'-0" stretcher in the horizontal position

It is often difficult to get a person on a stretcher into an elevator without tilting the stretcher. This procedure may endanger that person's life.

**7.1.13** In buildings over three stories, one elevator shall be installed with the capability of carrying an ambulance stretcher of 6'-0" x 2'-0" without tilting it to gain access.

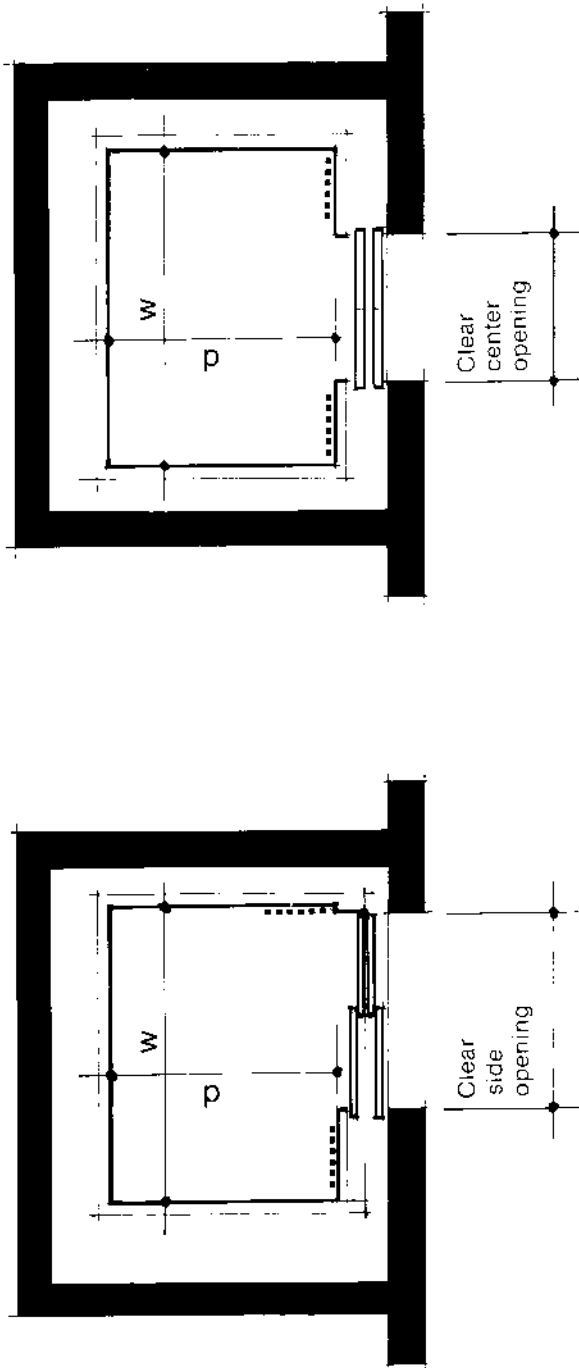


Figure 7.1.12  
Elevator car-inside dimensions and possible control panel locations

There is no uniformity in position or layout of elevator control panels and buttons. This can cause confusion for most people, especially the visually impaired, the elderly, and the mentally retarded.

Recessed buttons are difficult to operate by upper limb amputees, with or without artificial limbs.

"Touch" buttons are a problem for the visually impaired or uncoordinated person. Several buttons are activated in the attempt to push the one required. Also, it is impossible to know if the button has been activated unless the person has vision and can see the light around it.

In buildings with mezzanines, various lobbies, basement garages, etc., it is difficult to know which button to press for the street level when it is not clearly indicated.

Emergency buttons and telephones are often placed too high in the elevator car to be reached by persons in wheelchairs, children and short people, denying them the means to call for help.

#### 7.1.14

The location of elevator controls shall comply with the requirements illustrated in Figure 7.1.14 and be readily accessible from a wheelchair upon entering an elevator. Raised characters shall be  $\frac{1}{2}$ " high and raised  $\frac{1}{32}$ " from the surface, have sharply defined edges, and contrast in color with the face plate. Permanently applied plates are acceptable. Raised characters shall be to the left of the buttons. Emergency controls shall be grouped at the bottom of the control panel and be 2'-1" from the floor level to the center of the emergency button. The highest floor buttons shall be no higher than 4'-6" from the floor level to the center of the buttons. When two rows of buttons are required, odd numbers shall occur on the left hand side and even numbers on the right hand side. Where three rows are necessary, the buttons shall be numbered from the bottom, left to right, as shown in Fig. 7.1.14. A blank button shall be required for floor 13, when that floor identification does not occur in the building (for superstitious reasons). Raised buttons are preferred, but recessed buttons are acceptable providing the recess does not exceed  $\frac{1}{4}$ ". The minimum size of the button shall be  $\frac{3}{4}$ ", not including any lighting around the button. Visual indication shall be provided to show each call registered and extinguished when that floor is reached. Standard symbols shall be used to designate essential controls and shall be as shown in Figure 4.1.14.

It is sometimes difficult to know when the elevator has reached the desired floor, especially if the:

- a. floor position indicator is too small to be read; or
- b. floor position indicator is not illuminated sufficiently well.

If there is no handrail to grasp in the elevator car, the acceleration or deceleration forces can cause some people to fall or feel insecure. Those affected include people with low stamina, agility, poor balance, incoordination and those susceptible to fainting and dizziness.

#### 7.1.15

A car position indicator shall be provided above the car control panel or over the opening in each car to show the position of the elevator in the hoistway. As the car passes or stops at floors served by the elevator, the corresponding numeral shall illuminate and an audible signal shall sound. Numerals shall be a minimum of  $\frac{1}{2}$ " high. The audible signal shall be no less than 20 dB. An automatic verbal announcement of the floor number at which the car stops may be substituted for the above audible signal, and is preferred.

#### 7.1.16

Handrails shall be provided on the side walls of the car, and preferably on the side and rear walls, mounted at a height of 2'-6" to 2'-8" from the floor of the car. The rail shall have  $1\frac{1}{2}$ " clearance between the wall and the rail. See Section 6.3 for handrail selection.

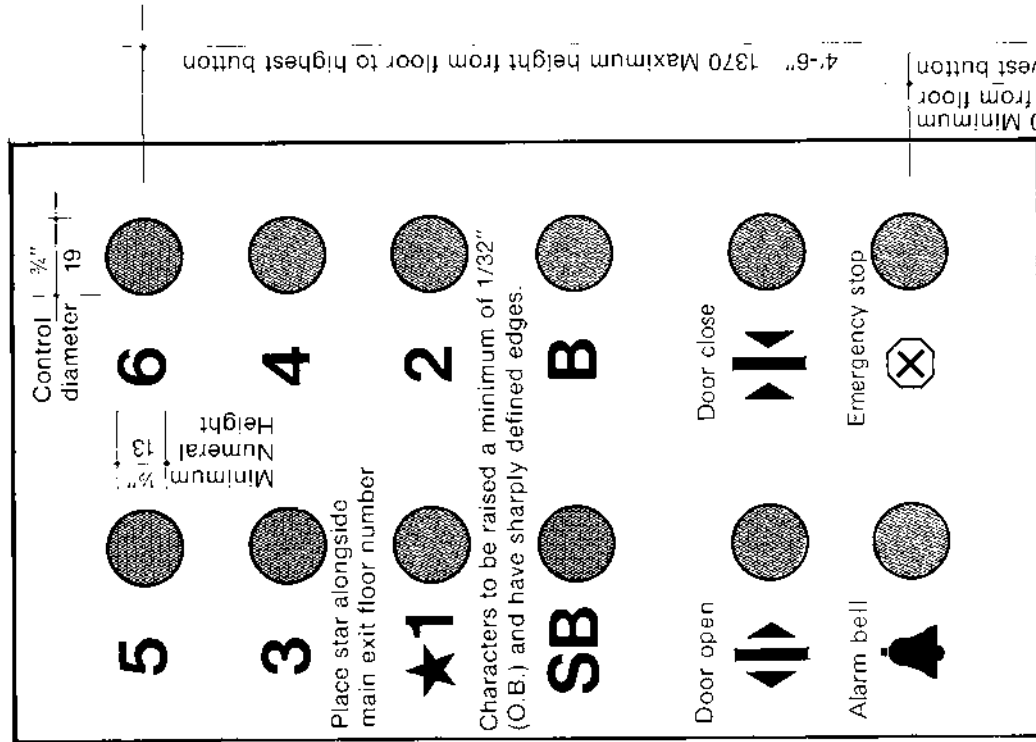


Figure 7.1.14 B  
Elevator control panel

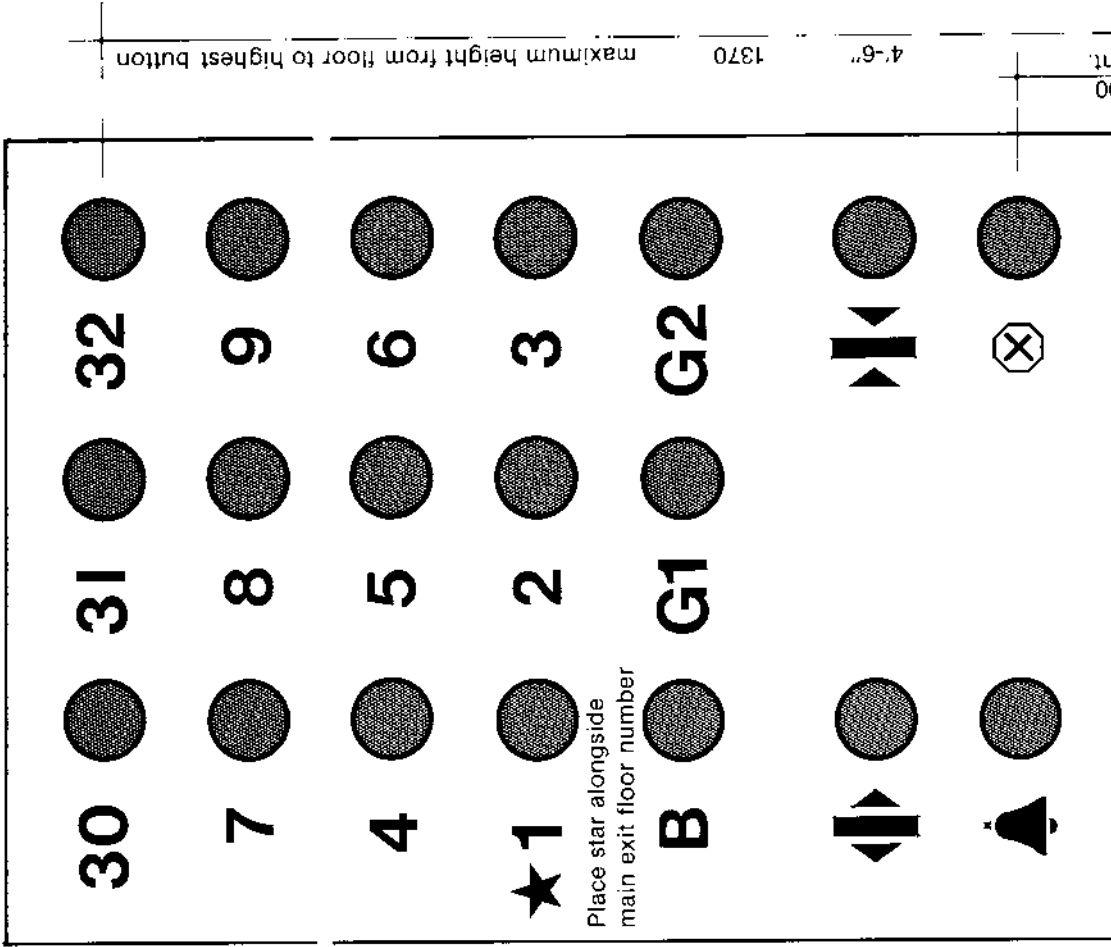


Figure 7.1.14 C

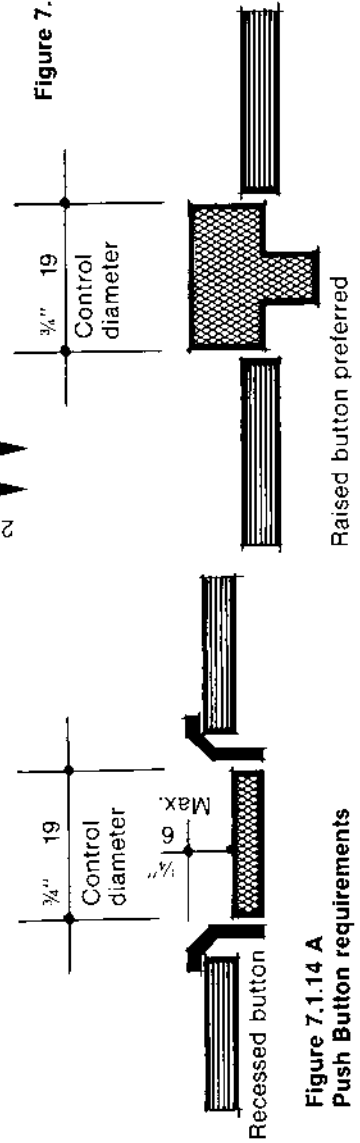


Figure 7.1.14 A  
Push Button requirements



Not all amputees, quadriplegics and those with incoordination can use a pay telephone. For many others, the telephone can only be used with difficulty.

When trapped in a stalled elevator, the deaf cannot hear if the alarm bell is ringing, or if their telephonic call has been received and answered. This is very traumatic for some people.

#### **7.1.17**

An emergency two-way communication system between the elevator and a point outside the hoistway shall be provided. If the system is normally connected to the building power supply, it shall automatically transfer to a source of emergency power within 10 seconds of the failure of normal power supply. The emergency power source shall be capable of providing two-way communication for at least 4 hours. The highest operable part of a two-way communication system shall be a maximum of 4'-0" from the floor of the cab. The location of the communication system shall be identified with a raised symbol adjacent to the device. A system without handset is preferred. A light shall also be provided to signal to any deaf person who may be trapped in an elevator when his emergency call has been answered.

People can be injured if they fall in an elevator and hit themselves on sharp corners.

#### **7.1.18**

There shall be no sharp edges or rough surfaces in the elevator car or hoistway opening.

It is difficult to maneuver a wheelchair over floors which have carpet on underlay or carpet with thick pile.

#### **7.1.19**

The floor finish shall be slip resistant, see Section 13.1, Ground and Floor Surfaces. When carpet is used in the car, it shall be laid without underlay, securely attached to the floor and have a tight weave and low pile. Uncut pile is preferred.

Some elevator cars have slippery floor surfaces.

Sometimes the gap between the elevator car and the lobby floor is too wide, creating a hazard. The gap may trip some people, catch the caster wheels of wheelchairs, and white canes of the blind.

#### **7.1.20**

The gap between the threshold of the elevator car and the lobby floor (running clearance) shall be no wider than 1¾".

The lighting level in some elevator lobbies is too low to identify the number on the buttons or to read information.

#### **7.1.21**

The minimum illumination at the car controls, car threshold and landing sill shall be at least 5 footcandles.

In high-rise buildings, the elevator is the only means of ready egress for the non-ambulatory in the case of fire, but these are called to the ground floor when the fire alarm is activated, and persons in wheelchairs or others who cannot use stairs can be trapped in the building.

#### **7.1.22**

Where remodeling is taking place, and an existing elevator will not permit a wheelchair to turn, the control panel shall be relocated on the side wall, and not in the door wall. A mirror shall be placed on the wall opposite the door, so the floor position indicator will be reflected and be visible to a person sitting in a wheelchair, or a second floor position indicator shall be installed in the rear wall.



Because there are few public restroom facilities, many persons who are incontinent only travel familiar routes or short distances from their homes. This is also a problem for people accompanying small children.

Stops located at the entrance or on the circulation route to restrooms make them inaccessible to those in wheelchairs and others who have problems using stairs.

Restrooms located off narrow corridors or halls prevent people in wheelchairs from maneuvering through the door.

The location of toilets is frequently obscure or located away from major circulation routes, which increases the problems for those with low stamina, agility, balance or incoordination, and those people who have to push their wheelchairs over long distances. The lack of directional signs increases the difficulty in locating these facilities.

The signs MEN and WOMEN on toilet room doors are often too small to be read. Where symbols are used, they are often insufficiently different to be distinguishable by people with low vision, or those who are mentally retarded.

The blind frequently cannot locate toilets, or distinguish whether they are for men or women because of the lack of braille or raised arabic characters on the door.

Mentally retarded people who are taught to distinguish public toilet facilities by noticing the length of the word, MEN or WOMEN, are confused by GENTLEMEN-LADIES, KINGS-QUEENS, etc.

## 8.1

### PUBLIC TOILET ROOMS

Buildings required by code to have toilet facilities shall have accessible and usable toilets and related fixtures for use by disabled people. Design and location of personal hygiene facilities shall provide the same conditions and privacy for all users. Each public toilet room shall have one accessible water closet and related facilities.

#### 8.1.1

Toilets shall be located adjacent to accessible circulation paths and comply with the requirement of Section 5.1, Interior Circulation Routes. Visual and tactile directions shall be given in circulation areas, and comply with the requirements of Section 12.1, Communication and Identification.

#### 8.1.2

The symbol and/or name on the toilet room door shall be raised at least  $\frac{1}{32}$ " from the surface. The characters shall be at least  $2\frac{1}{2}$ " high and shall be mounted 4'-6" to 5'-0" from the floor surface. The symbol or character shall be in a contrasting color from the background, see Section 12.1.4, Communication and Identification.



Restroom doors, located at the end of short corridors and without eighteen inches of clearance on the handle side of the door, are extremely difficult to open for people in wheelchairs, as they have to lean forward to reach the handle, propel the chair backwards as the door opens and then wheel through the open door. This is a very difficult maneuver to do without trunk balance, especially if the person is not strong in the arms.

It is difficult for children, people in wheelchairs, the elderly, those with reduced stamina, agility, balance and incoordination to open heavy toilet room doors.

Many toilet room doors are too narrow for wheelchair access.

Paneled toilet room doors can catch wheelchair footrests, drive rims, or other parts of the frame, making passage through the door difficult.

Thresholds or changes in level between the corridor floor surface and toilet floor surface may restrict the movement of wheelchair casters, wheels, and may create a tripping hazard for those with lower limb impairment or problems of balance and agility.

Inadequate space adjacent toilet room doors, especially when doors are in series, does not allow room for people to avoid being hit by the door swing.



A toilet stall built to ANSI A117.1 (71) dimensions or 3'-0" wide by 4'-8" deep may still be inaccessible if the door location is in the side.

Photo: Peter Wachter

Often "modesty barriers" prevent access to the toilet room to those in wheelchairs because they create short, narrow corridors that are impossible or difficult to maneuver. Doors in series are often situated too close together, so that a person in a wheelchair cannot back when opening the second door as the first has closed behind him. The toilet is then only accessible with help. This situation denies freedom of access to people who are otherwise independent.

### 8.1.3

Toilet room doors shall have a minimum clear width of 2'-8", smooth surfaces, preferably no threshold, and at least 1'-6" clearance at the handle side of the door for wheelchair maneuvering, see Section 4.1, Entrances, Doors and Doorways. Where door vents are required, they shall be located so that they will not interfere with the drive rim or footrests of wheelchairs, see Section 2.3.1, Dimensions of Wheelchairs. Door Handles shall meet the requirements of Section 4.2, Door Handles.

### 8.1.4

Where there is a passage way from the corridor/toilet entrance to the toilet room, for modesty purposes, the dimensions and configurations shall meet the requirements of Section 2.3.2, Space Requirements for Maneuvering Wheelchairs, and Figure 8.1.4. There shall be no abrupt change in level between the toilet room floor and corridor floor, or within any part of the toilet room. Thresholds shall be bevelled to allow wheelchair access, see Section 4.1.10, Entrances, Doors and Doorways.

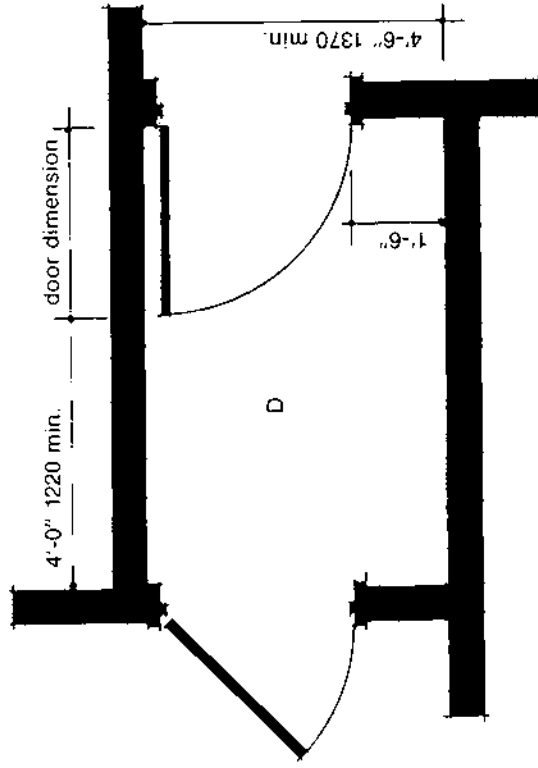
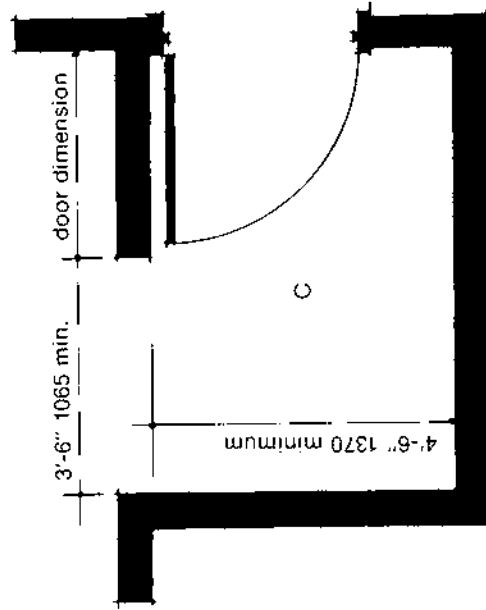
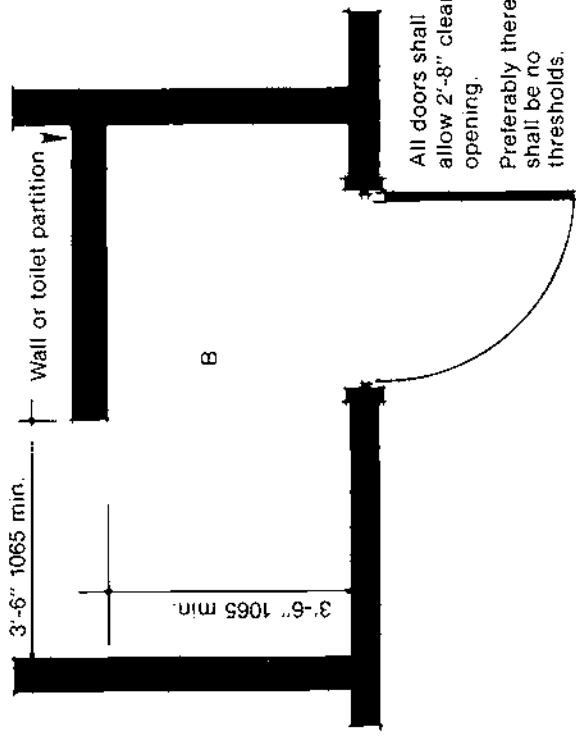
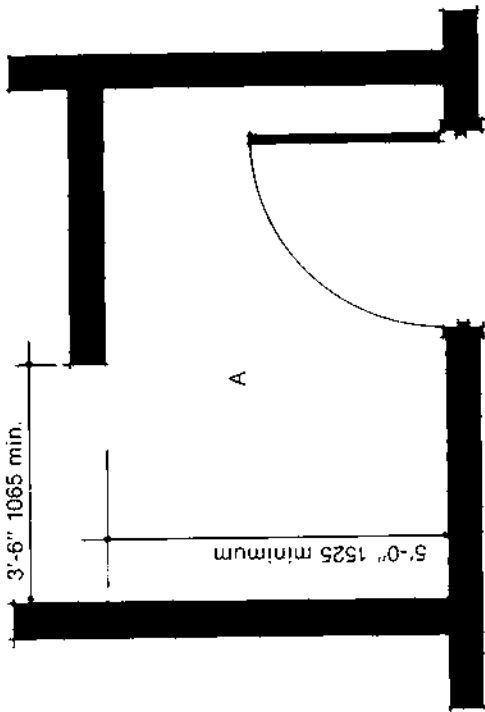


Figure 8.1.4  
Examples of circulation requirements alongside  
modesty screens.

Toilet room floor finishes are sometimes too slippery for those with balance problems or who use walking aids, especially when water is splashed on them.

#### **8.1.5**

The toilet room floor finish shall be slip resistant, particularly when wet. See Section 13.1, Ground and Floor Surfaces.

#### **8.1.6**

Where the required number of fixtures, as established by the 1976 Illinois State Plumbing Code, indicates that a single, individual toilet room is adequate, that toilet room shall comply with all the requirements for accessibility under Section 8.1, Public Toilet Rooms.

Toilet stalls with doors opening inwards cannot be closed by persons in wheelchairs because their chair is in the way, thus denying them privacy.

Locking devices on toilet stall doors often require grasping, pinching, or turning of the wrist to operate them. This is difficult or impossible for those with upper limb, wrist or finger problems.

Curtains replacing doors on toilet stalls, to make them accessible, do not offer the same degree of privacy guaranteed to the able-bodied.

Most people in wheelchairs cannot transfer forward from their chair onto the watercloset and need space for side transfer.

Some makeshift grab-bars will not adequately support a person making a transfer from a wheelchair to a watercloset.

If the space between the grab-bar and the wall exceeds  $1\frac{1}{2}$ " , a person's arm may slip down during the transfer sequence. It is possible to break an arm if a person slips and falls during the transfer sequence.

Waterclosets are often too high to permit convenient transfer from a wheelchair.

Many disabled people rely on the toilet seat cover or the toilet tank for bodily support when defecating. The reason for this is lack of trunk balance.

Flushing devices are often too low for people who have difficulty in bending.

Some flushing devices require too much effort to operate. Foot operated flushing devices cannot be used by people in wheelchairs.

#### **8.1.7**

At least one toilet stall in every toilet room, including employee facilities, shall be usable by people in wheelchairs or who use walking aids. The accessible toilet stall shall have a minimum of 5'-0" x 5'-0" clear internal dimensions. The door shall swing out and have a 2'-8" clear opening. Opening and locking devices shall not require a pinching or twisting of the wrist to operate. Toilet stalls of minimum size shall have wall mounted water closets. Floor mounted water closets are acceptable if the depth of the stall is increased to 6'-0". Water closets shall be located 1'-6" from the right or left hand partition to the center line of the fixture. Flushing mechanisms shall be automatic or operable without extremes of bending, reaching or twisting, and shall be activated by a non-precise movement requiring a light pressure. Such toilets shall have grab bars that comply with Fig. 8.1.7A and 8.1.7B. Grab bars shall meet the requirements of Section 14.2, Supports. The height of the toilet seat shall be 1'-5" to 1'-7", measured from the floor to the top of the toilet seat. Accessible toilets shall have toilet seats with covers. Maneuvering space in front of toilet stall door shall be a minimum of 3'-6" in width. Wall and ceiling hung partitions are preferred to floor mounted partitions. See Figure 8.1.7C

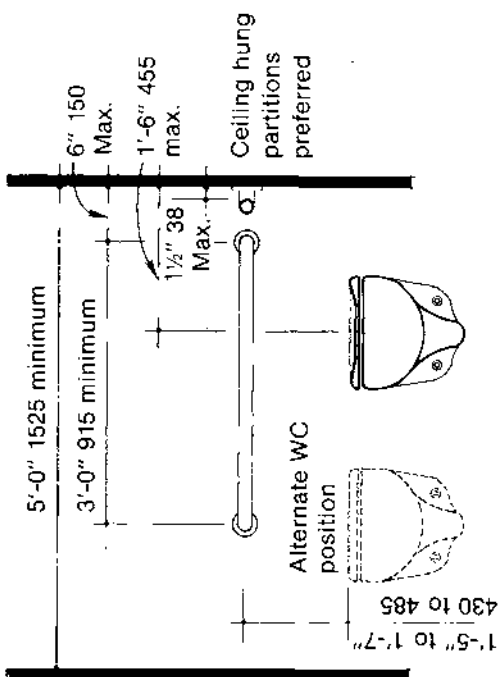


Figure 8.1.7 C  
 Accessible toilet stall

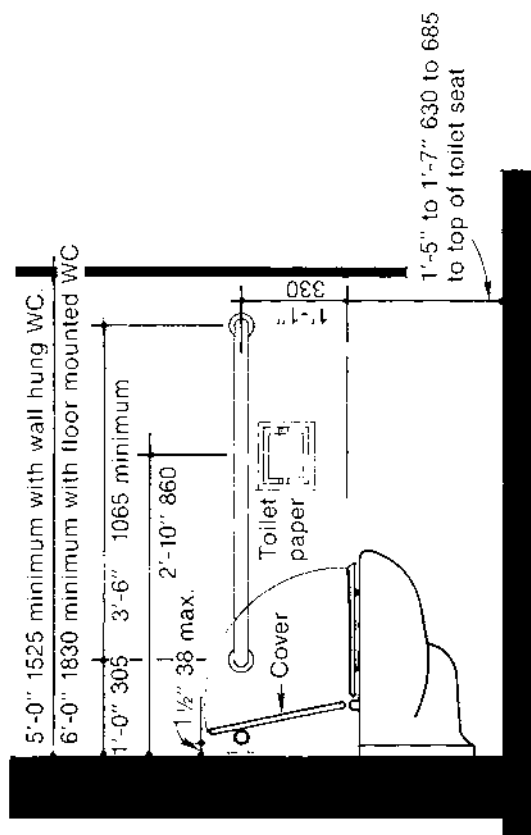


Figure 8.1.7 B  
 Accessible toilet stall

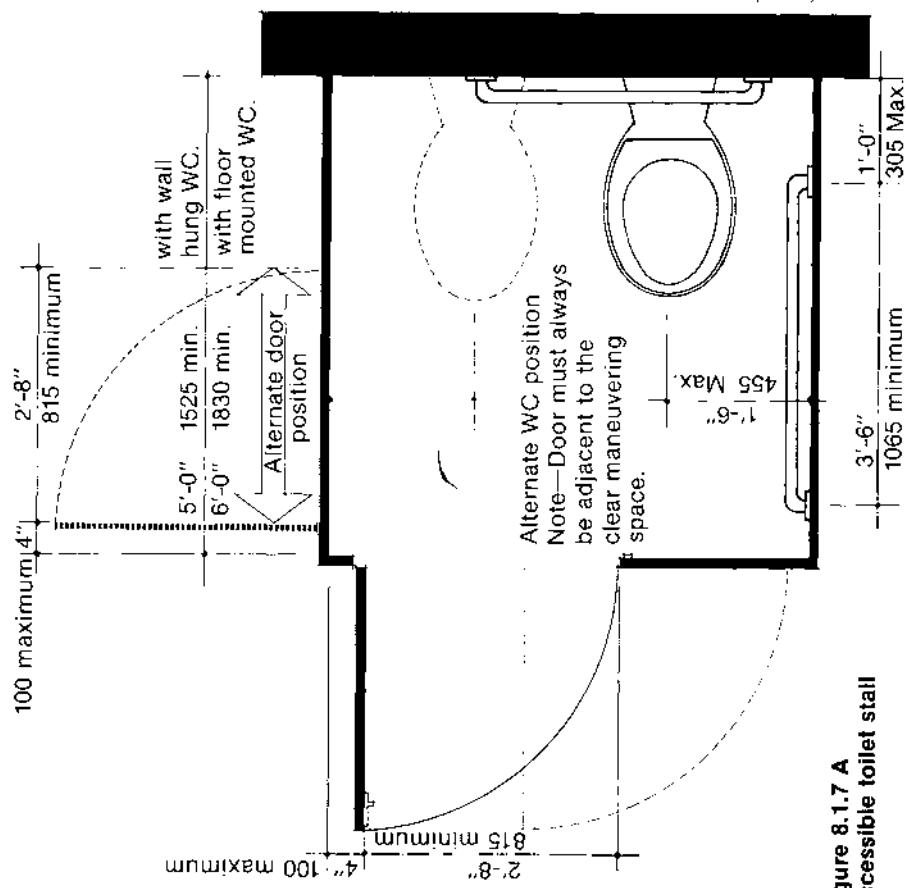
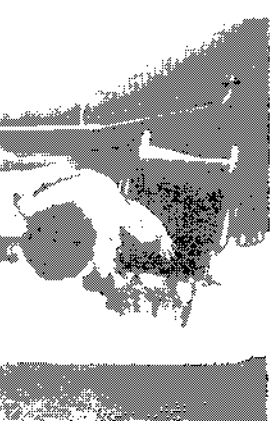
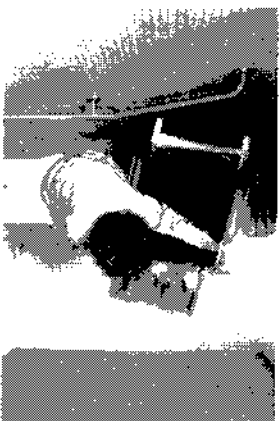
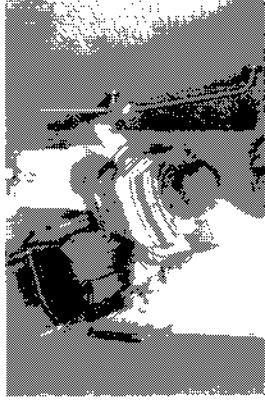


Figure 8.1.7 A  
 Accessible toilet stall





Right hand transfer sequence in a 5'-0" x 5'-0" stall. The whole area is used for the task of entering, positioning and transferring onto the water closet. The chair does not have to be collapsed to allow sufficient room to sit properly on the water closet. The open front of the seat may catch the clothes of the person during the transfer and hinder her progress.



Left hand toilet transfer sequence in a 5'-0" x 5'-0" stall. (The grab bar should continue parallel with the floor and not bend up as shown.) It must be remembered that people who are paralyzed have no trunk balance. Each leg has to be lifted off the foot rests before transfer can begin. The last photograph shows the arm wedged between the wall and the grab bar for safety. This space shall be 1½" wide.

A cover is required to support the person on the toilet. The flush valve does not provide this support.

Toilet roll holders situated so that they can be reached only by turning or twisting are difficult to use.

#### **8.1.8**

Tissue dispensers shall be placed 2'-10" to the center from the rear wall on the side wall closest to the toilet bowl, and shall be mounted immediately below the grab bar.

Restroom space is often too small to maneuver a wheelchair to and from the toilet stall, lavatory and towel dispenser. Small toilet rooms present difficulties for persons with balance problems because they can get bumped by others using the toilet facilities, or by the door as it is pushed open.

#### **8.1.9**

Space planning of toilet rooms shall allow front approach to all lavatories, see Section 2.3.2. Space Requirements for Maneuvering Wheelchair. Clearance under all lavatories shall be 2'-6" minimum from the floor to the underside of the apron, and 2'-10" maximum to the top of the lavatory bowl, see Figure 8.1.9. Exposed hot-water pipe and drain shall be fully insulated if the water temperatures exceed 105° F. Under-surfaces of lavatories shall be smooth.

Exposed hot water and drain pipes on lavatories can burn the legs of people in wheelchairs when they wash their hands. Rough surfaces and sharp projections below lavatories can cause abrasions to those in wheelchairs. As they may not have any feeling in their lower limbs, they can be totally unaware that they have been burned or scratched. The healing period for paraplegics and quadriplegics is much longer than for most non-disabled people.

Faucets that can be used only by grasping and/or twisting of the wrist are impossible or difficult to use for those with arm, wrist or finger impairment.

#### **8.1.10**

Faucets shall have a lever, blade, or multi-arm type handle or other design that does not require grasping or twisting of the wrist as the only means of operation. Single lever controls are preferred. Forces needed to activate the faucets should be as small as possible and shall be no greater than 3 lbf. Spring-operated faucets are not acceptable unless they meet these requirements and have a delay feature which allows the water to run for at least 10 seconds after the hand is removed from the faucet.

Spring operated faucets, without a delay feature to keep the water running a few moments after the removal of the hand, cannot be used by those with little strength in the arm, wrist or fingers. Nor can they be used by paraplegics, who have to use one hand or arm to control trunk balance, or by upper limb amputee with only one arm.

If the water temperature cannot be controlled easily, burns may result.

#### **8.1.11**

The "hot" faucet shall always be on the left-hand side of the lavatory and the "cold" faucet shall be on the right-hand side. The temperature of the hot water shall be no greater than 105°F. at the faucet.

The hot water temperature often exceeds the safety limit of 105°F.

Toilet room fixtures such as urinals, dispensers, towel dispensers, etc., are often positioned too high to be convenient for those in wheelchairs, small people and children.

#### **8.1.12**

There shall be sufficient floor area in front of, and under, a wall-mounted urinal to allow a wheelchair approach to bring the front edge of the seat to the lip. At least one wall-mounted urinal shall have an elongated lip and be mounted 1'-3" to 1'-5" from the floor surface to the top of the lip. There shall be at least 1'-4" clear width to each side of the center line of the urinal to facilitate wheelchair approach.

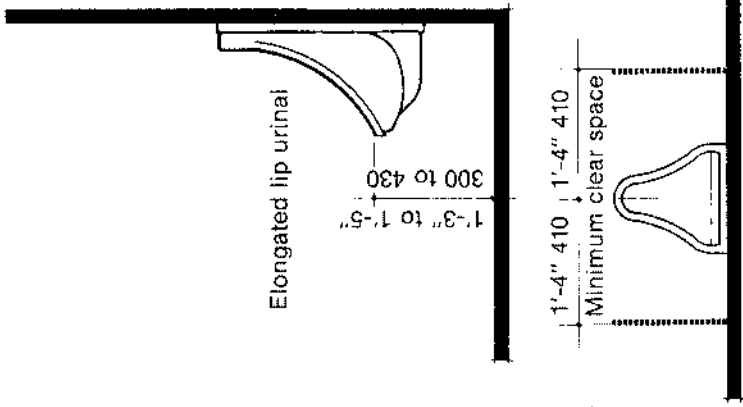


Figure 8.1.12  
Wall mounted urinal

If temperature of hot water exceeds 105°F the hot water line and drain shall be insulated to prevent burns.

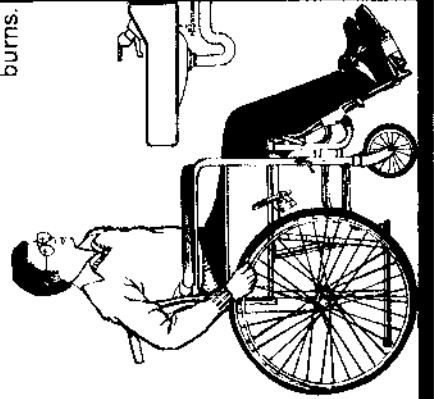
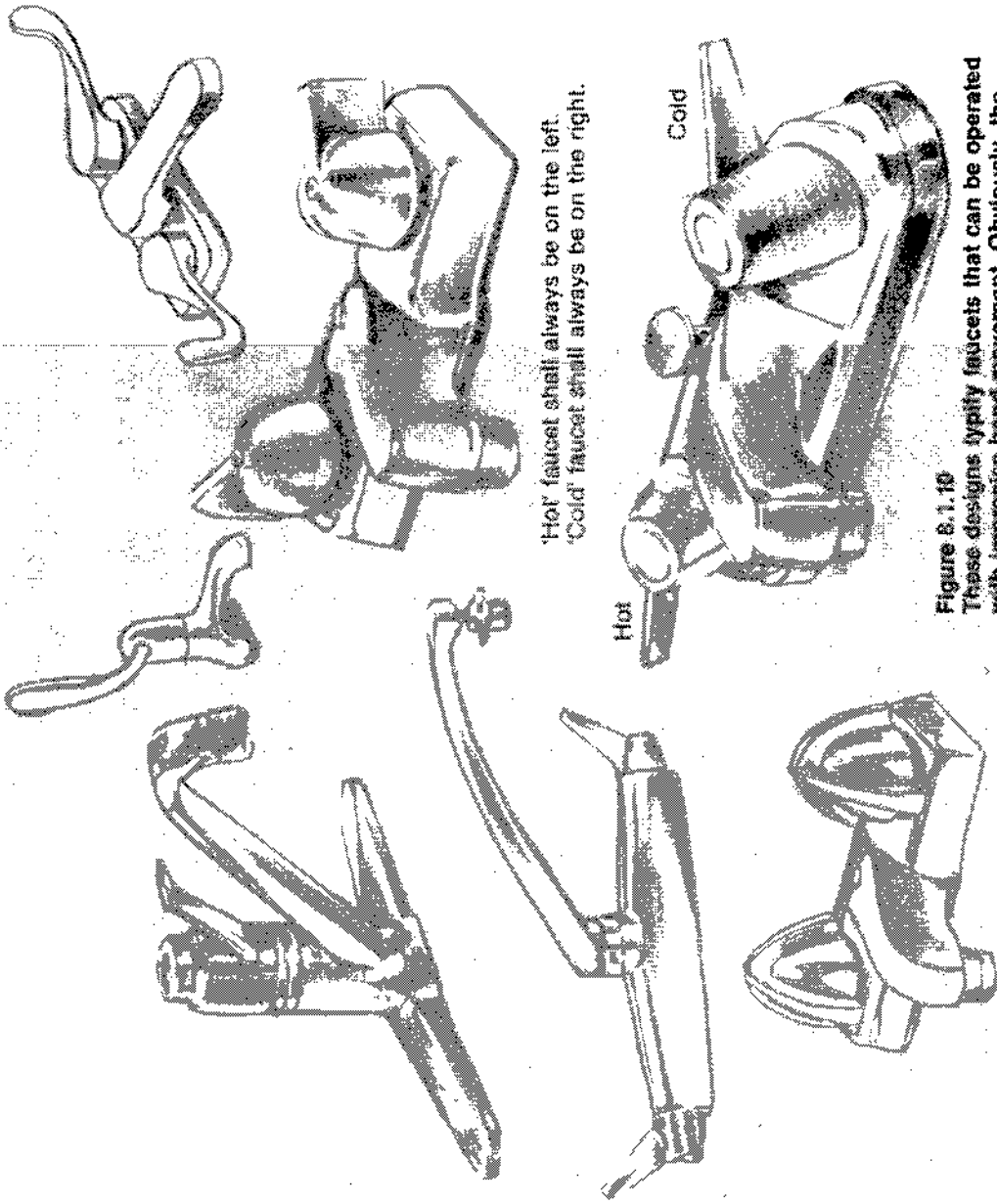


Figure 8.1.9  
Height requirements for lavatories



'Hot' faucet shall always be on the left.  
'Cold' faucet shall always be on the right.

Figure 8.1.10  
These designs typify faucets that can be operated with imprecise hand movement. Obviously, the more pronounced the blade, the easier will be the operation.

Short or seated people have difficulty using mirrors whose bottom edge is higher than 3'-4" above the floor.

#### **8.1.13**

All mirrors shall be mounted with the bottom edge no higher than 3'-2" from the floor surface.

Blind people bump into fixtures and devices that project into toilet room circulation space and are too high to be detected using the long cane technique.

#### **8.1.14**

Dispensers and receptacles shall be located so that they do not interfere with circulation, shall be free from hazards, rough surfaces or sharp edges and convenient to use. Dispensers and receptacles shall be mounted so that the highest operable part shall be no higher than 3'-4" above the floor surface.

Lack of uniformity in the location and height of fixtures make it difficult for the severely visually impaired to use toilet rooms conveniently.

If the towel dispenser is not adjacent to the lavatory, people moving between them will drip water onto the floor, which can result in a slippery surface.

Toilet room fixtures are often sharp-edged, which can cause undue injury for those who slip and fall, or who bump into them.

Persons with upper limb, wrist, hand or finger impairment often find dispensers and receptacles too difficult to use, e.g., small cranks on paper towel dispensers; paper towel dispensers where the paper towel does not protrude sufficiently to grasp; soap dispensers that require vertical pressure upwards to release soap; towel disposal units with spring loaded flaps; and feminine napkin vendors with small pull knobs.

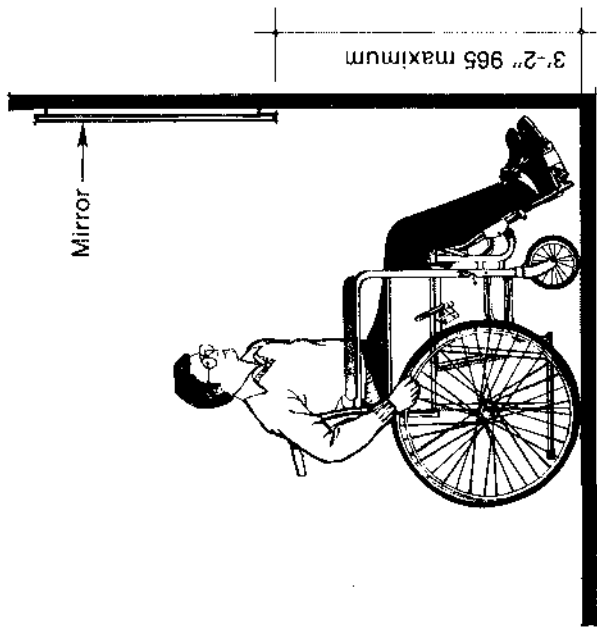
#### **8.1.15**

Dispenser controls shall not require grasping or twisting of the wrist to operate and shall be operable by non-precise movement.

Electrically-operated, hot air, hand-drier air outlets sometimes burn the hands of the blind as they feel the equipment in their search for the knob to operate the device. This part becomes hot after continuous use, especially at peak periods, such as coffee and lunch breaks.

#### **8.1.16**

Hot air hand drying equipment shall be designed so that hands cannot accidentally touch the heating element. The surface temperature of any part of a hand drier directing warm air shall not exceed 105°F. Alternate methods of hand drying shall be provided where this temperature is exceeded.



**Figure 8.1.13**  
Height requirement for mirrors

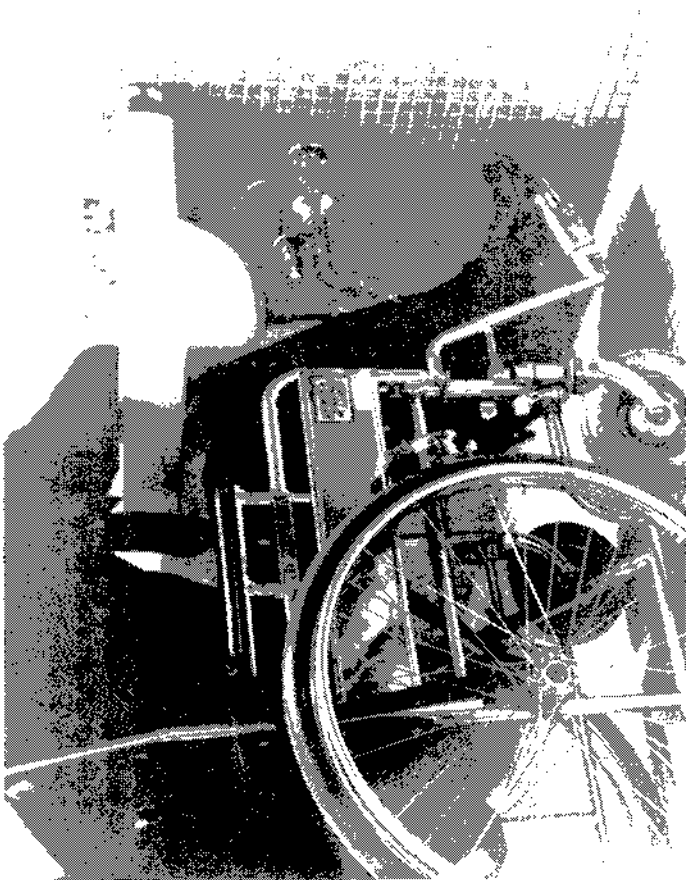
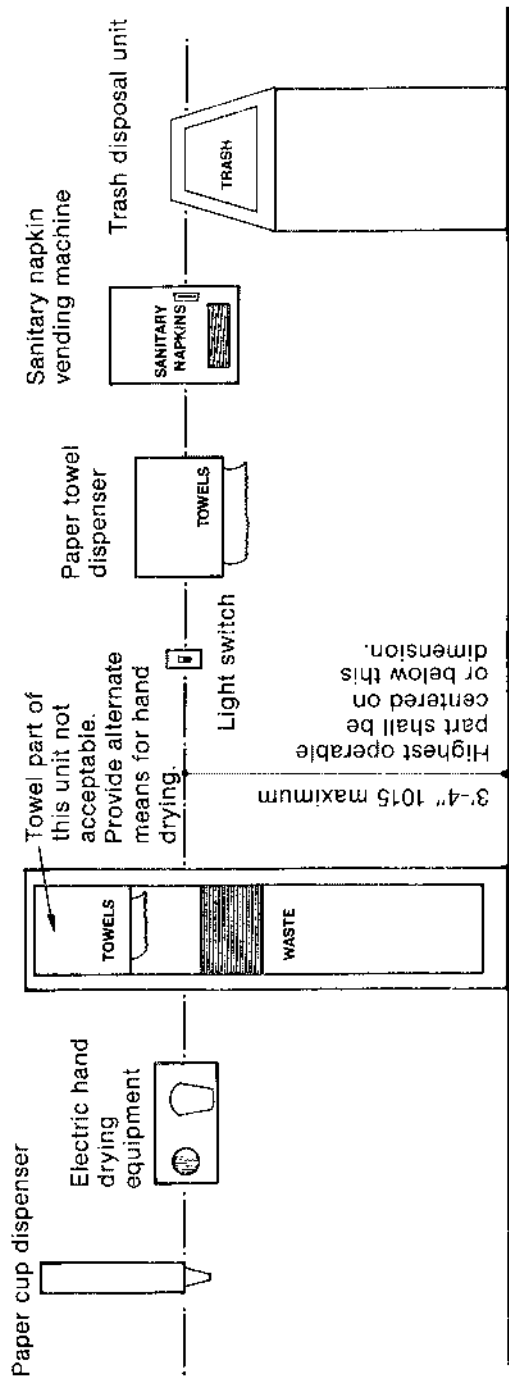


Photo: Peter Wachter

Lavatory mounted with 2'-6" clearance below the apron, and with hot water temperature of 105° F delivered at the faucet.



**Figure 8.1.14**  
Mounting height of dispensers, receptacles and light switches in toilet rooms.

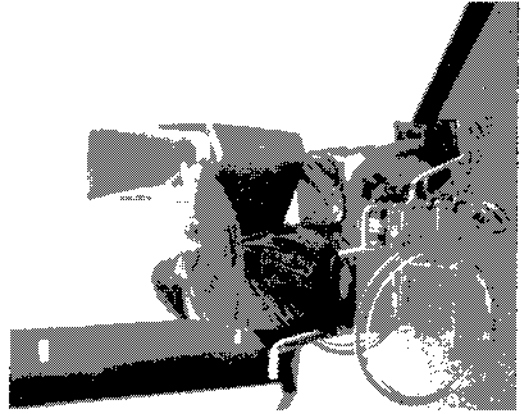
Renal and urinary excretory systems function optimally when people are standing and walking. People in wheelchairs have their excretory functions adversely affected. Their kidneys excrete larger than normal amounts of minerals and salts which have been released into the blood stream as a result of immobility on other body organs. It is imperative that large amounts of fluids be taken throughout the day to dilute urine and thus prevent the likelihood of bladder and kidney stones, as well as urinary tract infection, which is a major killer of paraplegics and quadriplegics. Water fountains must be accessible to people in wheelchairs to help provide the daily fluid intake. Water fountains and coolers are not luxuries to disabled people.

Drinking fountains are often located in narrow recesses, which prevent access to those in wheelchairs.

Two hazards occur if the head of a recess, provided for a drinking fountain, is too low. A blind person may bang his forehead as he bends over to drink, or he may bang the back of his head on the soffit as he straightens up after drinking.

Drinking fountain water spouts are often too high for persons in wheelchairs, small people and children.

Persons with problems in bending may have difficulty in drinking from low drinking fountains.



An orifice which directs water away from the user in a wheelchair may not be reached unless that person carries his own cup or disposable cups are provided.

Photo: Michael A. Jones

## 9.1

### DRINKING FOUNTAINS

All drinking fountains and water coolers shall be accessible.

#### 9.1.1

Drinking fountains and water coolers shall not be located in alcoves unless the clear width of the alcove is 2'-0" for depths not exceeding 1'-7" or a clear width of 2'-8" for depths exceeding 1'-7". The head of the recess shall be no lower than 6'-8" from the floor.

#### 9.1.2

The height from the floor to the orifice shall be 2'-6" to 3'-0". Where existing drinking fountains and water coolers have spouts above 3'-0" from the floor, they shall either have an auxiliary fountain or a spigot for cups within 3'-0" from the floor. If a spigot is provided, there shall also be a cup dispenser next to the fountain mounted no more than 3'-4" from the floor to the cups.

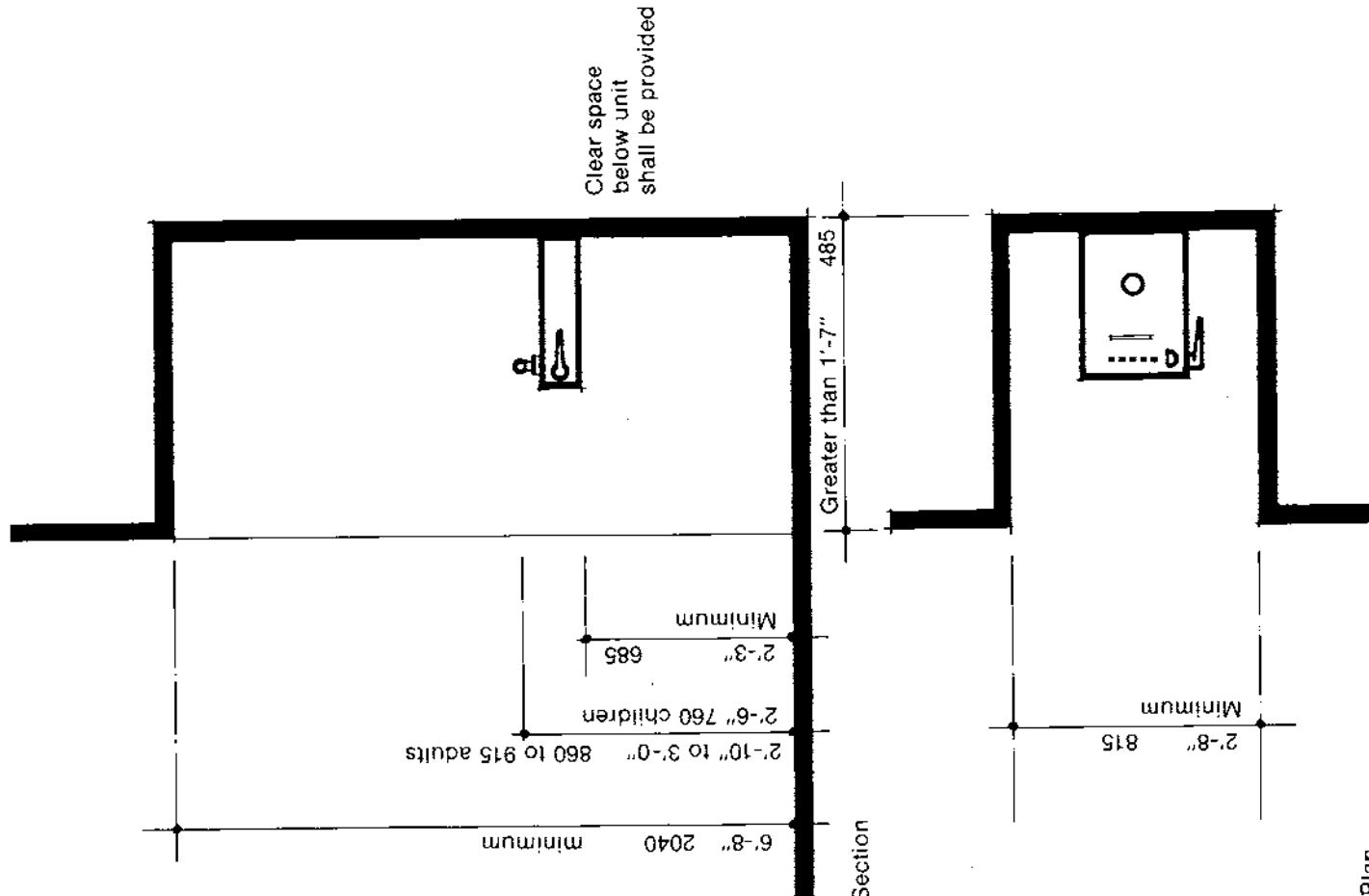
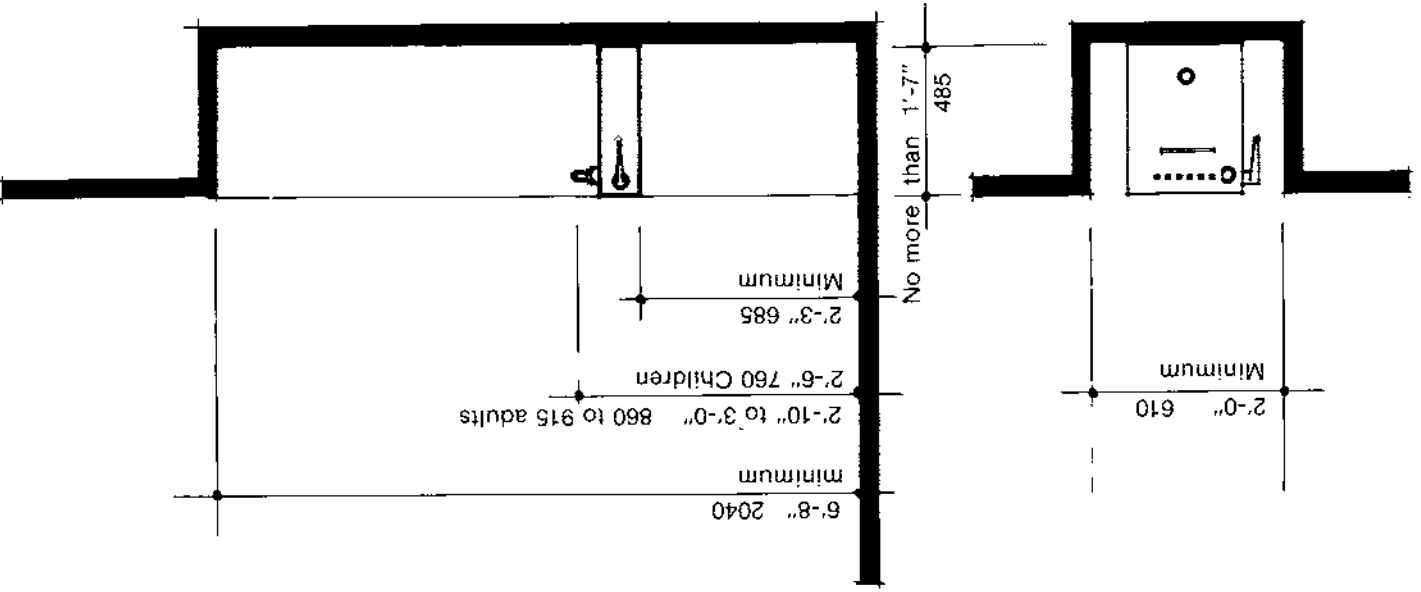


Figure 9.1.1 Requirements for drinking fountains and water coolers in recesses



**9.1.3**

The spout of the drinking fountain or water cooler shall be at the front of the equipment, and should preferably direct the flow of water parallel to the front edge. The fountain or cooler shall allow the insertion of a 4" cup under the flow of water. The maximum volume and trajectory of the water shall be controlled by a device located to prevent adjustment by unauthorized persons, and not by the users hand control.

**9.1.4**

Hand controls shall be required, and shall be operable without the need for precise grasping and twisting, or pinching. A lever is preferred and a multi-arm type handle is acceptable. The force to operate shall be no greater than 3 lbf.

**9.1.5**

Wall mounted units shall have the front panel sloping inward to allow close side approach for wheelchairs. The panel shall slope 2" to 3½" from the vertical, see Figure 9.1.5.

**9.1.6**

There shall be no sharp edges or corners on drinking fountains or water coolers.

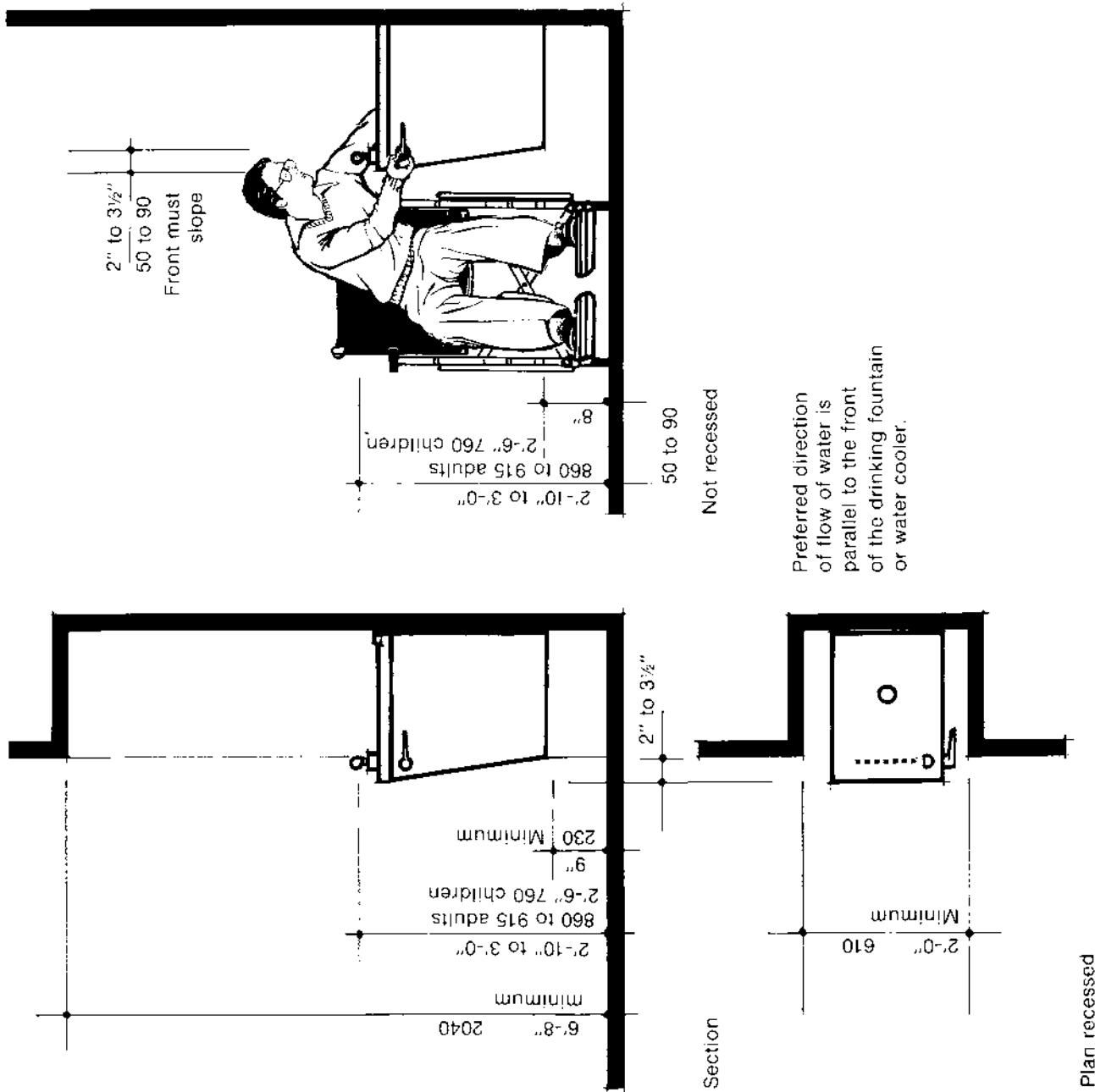
**9.1.7**

Exterior drinking fountains and water coolers shall be located along accessible paths of travel. Where they are located immediately alongside the accessible path, the hard paved surface shall extend at least 2'-0" beyond the equipment at both sides.

Some drinking fountain controls are difficult or impossible to use, especially those that require grasping and twisting of the wrist to operate. Many people, including children, also find thumb-operated push buttons difficult to operate.

Some people find it difficult or impossible to use foot-operated drinking fountains.

Drinking fountains that project from the wall, but have clear space below them, cannot be located by blind people using the long cane technique, and, therefore, become a hazard.



**Figure 9.1.5**  
Requirements for wall mounted units which do not allow forward access to those in wheelchairs.

## 10.1 SHOWER ROOMS

Shower stalls with curbs are difficult to use by those who are semi-ambulatory and are inaccessible for those in wheelchairs who cannot transfer to a shower seat and have to roll into the shower.

### 10.1.1

Where showers are provided, other than residential facilities, a minimum of one of the showers for each sex shall be accessible. The accessible shower shall be a minimum of 3'-0" x 3'-0", inside dimensions. A well padded seat shall be positioned 1'-7" above the floor, and shall be hinged to fold up against the wall. Grab bars shall be installed on two walls at 1'-1" above the seat and shall meet the requirements of Section 14.2. Supports. See Figure 10.1.1.

### 10.1.2

When gang-showers are provided, no individual hand-capped shower need be provided unless there are curbs which prevent wheelchair access. A manually-operated wheel chair shall be provided for showering. At least one water control and flexible hand held shower spray shall be provided and meet the requirements of Section 10.1.14.

### 10.1.3

Shower stalls shall have a floor surface which is slip-resistant under wet conditions, see Section 13.1.6.

### 10.1.4

Sometimes it is difficult to understand how to operate shower controls, or to see which are the cold and hot positions.

Shower controls, operated by grasping and pulling or grasping and twisting of the wrist, are difficult or impossible for those with upper limb impairment to use.

It is difficult for a non-ambulatory person to wash and rinse his back and buttocks when showering unless a flexible, hand-held shower spray is provided. This provision also allows the temperature of the water to be tested safely before showering.

Water controls shall be of a single lever design. A flexible hand held shower spray shall be permanently installed with a hook to hold it located 3'-4" to 4'-0" above the floor surface. The hose shall be 4'-6" in length. A diversionary valve shall be installed to change the water flow from the hand held shower to the fixed head shower.

### 10.1.5

The temperature of hot water delivered to the shower shall not exceed 105°F.

### 10.1.6

The soap tray shall be no more than 3'-4" above the floor.



When public telephones are located away from main circulation routes, people with stamina and mobility limitations have to make unnecessary and exhausting journeys to use the equipment.

Telephones are sometimes located in obscure places, making it difficult for the visually impaired to locate them.

It is difficult or impossible for some people to put money in pay telephone slots:

- a. because of incoordination, their hands cannot approach the slot with precision.
- b. because of amputation, the coins cannot be held and placed into the slot.
- c. because the slot is too high for children, small people and those in wheelchairs.
- d. because the slot is designed without tolerance to accommodate the placing of coins by those with manipulation problems.

The length of time required to put coins in a pay telephone by some disabled people may result in them losing the call.

Some pay telephone enclosures project into circulation spaces, creating hazards for those with severe visual impairment.

The blind can locate column-supported telephones with canes, but cannot identify the width of the equipment. They often injure themselves on enclosures which project considerably beyond the support.

Some public telephone enclosures have entrances which are too narrow for wheelchair entry.

## 11.1

### COIN OPERATED PUBLIC AND SEMI-PUBLIC TELEPHONES

All public and semi-public coin operated telephones shall be accessible.

#### 11.1.1

Pay telephones shall have the highest operable part of the telephone at 4'-6" above the floor level where there is "dial-tone-first" to get the operator without inserting coins, and located to allow side access for those in wheelchairs. Where there are existing structural constraints which prevent side access, and/or there is not "dial-tone-first", one telephone in the bank shall be located with the highest operable part of the telephone at 4'-0" above the floor level.

#### 11.1.2

Pay telephones shall be mounted on walls, free standing pylons, or in enclosures without doors. Bases and enclosures shall not impede the approaches to the equipment by those in wheelchairs. There shall be 2'-6" clearance from the floor surface to the underside of any enclosure or shelf, with the exception of telephones mounted at 4'-0" from the floor to the highest operable part.

#### 11.1.3

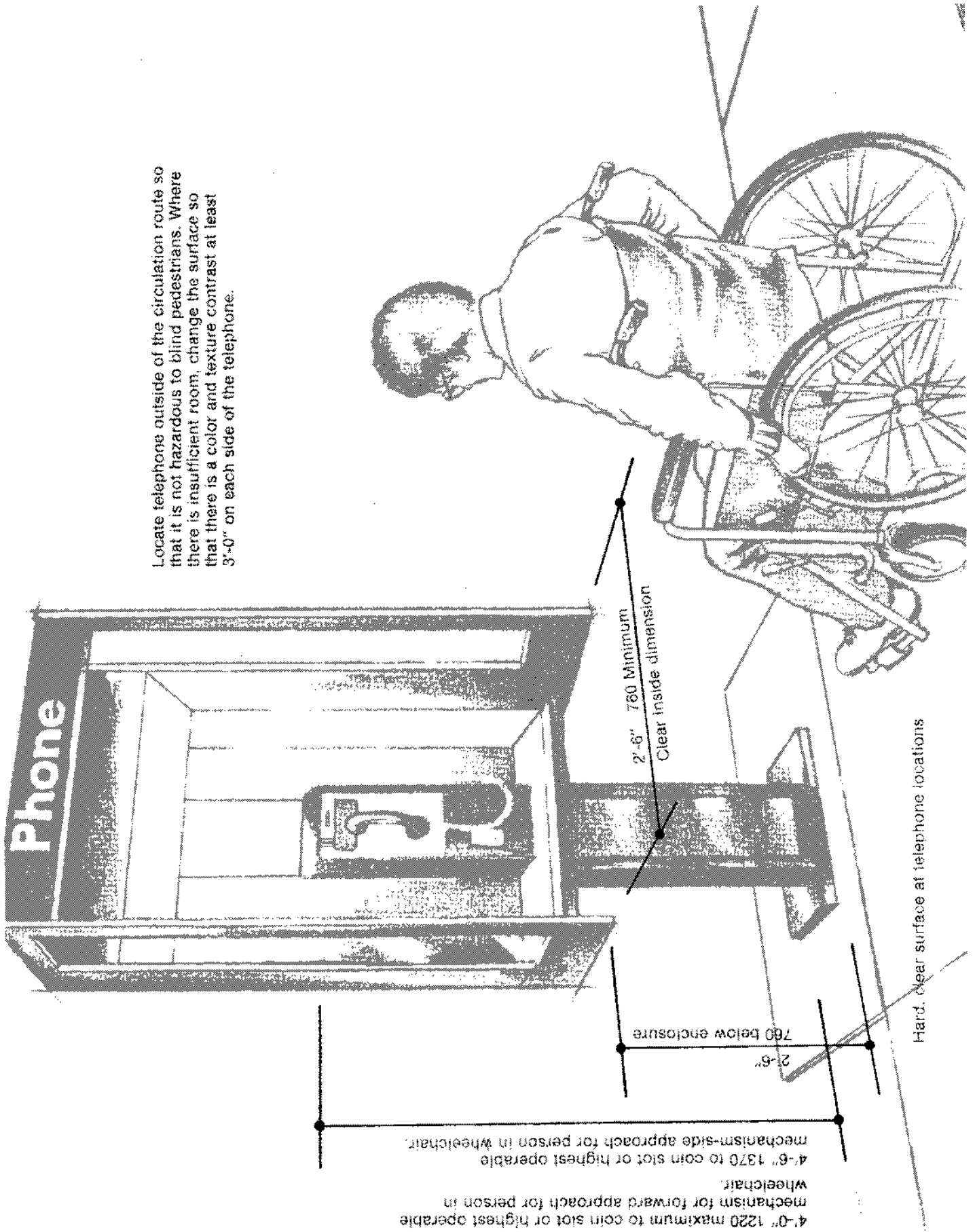
Pay telephones shall not be located so they are hazards in circulation routes.

#### 11.1.4

Entrances to telephone enclosures shall have a clear width of at least 2'-6".

4'-0" 1220 maximum to coin slot or highest operable mechanism for forward approach for person in wheelchair.

4'-6" 1370 to coin slot or highest operable mechanism-side approach for person in wheelchair.



Locate telephone outside of the circulation route so that it is not hazardous to blind pedestrians. Where there is insufficient room, change the surface so that there is a color and texture contrast at least 3'-0" on each side of the telephone.

Hard, clear surface at telephone locations

Telephones which cannot be approached without using stairs or curbs are inaccessible to some and difficult to reach for others.

#### **11.1.5**

Telephones and supporting equipment shall be located on hard surfaces, large enough to allow wheelchairs to maneuver in front and at both sides, see Section 2.3.2, Space Requirements for Maneuvering Wheelchairs.

The shelf under a pay telephone is sometimes located too low, so that those in wheelchairs are prevented from approaching close enough to be able to reach the coin slot or handset.

#### **11.1.6**

Telephone books, if provided, shall be located in a way that allows access and use by persons in wheelchairs. Loose books, if provided, shall be equipped with a tether.

Dials are difficult or impossible for people with upper limb impairment and wrist or finger manipulation impairment to use. However, there are others who can only manage dials and not buttons.

#### **11.1.7**

Coin-operated telephones shall have push button controls where this service is available.

When the coin-operated telephone cord is too short, people who are small or who are seated are prevented from bringing the handset to their ear/mouth.

#### **11.1.8**

The length of the cord from the telephone to the handset shall be at least 2'-6".

Instructions for the use of coin-operated telephones are not accompanied by a tactile equivalent – braille or raised letters. When the operator requests the number of the telephone from which the call is being made, the blind cannot give it.

#### **11.1.9**

To aid the visually impaired in making operator assisted calls, the operator must be able to obtain the called and calling number. This shall be accomplished by electronic means, or the telephone number shall be provided in a tactile form, either in raised numerals or with a braille equivalent placed below the buttons. The numbers shall be ½" high and raised ⅛".

The severely audibly impaired have difficulty using, or cannot use, telephones unless they are equipped with amplifiers.

#### **11.1.10**

At any public telephone location, such as State or civic buildings, hotels, motels, transportation terminals and stations, medical facilities, shopping centers and department stores, or where an evidenced need for an adjustable volume control is brought to the attention of the telephone company, it shall be provided and clearly marked, see Figure 11.1.10.

Some telephone receivers are incompatible with hearing aids, and thus the hearing impaired cannot use the service.

#### **11.1.11**

Telephone receivers shall generate a magnetic field in the area of the receiver cap. This is required for persons wearing hearing aids with an inductive pickup.

Figure 11.1.10  
Adjustable volume control



Example of handset with  
adjustable control



Figure 11.1.11  
Example of sign



The illumination level in telephone booths or enclosures is often not adequate to permit those with visual impairment to read the fine print in the telephone directory.

The deaf are denied telephone communication unless they have their own teletypewriter machine. As this is an expensive item, few deaf people can afford it.

If deaf people have teletypewriter equipment in their homes, their telephone costs are higher than those of the hearing population because of the time required to type the messages. The deaf also have to absorb the initial costs of teletype equipment.

Often pay telephones (particularly accessible telephones which are wall mounted) have no acoustic baffling, and external noises make it difficult to hear telephone conversations. This is a great problem for the hearing impaired.

#### 11.1.12

The minimum illumination at the telephone shall be at least 5 footcandles provided by the subscriber or leasee.



A communication deficit is often one of the major causes of a person's inability to achieve the benefits and rights taken for granted by most non-handicapped individuals. Communication barriers deny the handicapped individual full participation in society.

Most able-bodied persons display negative attitudes toward the handicapped, which often manifests itself in noncommunication. Most hearing people do not understand the deaf, their difficulties in communicating, or their varying limitations of the English language.

Available communication systems have not been used effectively to change societal attitudes and behaviors toward disabled people.

Many deaf people have severely restricted interpersonal relationships which result in impoverished language. This prevents the development of adequate educational, social, recreational, cultural and vocational skills.

Hearing people may doubt that the audibly impaired with good speech are, in fact, having hearing difficulties.

The deaf person frequently lives in isolation which may not be penetrated by society even for the purposes of communicating life-saving messages.

Repetition of identical corridors, lobbies, doors, materials, textures, color, furniture, windows and lighting confuses many people, particularly the mentally retarded, senile, some elderly people, and children. It can cause them to become lost or disoriented. In large offices or residential settings, repetition of elements is monotonous and impersonal.

Public information given only in visual form creates a communication barrier for the visually impaired person and reduces his ability to function in an independent manner.

Transportation systems using signs containing information on schedules, announcements, street names, etc., in small print provide problems for the visually impaired.

## 12.

### COMMUNICATION AND IDENTIFICATION

The major purpose of communication and identification systems in the built environment is to provide people with:

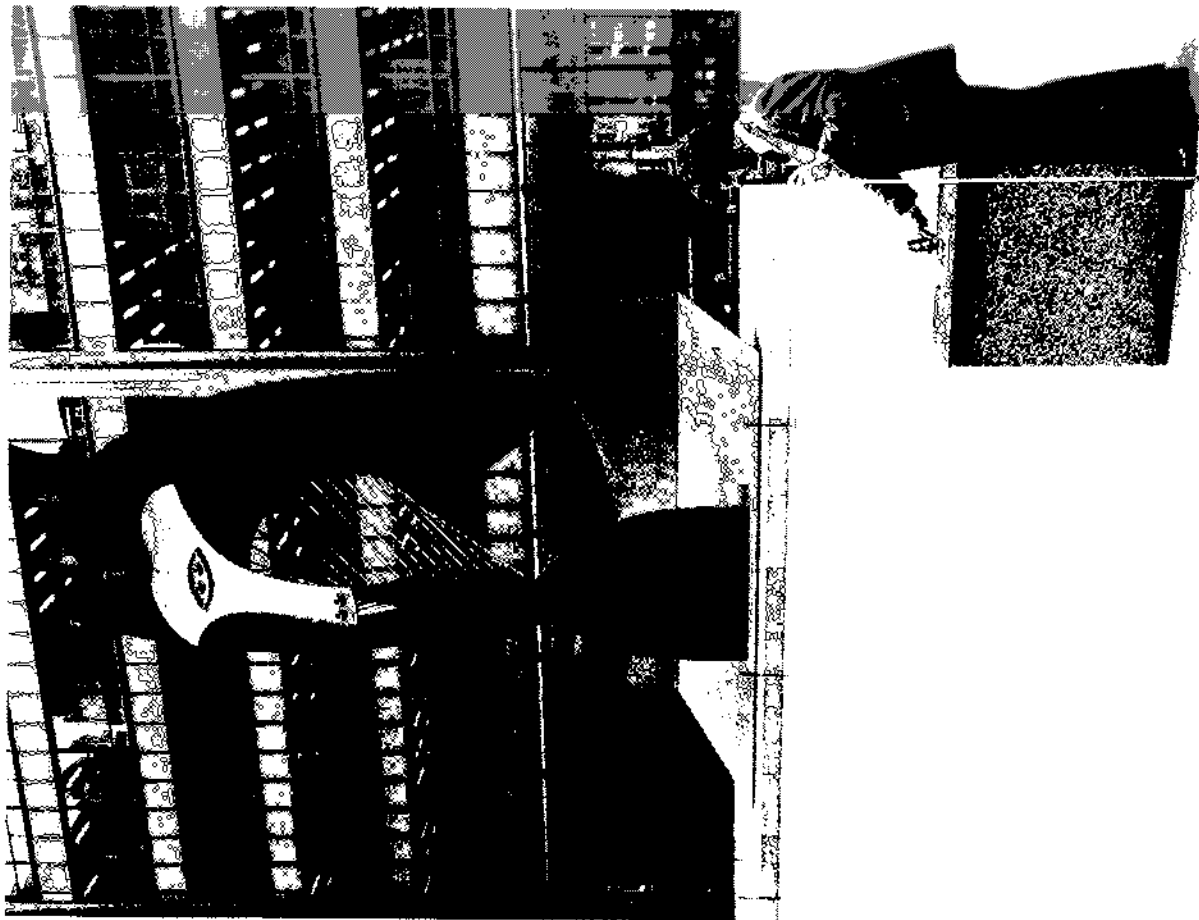
- a. information regarding general orientation or layout of buildings or facilities—shopping center plans, building layouts, bus routes, etc.
- b. directional information to building, facilities or specific rooms within facilities.
- c. identification of specific areas or rooms.
- d. instructional information regarding the use of devices within buildings or facilities—banks of elevators serving different floors, telephone operation instructions, etc.
- e. emergency and warning requirements—fire alarms, stop signs, emergency exits, etc.

The proportion of visitors to employees will determine how comprehensive the communication and identification systems will be. In an office building, where the ratio of employees to visitors is high, only the public areas—main entrance elevator lobbies and toilets—need signage as employees can be expected to learn access routes and the location of facilities. In a museum, a different situation occurs. An extremely comprehensive communication and identification system is required, as visitors need help in locating the building's facilities.

## 12.1

### SIGNAGE

Where identification signs, directional signs, including maps or layouts, or informational signs are required, they shall be provided in tactile form for the blind.



A small replica of Picasso's sculpture in the Richard J. Daley Center provides blind people an opportunity of experiencing the artist's work. A tactile layout of the center is also provided to orient and guide the blind through the complex.

Photo: Scott Schlessner

Where there is inadequate signage in buildings, the hearing and speech impaired may not be able to communicate with their abled counterpart for directions. The problem is caused mainly by a lack of understanding on the hearing person's part. This inability to communicate may cause depreciation of self-esteem, as well as creating confusing situations.

Lettering on signs is frequently too small to be read by those with low vision.

Blind persons have no way of identifying room numbers or names, unless they are written in a tactile form.

### 12.1.1

Where directional signs are used in buildings to indicate the location of toilets, vertical circulation, room or unit numbers, or spaces with different functions, they shall be located to provide maximum visual exposure along routes of travel, especially at the intersection of circulation routes and elevator lobbies. There shall be a consistency of location and type of sign providing information throughout a building.

### 12.1.2

Where room identification signs and numbers are used, they shall have raised characters. These signs shall be placed in a standardized location throughout the building alongside the door at the latch side, and mounted at a height range of 4'-6" to 5'-0". Raised characters shall be raised at least  $\frac{1}{32}$ ", have sharply defined edges, and be at least  $\frac{5}{8}$ " high.

### 12.1.3

Characters on emergency, directional and instructional signs shall have a stroke width to height ratio of 1:6 to 1:10, and a character width to height ratio of 3:5 to 1:1, see Figure 12.1.3.

### 12.1.4

Signage shall have contrasting colors between the characters and the background, preferably a light color on a dark background.

### 12.1.5

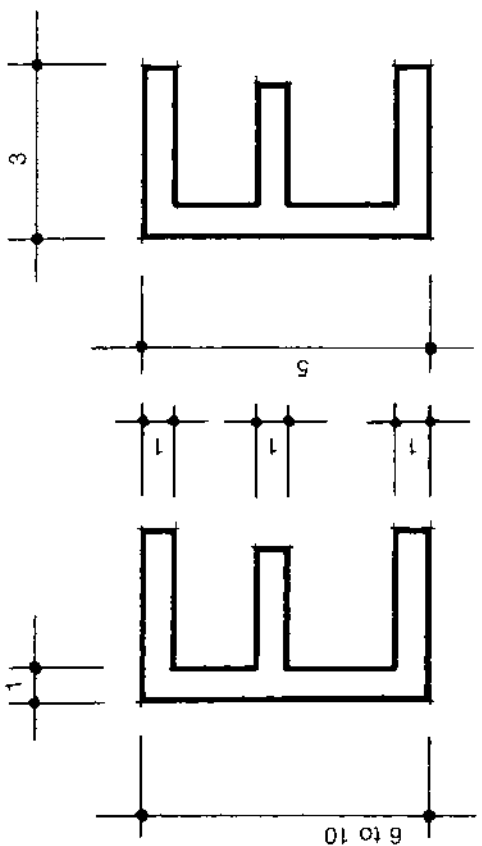
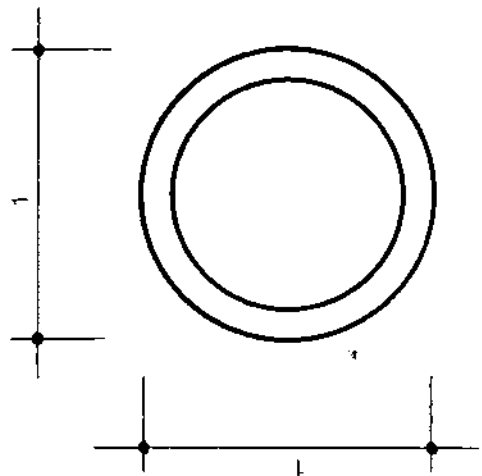
Signs shall have glare free surfaces which will not interfere with legibility.

### 12.1.6

Signs with descriptive material about public buildings, monuments and objects of a cultural interest shall have raised letters if audio tape devices, sighted guides, or braille brochures are not available to present the identical information.

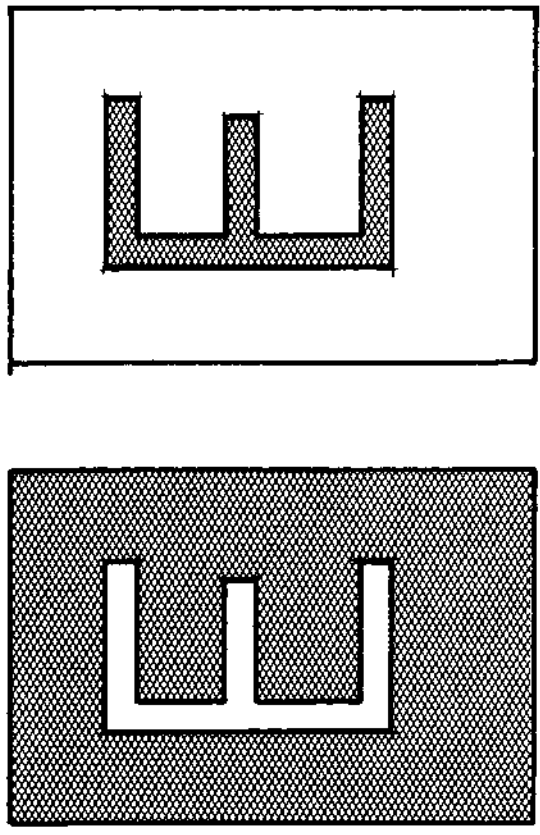
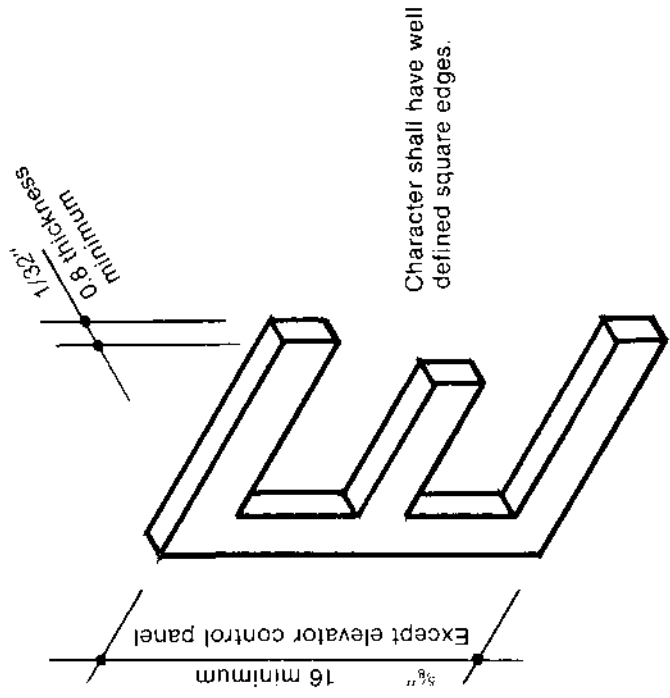
Where there is insufficient color contrast between letters and the sign background, legibility problems are created for those with low vision.

The elderly and visually impaired may have difficulty when reading signs placed behind glass or signs with reflective surfaces because of glare or reflection from the surface. They may need more light to read, yet a higher level of illumination increases the glare from reflective surfaces.



Stroke width to height Ratio 1:6 to 1:10  
Character height to width ratio 3.5 to 1:1

Figure 12.1.3 Requirements for characters on signage.



Light color character on a dark background is preferred.

Figure 12.1.4 Character shall contrast with background

Figure 12.1.2 Requirements for raised characters

Some buildings are not provided with visual indication of the whereabouts of specific areas such as cloakrooms, toilet facilities, telephones, departments or offices. This creates communication difficulties for the speech or hearing impaired who may not be able to make inquiries or hear answers to their questions.

### 12.1.7

The International Symbol of Accessibility shall be displayed in the following places:

- a. at all major entrances to a building or facility which is accessible. Directions shall be placed immediately alongside of the symbol indicating the directions to the nearest accessible entrance, if that entrance is inaccessible.
- b. at the entrance to all public toilet rooms. If one is inaccessible, directions shall be placed alongside the symbol to indicate the nearest accessible toilet room.
- c. at the origins of accessible paths of travel to major publicly used spaces, with directions to the nearest accessible path of travel, if all are not accessible.
- d. Where signs, building layout diagrams or maps are provided, the Symbol of Accessibility shall indicate where accessible toilet rooms, entrances and elevators are located. Layout diagrams or maps shall be oriented from the standpoint of the viewer, and the viewer's position clearly indicated.
- e. Where parking spaces are provided for persons who are handicapped, the Symbol of Accessibility shall be mounted on a pole or wall, facing the direction of entry, and may be accompanied by markings painted on the parking surface.

### 12.1.8

The Symbol of Accessibility to be displayed is shown in Figure 12.1.8.

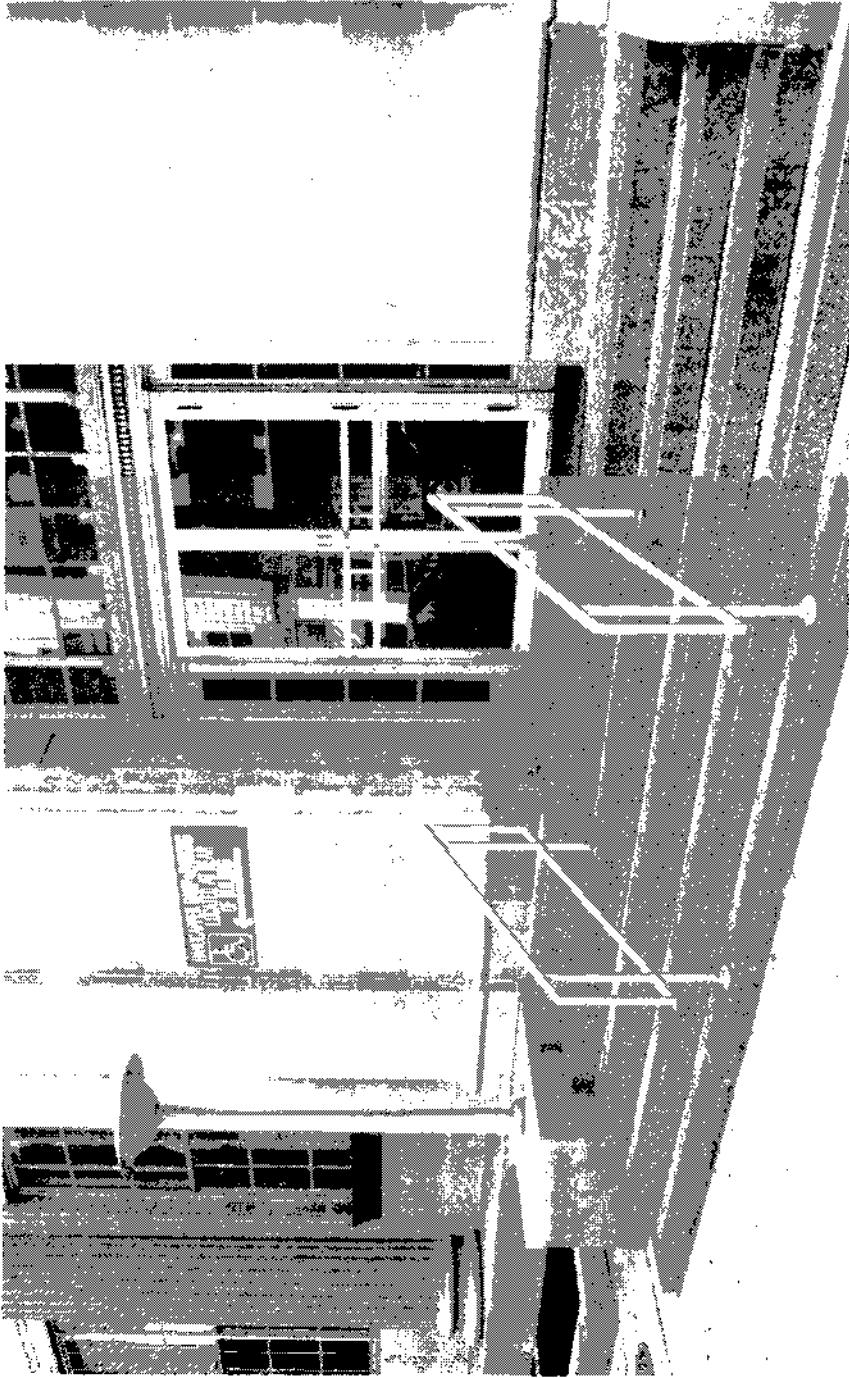
Buildings with areas lacking sound-absorbing materials create problems for the person who is hard of hearing. Distracting background noises interfere with the hearing-aid amplification and perplex hearing impaired persons. Disturbing noises include background music, traffic roar or mechanical sounds from air-conditioning and other similar equipment.

Complicated routes to the fire exit make it difficult for visually impaired persons to exit quickly. They may also be confusing to some people with limited cognizance of the environment.

### 12.2

#### **EMERGENCY WARNING SIGNALS AND ALARMS**

Emergency warning signals and alarms shall be located and designed so that they can be easily seen, heard and understood.



Inaccessible entrance with international symbol of accessibility plus directions to the accessible entrance.

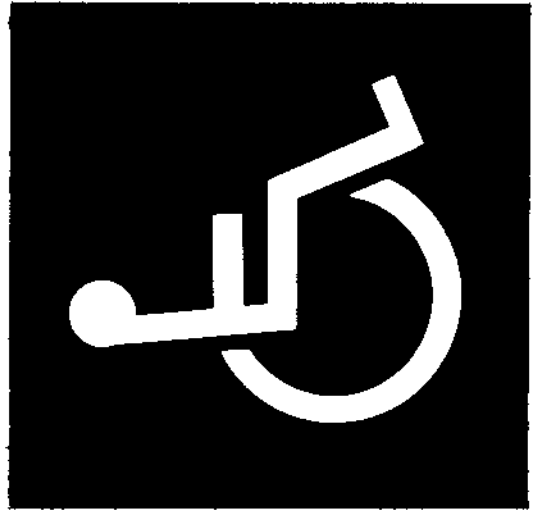
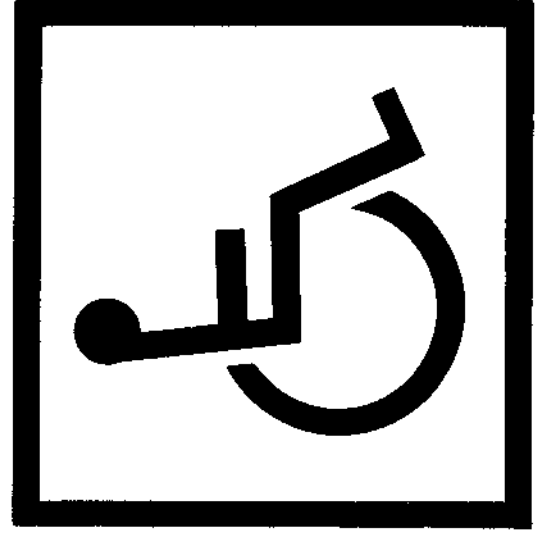


Figure 12.1.8 International symbol of accessibility



Frequently, audible emergency warnings are not visually communicated to the deaf.

Visual warning signals may fail to alert persons with hearing disabilities when they are asleep, and even when awake, the visual warning may not be located so that a hearing-impaired person will see it.

### **12.2.1**

Both visual and audible emergency warning systems shall be provided. Illuminated emergency exit signs shall flash as a visual emergency alarm with a frequency not exceeding 5 Hz. Audible emergency alarms shall produce a sound level which exceeds the normal prevailing equivalent sound level at the intended listeners ears by at least 15 dB. Alarm signal sound levels shall not exceed 120 dB.

### **12.2.2**

Visual emergency alarm devices shall be located so that the signal and/or reflection shall be seen anywhere in the space. If such systems utilize a permanently installed electrical power source, they shall be installed on the same circuit as the audible emergency alarms. Visual emergency alarm devices may also be wireless and portable, and be provided by the building owner or management for use at the request of a deaf person. If portable visual emergency alarm devices are selected, at least two shall be available.

### **12.2.3**

Emergency exit manual door openers shall be identifiable by tactile means. These openers shall have a roughened surface on the parts of the opener that come into contact with the hand. This change of texture may be achieved by knurling or the application of an abrasive finish to the handle, and shall be standardized throughout a building or facility.

### **12.2.4**

Areas or spaces with microwave ovens shall be identified for the benefit of people with heart pacemakers. See Figure 12.2.4.

### **12.2.5**

Fire alarms are sometimes too high to be used by children, short people or persons in wheelchairs. The means of operation may not be obvious or may be difficult to activate.

Fire alarm devices shall be located 3'-4" to 4'-0" from the floor level to the center line of the operable mechanism, and meet the requirements of Section 14.1, Controls, Dispensers and Receptacles.



Figure 12.2.4  
Example of sign with microwave oven warning.

## **TACTILE WARNING SIGNALS AND BLIND LOCATION CUES**

### **12.3**

#### **12.3.1**

Tactile warning signals on walking surfaces shall be provided when required by these Standards to alert the blind and visually impaired of possible hazards in the pedestrian path which might result in falls, or conflicts with vehicular traffic. Curb edges are an acceptable blind location cue.

#### **12.3.2**

Where tactile warning signals are required, the surface texture pattern shall be consistent within a building, facility and/or site development.

#### **12.3.3**

The tactile warning signal pattern shall only be used as an alert to hazardous situations and not used on any other walking surfaces.

#### **12.3.4**

The pattern of the tactile warning signal shall be one of the following:

- a. Applied strips to the walking surface forming grooves  $\frac{1}{8}$ " deep between the strips, and bonded to the surface to prevent delamination.
- b. A continuous sheet material with grooves  $\frac{1}{16}$ " minimum depth forming an integral part of the surface, and bonded to the surface to prevent delamination.
- c. Grooves  $\frac{1}{8}$ " deep cut or formed in the surface of the walkway base material.
- d. A change of material from that used on the walkway to another material with grooves  $\frac{1}{8}$ " deep cut or formed in the surface.

The width of the tactile warning signal, perpendicular to the grooves, shall be 2'-0" if there is a perceivable difference in hardness between the walkway and the tactile warning signal, and 3'-0" if there is no perceivable difference. See Figure 12.3.4, A, B, C, D, and Table 12.3.4 for the comparison of hardness of walkway materials.



**12.3.5**

Grooves shall be 1/4" wide and spaced 3/4" to 2" apart. A random pattern is not acceptable.

**12.3.6**

Blind location cues shall be achieved by changes in surface textures on the walkway to help blind people orient themselves and/or locate building elements such as entrance doors, drinking fountains, pay telephones, etc., as required in these Standards. Blind location cues shall not be the same as tactile warning signals. Change in the hardness of the materials or change in surface textures are acceptable. Textural changes shall not result in obstruction to the caster wheel of wheelchairs, or tripping hazards.

**12.3.7**

To provide advance warning of curb ramps, the surface of the ramp shall have a change in texture and color from that of the surrounding walk.

**12.3.8**

Tactile warning signals and blind location cues shall have a contrasting color to the walkway surface color to aid the visually impaired.

**12.3.9**

A textured strip shall be used as a blind location cue:

- a. Where vehicular and pedestrian areas abut at a common surface, and no other physical barrier is provided.
- b. Where lines are painted on surfaces to define a pedestrian walk, such as through a parking lot, it shall be applied on both sides of the walk.
- c. Where oblique pedestrian crosswalks occur.

The strip shall be continuous along the hazard, shall be 4" wide and shall be composed of either 1/4" maximum size gravel embedded in epoxy cement, or a resilient surfacing material applied to the surface, not thicker than 1/4" and textured.



### 13.1

#### GROUND AND FLOOR SURFACES

Ground and floor surfaces shall not present slipping hazards to ambulatory and semi-ambulatory people, nor present obstacles to the movement of people in wheelchairs.

Brick and concrete pavers present many difficulties to handicapped pedestrians. Joints which are not flush with the adjacent surfaces cause excessive bumping to those in wheelchairs. This jolting can cause spasticity in some people, severe head pains in others, and can aggravate the pressure sores caused through constant sitting.

#### 13.1.1

Outdoor ground and walk surfaces in accessible areas shall not have large or continuous areas of small unit components, such as brick or stone, unless they are laid on a firm and stable base, the joints are flush with adjacent surfaces and they are not more than ½" wide.

Recessed joints hold water which produces very slippery surfaces in freezing weather. Similar joints can fill with moss or weeds, creating a hazardous surface.

#### 13.1.2

Small unit components, such as brick, shall not be used on stairs unless the edge of the tread is of a contrasting color and clearly distinguishable from any joints.

The maintenance of brick and concrete pavers is usually poor so that tripping hazards, once created, remain. Uneven surfaces are created by the freeze/thaw cycle, differential settlement, or the erosion of an unstable sub-base. It is difficult or impossible to push a wheelchair over these surfaces.

The visually impaired and the elderly with compound problems of reduced vision and poor gait find jointed surfaces extremely hazardous.

Lower limb amputees, arthritics, those with fixed ankle braces, poor balance or incoordination can trip and fall on very minor changes of level. A ¼" vertical change in the surface is sufficient to turn an ankle, upset balance, or cause a fall.

It requires great effort by those in wheelchairs to push themselves across carpets with underlayment (carpet cushion) or thick pile carpets. For some, it can become too tiring for them to continue independently.

#### 13.1.3

Carpet laid on floor, stair, or ramp surfaces shall be securely attached, have a tight weave, low pile and firm underlayment. No underlayment and an uncut pile is preferred, especially in circulation routes.

It is difficult to distinguish nosings on stairs when heavily patterned carpets, especially patterns with straight lines, are used. Stairs constructed of jointed materials, such as brick, make stairs difficult to use because the joints and the nosing can become indistinguishable.

#### 13.1.4

Heavily patterned carpet, especially designs incorporating stripes, shall not be used on stairs.





Small thresholds which are not adequately bevelled can stop a wheelchair or trip a person with gait problems.

**13.1.5**

Exposed edges of carpet shall be fastened to floor surfaces with trim along the entire exposed edge. Carpet trim shall be bevelled with a slope no greater than 1:2.

Some surfaces are very slippery. Marble worn smooth can be hazardous, while other materials become hazardous when wet.

**13.1.6**

All floor finishes shall be slip resistant, firm and stable. The friction coefficient of the surface shall be no less than 0.5 wet or dry, when measured by static means using the Underwriters' Laboratories Friction Test Method/Card Data Method No. UL 239, employing the James Machine.

Static electricity is generated when moving over some carpets. When a person with balance or agility problems touches a metal door knob, the "shock" can be severe enough to cause the person to fall.



## 14.1 LOCATION OF CONTROLS, DISPENSERS AND RECEPTACLES

Many controls are difficult to operate for those with problems of manual dexterity, as they require fine finger manipulation, rotation of the wrist, or a pulling or pushing movement which require too much force.

Mail boxes are often too high or too difficult to open.

Laundromat equipment often has coin slots and control switches which are difficult to reach or operate by short people and people in wheelchairs.

Heating and air conditioning controls are positioned too high for short people or those in wheelchairs to use.

**14.1.1** All controls, dispensers, vending machines and receptacles shall be located so that people in wheelchairs can position themselves within reach of operable parts, see Section 2.3.1, Wheelchair Dimensions and Section 2.3.2, Space Requirements for Maneuvering Wheelchairs, and Fig. 14.1.1.

**14.1.2** Where side access for those in wheelchairs is possible, the highest operable part of controls, dispensers, vending machines and receptacles shall be located a maximum height of 4'-6" from the floor to the center of the operable part of the device. When location allows forward access only for those in wheelchairs, the maximum height of the highest operable part from the floor to the center shall be 4'-0", see Figure 14.1.2. In toilet rooms and restrooms, dispensers and receptacles shall be mounted with their highest operable part no more than 3'-4" above the floor surface, see Section 8.1.14. Fire alarm pulls or buttons shall be located 3'-4" to 4'-0" from the floor level to the center of the device, see Section 12.2.5, Emergency Warning Signals and Alarms.

Instructions on controls are often too small to be read by the visually impaired. Most do not have click stops and raised letters helpful to the blind.

The operation of heating and air conditioning controls requiring fine manipulation is difficult or impossible for upper limb amputees, arthritics and those with incoordination or other upper limb impairment.

Many mailboxes require the use of both hands to open and insert a letter.

It is impossible or difficult to put coins into a coin slot if there is no guide at the slot to aid a person who has incoordination or limited finger manipulation ability.

It is impossible or difficult to pick up change from a vending machine, especially when only one or two fingers can be inserted, or there is insufficient space to bend the fingers when picking up the coins.

### 14.1.3

Controls shall not require tight grasping or pinching to activate. Forces required to activate controls shall be as small as possible and shall not exceed 3 lbf. Push button, solenoid type controls are preferred over pull type mechanisms. Click stop controls are preferred where a range of operations are controlled by a single control device.

### 14.1.4

Controls, dispensers and receptacles shall not require the use of two hands or two simultaneous movements by one hand to operate.

### 14.1.5

Slots shall be designed to allow for the insertion of coins, tickets or cards in an imprecise manner.

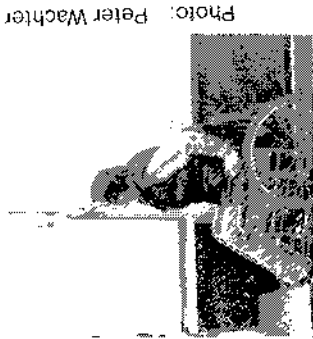
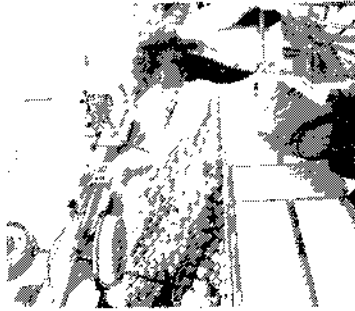


Photo: Peter Wachter

Controls must be within the reach of seated people, no higher than 4'-6" from the floor if forward approach is the only access.



Scales to weigh produce are often out of reach.



The time clock would be more accessible if it was located within easy reach of a seated person, and it would not inconvenience someone standing.

Photo: Illinois Department of Vocational Rehabilitation



Photo: Michael A. Jones

The ticket machine requires this person be able to read and understand the instructions, to raise his arm parallel with the floor, precisely insert coins in a slot and take the ticket from another slot. Both tasks present difficulties to many people.



Photo: Michael A. Jones

Use of this change machine requires a person to be able to bend his elbow, precisely place the bill in the slot, bend the knees and trunk, and take the change out of a poorly designed slot.



Coat hooks are often just out of reach.

Photo: Peter Wachter

**14.1.6** There shall be a minimum illumination of 5 foot candles at all controls, dispensers and receptacles.

**14.2 SUPPORTS**

Supports consist of grab bars, handrails, guardrails, railings and other devices which provide support or assistance to people. Supports shall be strong, safe and easy to use.

**14.2.1** Supports, fasteners and mounting devices shall withstand a load of at least 250 lbf. applied anywhere along the length of the support.

**14.2.2** The outside diameter or width of supports shall be 1½" to 1¾".

**14.2.3** Supports mounted next to a wall shall have a clear space of 1½".

**14.2.4** If projecting ends of supports are hazardous to passers-by, they shall return smoothly to wall, floor or supporting surface.

**14.2.5** Supports shall have no sharp edges or dangerous protrusions, including the fasteners. Edges shall have a minimum radius of ¼".

**14.3 ELECTRICAL FIXTURES AND CONTROLS**

**14.3.1** Electrical outlets shall be mounted at a minimum of 1'-0" above the floor as measured to the centerline of the outlet. For mounting height of switches, thermostats, alarm devices and other controls, see Section 14.1, Location of Controls, Dispensers & Receptacles.

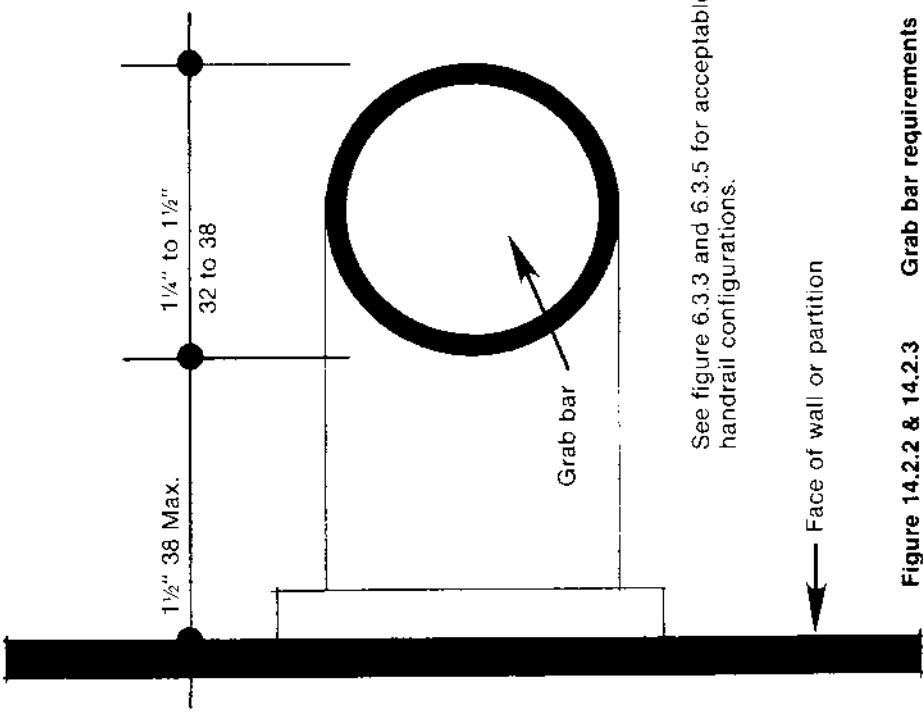
Many support devices become loose or unstable because there is insufficient sub-structure to make a satisfactory installation.

If a semi-ambulatory or non-ambulatory person slips and falls while using a grab bar or rail attached to a wall, his arm may slip down between the rail and the wall if this space exceeds 1½". With little or no leg support, the whole weight of the body is taken on the trapped arm. This can result in a fractured arm.

Electrical outlets are often located just above coved bases and too low to be used by many people in wheelchairs and those who cannot bend their knees or trunk. This latter group includes many elderly people. Light switches are sometimes located too high for people in wheelchairs or children to use.

Light switches that are small in size and stiff in movement are sometimes too difficult for those with upper limb impairment to operate.

**14.3.2** Light switches and thermostats shall not require grasping or pinching in order to activate.



See figure 6.3.3 and 6.3.5 for acceptable handrail configurations.

**Figure 14.2.2 & 14.2.3 Grab bar requirements**

It is often difficult to locate switches in unfamiliar surroundings, such as hotel rooms when it is dark.



Photo: Peter Wachter

Without trunk balance, reaching forward to perform a task is difficult, particularly if work tops are wider than 2'-0". Note the forward movement.



Photo: Peter Wachter

Rough surfaces, projecting screw heads and water pipes and drains with water exceeding 105° F may be hazardous to a person in a wheelchair.

#### 14.3.3

Light switches in hotels and motels shall be illuminated in the bathroom, bedroom and in the hallways between the bathroom and bedrooms.

#### 14.3.4

Electrical outlets, switches and controls shall not be mounted immediately above sinks or lavatories, nor located in shower and tub recesses.

#### 14.4 PLUMBING FIXTURES

##### 14.4.1

All exposed pipes below 4'-0" from the floor that exceed a temperature of 105°F, shall be thermally insulated.

##### 14.4.2

There shall be no sharp or abrasive surfaces under sink or lavatory bowls.

##### 14.4.3

Faucets shall be of a lever design or other designs that do not require grasping or twisting of the wrist as the only means of operation. Single lever mixing type faucets are preferred. Forces needed to activate the faucets shall be as small as possible and shall be no greater than 3 lbf.

##### 14.4.4

For detailed requirements for accessible water closets, lavatories, drinking fountains, shower rooms and bathrooms see Section 8.1, Public Toilets, Section 9.1, Drinking Fountains, Section 10.1, Shower Rooms, Section 16.1.5, Minimum Size Bathrooms Layouts, Section 16.2.4, Minimum Size Hotel Bathrooms Layouts, and Section 16.4.2, Minimum Size Health Facility Bathroom Layout.





Laundry facilities are inaccessible to handicapped people if they are placed in the basement or other areas not served by elevators, or if they are located off inaccessible corridors.

## 15.1

### APPLIANCES FOR PUBLIC USE

**15.1.1** If appliances are provided for public use in apartment buildings, hotels or motels, etc., they shall be located in accessible rooms and at least one of the appliances shall have all controls and compartments within reach of a person in a wheelchair. Dispensers shall be located so that the highest operable part is 3'-4" to 4'-0" from the floor surface, see Figure 15.1.1.

#### 15.1.2

Automatic washing machines and clothes dryers accessible to a person in a wheelchair shall be the front loading type. They shall be installed so that loading and unloading of clothes can be accomplished within the reach of a person in a wheelchair, see Section 2.3.3, Reaching from a Wheelchair and Figure 15.1.1.

#### 15.1.3

Unit air conditioners shall be installed so that all controls and adjustments that are essential for consumer use are within reach of a person in a wheelchair, and mounted no higher than 4'-0" from the floor to the center of the operable mechanism, see Section 14.1, Location of Controls, Dispensers and Receptacles.

Heating and air conditioning controls are positioned too high for short people or those in wheelchairs to use.

The operation of heating and air conditioning controls requiring fine manipulation is difficult or impossible for upper limb amputees, arthritics and those with incoordination or other upper limb impairment.



## ADDITIONAL REQUIREMENTS FOR SPECIFIC BUILDING TYPES

The specific requirements for these building types shall not be considered as exempting them from other requirements of these Standards.

### 16.1 RESIDENTIAL STRUCTURES

All publicly and privately owned residential structures shall conform to the following requirements except single family and two family residences and the second and third floors of apartment buildings not served by elevators. These are minimum requirements and do not satisfy the requirements for specialized housing built expressly for the handicapped or elderly.

Many disabled citizens have little choice of housing accommodation. Many cannot afford to pay for changes to the structure to make it accessible. However, disabled persons who can lead independent lives do not want to live in specialized housing that is provided for the severely disabled or elderly. Housing that is basically accessible would allow a choice of housing currently denied the handicapped.

There is insufficient specialized housing available for the severely disabled. The cost for attendants to help the severely disabled can be shared in such facilities.

If only a specific percentage of accessible units are provided in housing projects, disabled persons will not be able to visit friends in the inaccessible units.

As people become mobility limited because of age or injury, they often have to leave their homes and neighborhoods because their houses cannot be adapted to their changing needs without great expense.

It is often impossible for disabled persons to use public facilities in apartments because they are frequently in the basement served only by stairs. Public facilities include laundries, meeting rooms and storage areas.

#### 16.1.1

All areas open to and useable by the public, both externally and internally, shall comply with the requirements of this Standard. This includes site facilities, lobbies, laundries, game rooms, parking garages, etc.

#### 16.1.2

Doors into all dwelling units and doors or openings into any room or space within the dwelling unit shall have a minimum clear width of 2'-8". See Section 4.1, Entrances, Doors and Doorways. Reach-in closets or reach-in storage spaces are excluded.

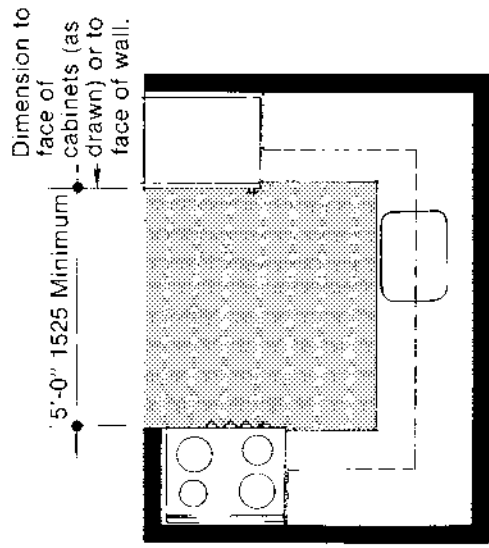
#### 16.1.3

Hallways and corridors within the dwelling unit shall have a minimum clear width of 3'-6".

#### 16.1.4

Kitchens which have a U or L shaped cabinet layout shall have a minimum clear width of 5'-0" between the countertop front edges or countertop front edge and opposite wall. Kitchens with countertop along one side only shall have a minimum clear width of 3'-4" between the countertop front edge and the opposite wall. See Figure 16.1.4.

Kitchens, bedrooms or bathrooms located off a flight of stairs make the housing unit inaccessible to those in wheelchairs and inconvenient for those who walk with difficulty.



U or L shaped kitchen

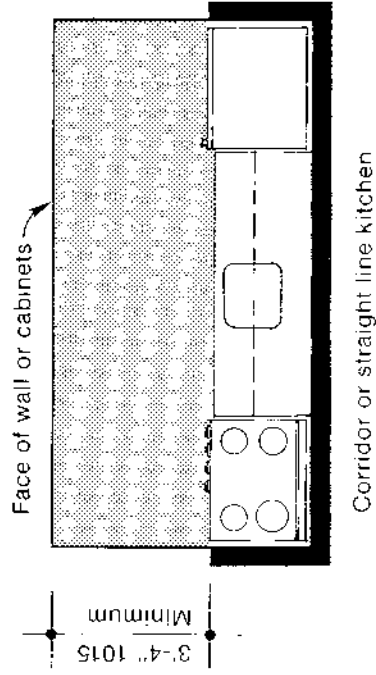


Figure 16.1.4  
Minimum requirements for clear space in kitchens.

Some people find it difficult or impossible to climb into or out of the tub.

#### **16.1.5**

Bathrooms shall be designed so that the door can be closed when a person in a wheelchair is using the room. This can be accomplished by opening the door out, using a sliding or solid folding door, or providing sufficient space in the room to allow an inswinging door to pass the wheelchair. See Figure 16.1.5 for examples of minimum size bathroom layouts which are accessible.

Many people require grab-bars around baths. Many elderly people and those with balance problems need support as the bottom of the tub is often slippery. People in wheelchairs need grab-bars to help them transfer from their chair into the tub and out again.

#### **16.1.6**

Structural reinforcement, where bathroom walls are of stud construction, shall be provided for future installation of grab bars. Grab bars shall be purchased and installed by the resident to meet individual particular needs. Reinforcement shall be provided in each wall adjacent to the tub and/or shower, and water closet and shall be located 2'-10" to the center line of the reinforcing member, see Figure 16.1.5. The reinforcement shall be capable of supporting 250 lbf. load transferred from the grab bar.

Different disability conditions require various accessibility or mobility aids. A unit which could be adapted to serve these varying requirements is an economical method of providing a housing choice to all. Each occupier would select aids to suit his specific needs.

#### **16.1.7**

All hardware shall meet the requirements of Section 4.2, Door Hardware, and all controls shall meet the requirements of Section 14.1, Location of Controls, Dispensers and Receptacles.

### **16.2**

#### **HOTELS, MOTELS**

#### **16.2.1**

All public space in hotels and motels shall be accessible and meet the applicable requirements of this Standard.

Many hotels are inaccessible to those in wheelchairs. Some hotels are accessible only when temporary ramps are put down; bathroom doors are removed, and furniture rearranged.

Some hotels with minimal accessible accommodations have some inaccessible public and service facilities. Such inaccessible facilities include snack bars, restaurants, public toilets, pay telephones, bars, or parking.

When persons in wheelchairs attending conferences stay at the same hotel, they often have to wait long periods for elevators which are too small to accommodate more than one or two wheelchairs, especially when not all elevators serve all floors.

#### **16.2.2**

The doorways to all rooms, including bathroom, shall be a minimum of 2'-8" clear width; see Section 4.1.5, Entrances, Doors and Doorways.

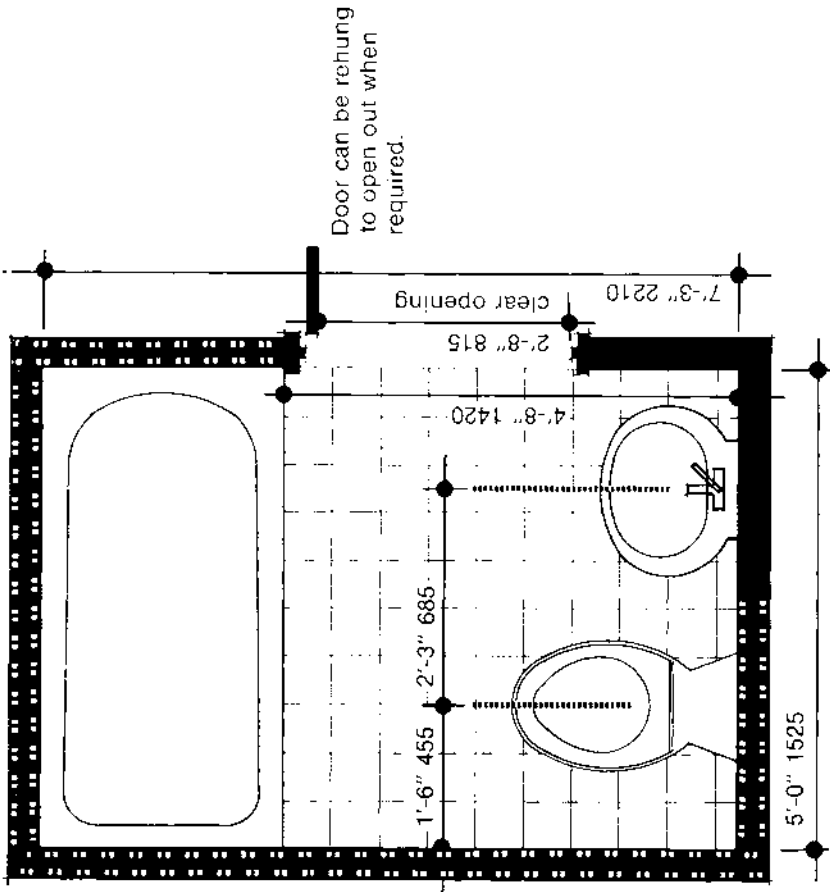
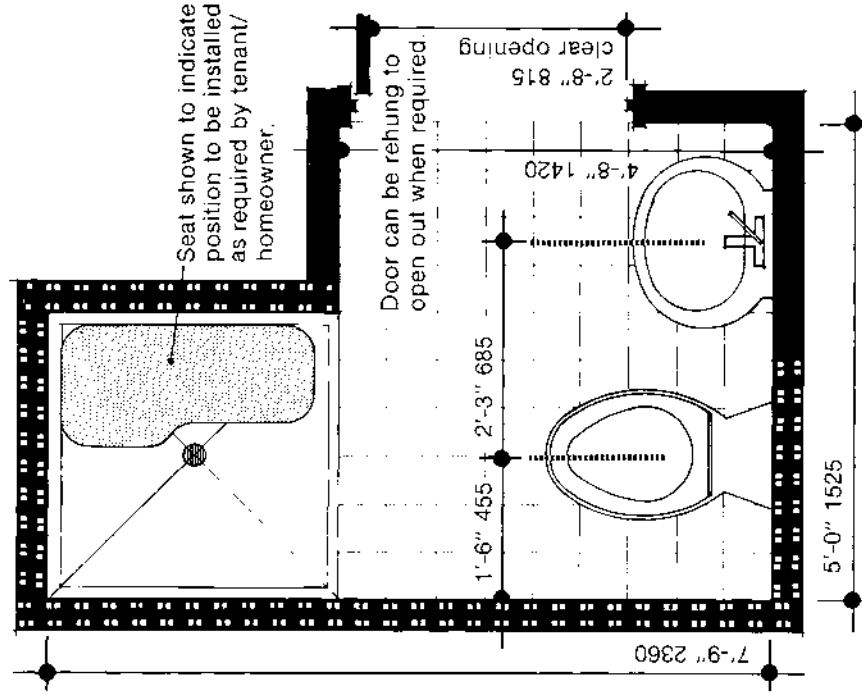


Figure 16.1.5 & 16.1.6  
Examples of minimum size residential bathroom.



Dotted line indicates lengths of wall to have reinforcement to receive grab bars or supports to be supplied by owner/tenant.

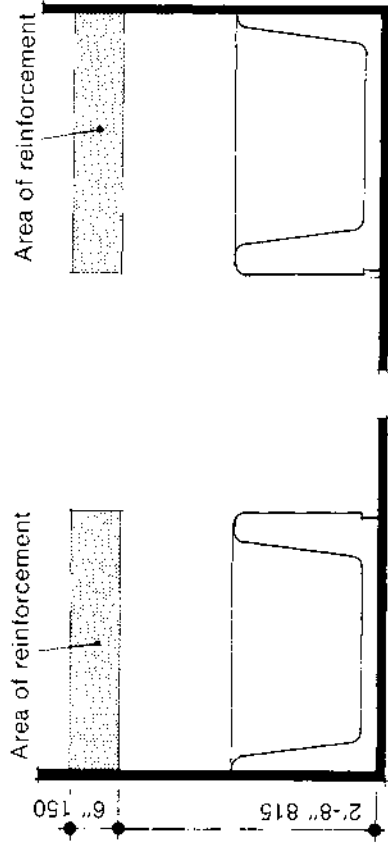
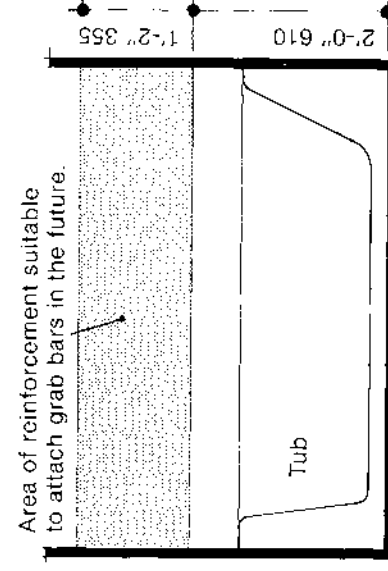


Figure 16.1.6  
Structural reinforcement shall be provided around tub.



**16.2.3**

The number of bedrooms with bathrooms to be fully accessible to handicapped persons in wheelchairs shall be based on Table 16.2.3. This requirement shall apply only to hotels and motels with 20 or more units. In walk-up arrangements the accessible units and spaces used in common shall be located on ground level. In hotels with elevators, the accessible units shall be located close to the elevator.

**TABLE 16.2.3  
Number of Rooms in Hotels and Motels Fully Accessible to those in Wheelchairs**

Total Number of Rooms	Number of Accessible Rooms and/or Suites
0-100	1 for each 25 or fraction thereof
101-200	5
over 200	6, plus 1 for each 100 or fraction thereof over 200

**16.2.4**

Fully accessible bedrooms shall have bathrooms that meet the minimum requirements shown on typical layouts, Figure 16.2.4, including the installation of grab bars.

**16.2.5**

If there are no emergency warning provisions for the deaf, they may be trapped in a hotel fire because they cannot hear the fire alarm bells, the telephone ringing, or knocking on their door by hotel staff giving warning.

A visual emergency warning system shall be provided for use in all sleeping rooms or suites. This system may be a permanent installation in all rooms or may be a portable device provided by the hotel or motel to be installed in a room or suite as needed on request of a deaf person, and shall meet all the requirements of Section 12.2, Emergency Warning Signals and Alarms. At least two portable visual emergency warning devices shall be available.

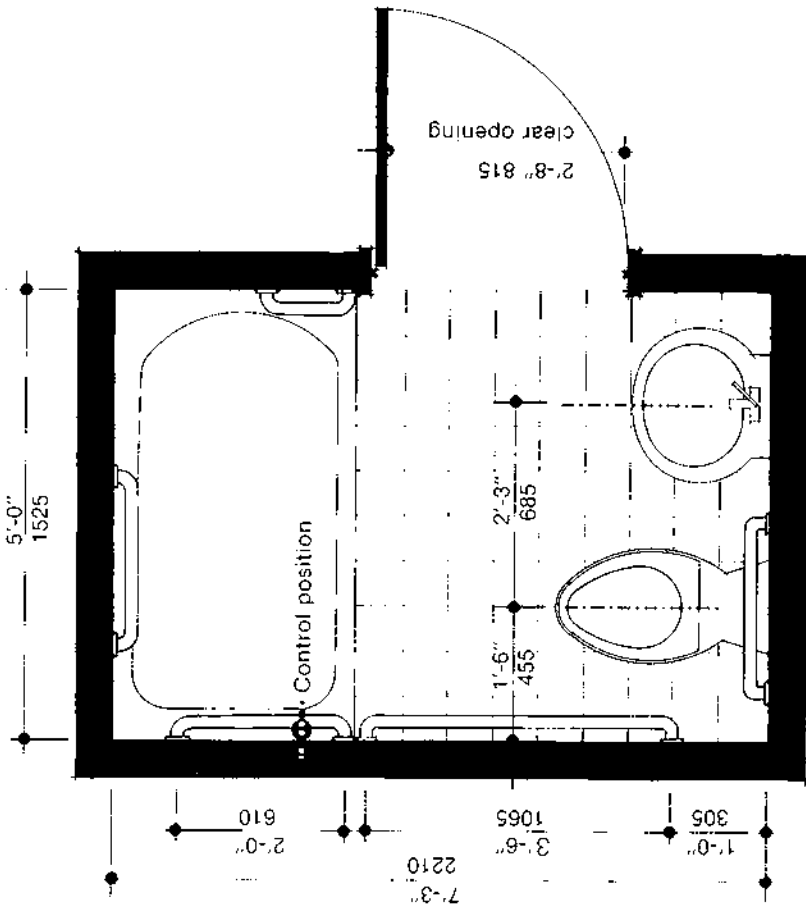


Figure 16.2.4 Example of minimum requirements for a fully accessible bathroom.

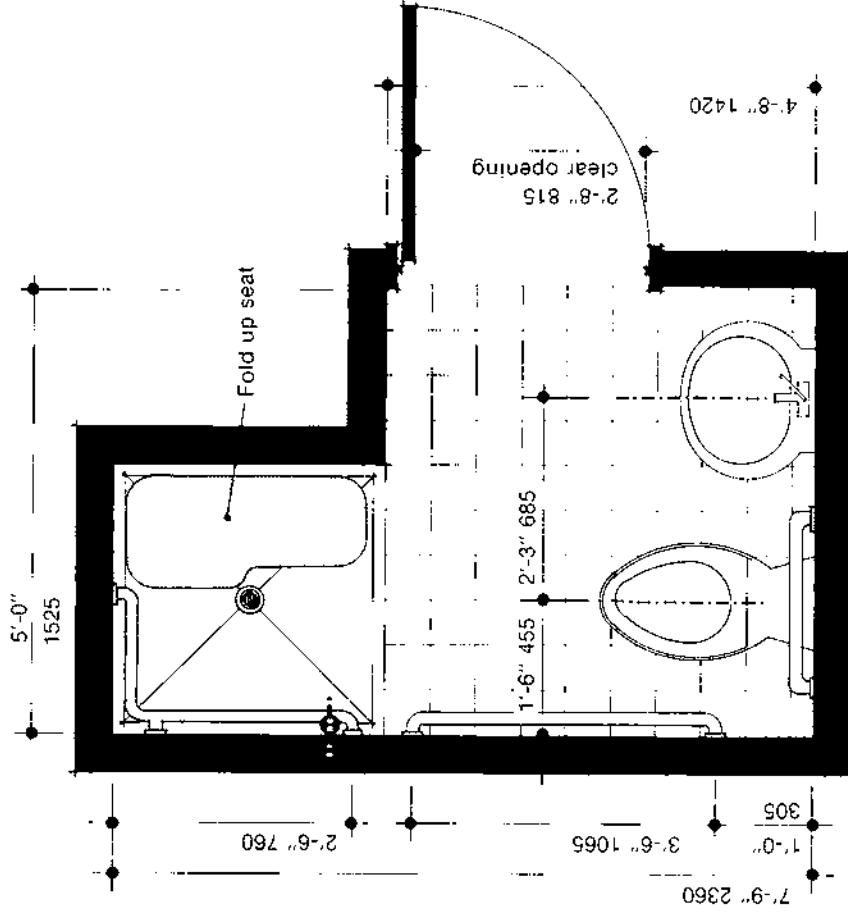


Figure 16.2.4 Example of minimum requirements for a fully accessible bathroom.

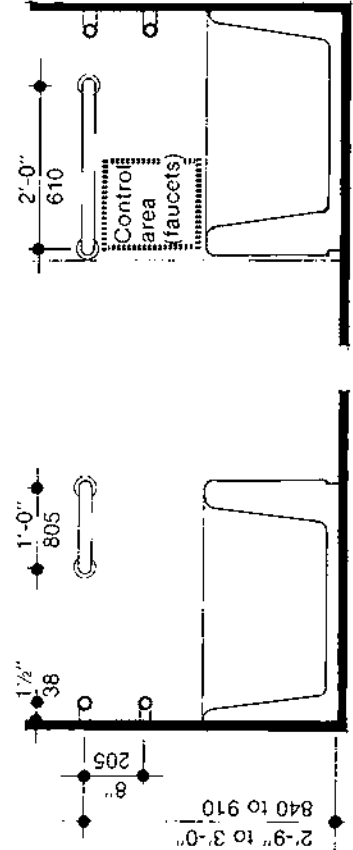
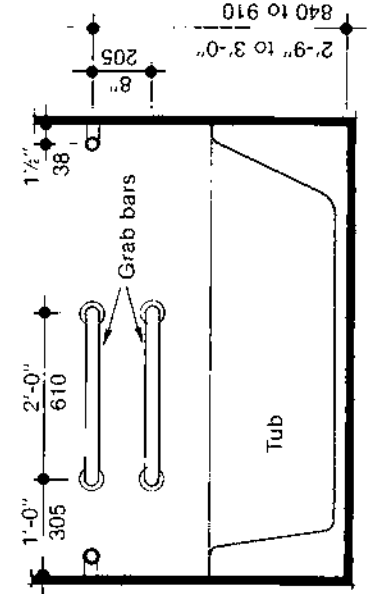


Figure 16.2.4 Location of grab bars in fully accessible bathrooms.





### 16.3

#### EDUCATIONAL BUILDINGS, LIBRARIES AND MUSEUMS

There is a growing tendency towards mainstreaming in elementary and secondary schools, yet many schools remain inaccessible. Mainstreaming means the integration of disabled students into regular public school life.

Disabled persons are restricted in their choice of institutions of higher learning because many of them are inaccessible.

There is often an inadequate selection of courses given at accessible schools and universities, because of a limited curriculum or because not all buildings are accessible.

The stereotyping of disabled people sometimes results in their being concentrated in classes, irrespective of disability.

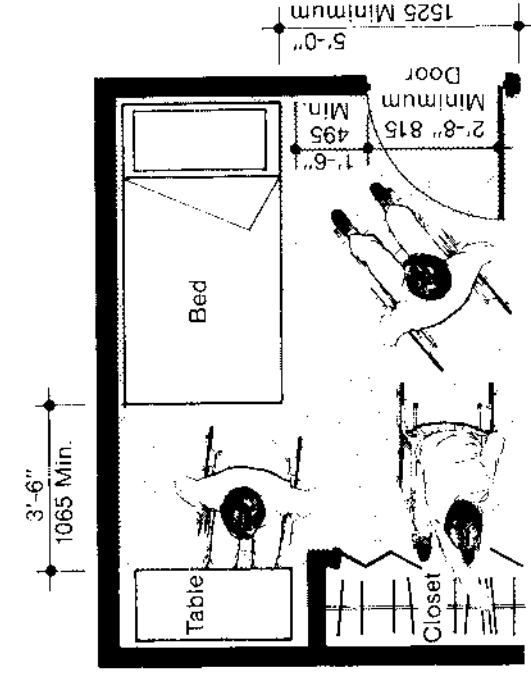
Special schools for the handicapped often do little towards preparing their students for the life ahead. Able-bodied students are denied the opportunity of being exposed to their disabled peers and, thus, preconceptions and prejudices arise. Greater integration would minimize the social problems of the handicapped.

Many handicapped children have to be bussed long distances to schools because nearer schools are inaccessible.

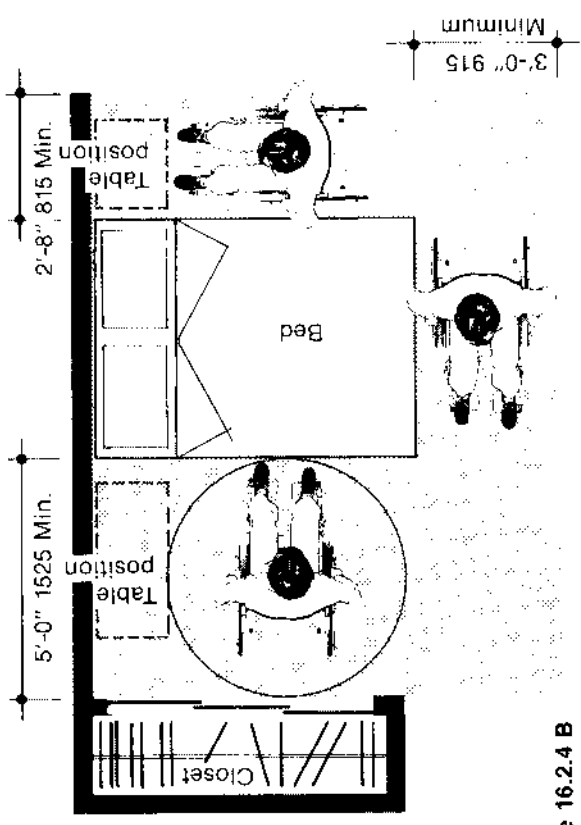
Specialized areas in schools are often inaccessible to disabled students. Such areas include laboratories, gymnasias and changing rooms, special classrooms, etc.

If facilities are intended for use specifically for students which may include disabled users under 12 years of age, the following criteria shall be used:

a. Toilet grab bar size	1½" with 1½" space between grab bar and wall.
b. Toilet grab bar height	mounted 10" above the seat
c. Toilet grab bar length alongside the water closet	3'-0" with 1'-6" length extending beyond the front edge of the water closet.
d. Grab bar must be capable of supporting a 150 lbf. load applied anywhere along the length. Connections must also be capable of supporting a 150 lbf. load.	
e. Toilet height	1'-3" to top of seat from floor surface
f. Lavatory height	2'-5" below apron to floor surface
g. Maximum height of controls receptacles and dispensers	3'-4" from center of operable part to the floor
h. Height of handrails	2'-0" to the center of the bar from the floor surface
i. Height of water fountain spigot	2'-6" from the floor surface
j. Height of telephone to highest operable mechanism	3'-8" from the floor surface



**Figure 16.2.4 A**  
 Minimum space requirements in accessible bedrooms.  
 Single bed



**Figure 16.2.4 B**  
 Double bed



Photo: John Brennan

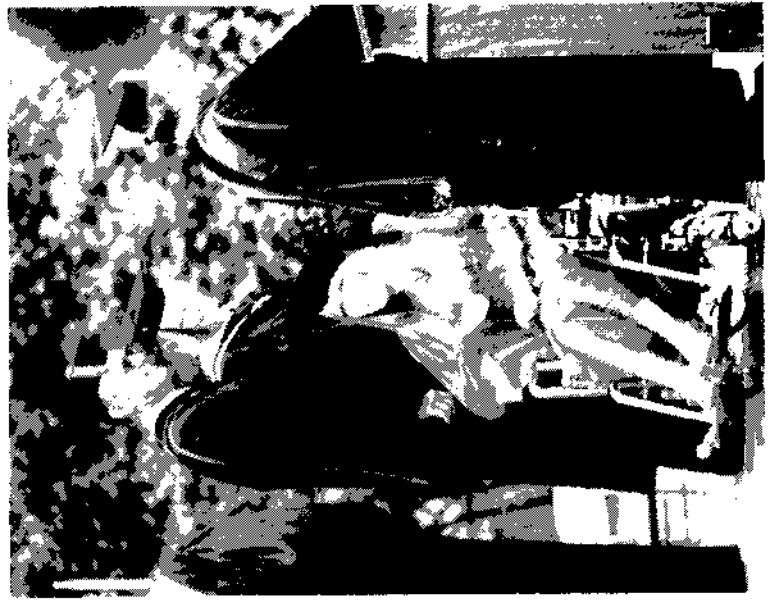


Photo: Ronald L. Mace, Barrier Free Environments

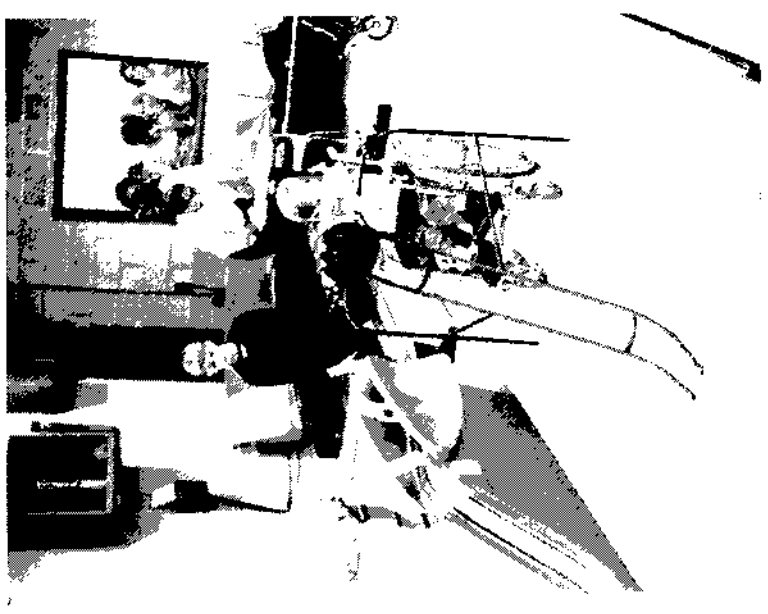


Photo: Illinois Department of Vocational Rehabilitation



The table top is too low and prevents the person from pulling up with the arm rests below the top.

Photo: Mayor's Office for Senior Citizens and the Handicapped, Chicago

**16.3.2** All spaces in educational facilities used by students, faculty and staff shall be accessible and meet the requirements of this Standard.

**16.3.3** Two percent, or a minimum of two lockers in every room where lockers are provided, shall be accessible to people in wheelchairs and shall be located within a range of 9" to 4'-0" from the floor, and have a minimum clear space in front of 3'-6". Accessible circulation routes to the lockers shall comply with Section 2.3.2. Space Requirements for Maneuvering Wheelchairs.

**16.3.4** Where showers are provided, at least one shower for each sex shall be accessible to people in wheelchairs and meet the requirements of Section 10.1, Shower Rooms.

**16.3.5** In laboratories and other work or study areas provided with fixed work countertops, there shall be a hand-capped station having a 2'-6" clear space below the work top extending to the floor. The minimum clear space beneath the hand-capped station shall be 3'-0" wide and 2'-0" deep. The clear aisle width between work tops shall be 3'-0".

**16.3.6** Aisles between fixed stacks in libraries shall be 3'-6" with the exception of existing or remodeled facilities in which aisle spaces are restricted by existing multi-tiered stack structural systems which must be maintained throughout the building.

**16.3.7** When remodeling existing buildings, it may be impossible to make all rooms accessible, but resource rooms, libraries, locker rooms, showers, gymnasias, or other rooms with special equipment shall be made accessible or relocated on an accessible floor. Where specialized rooms, such as science laboratories, are duplicated in a building or facility, at least one room shall be made accessible, unless all the equipment is not available in that room, in which case all rooms required to teach the full course shall be made accessible.

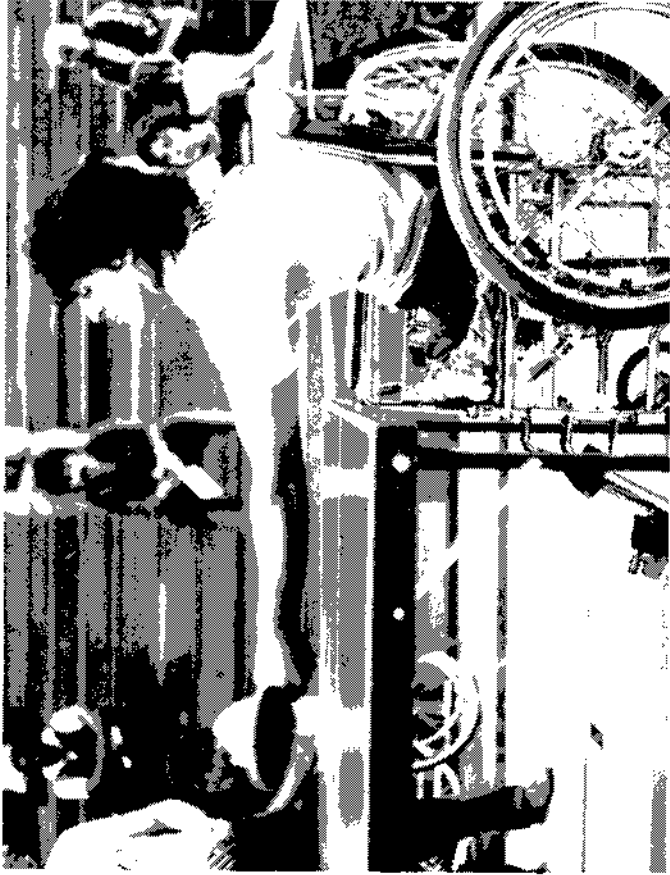


Photo: John Brennan

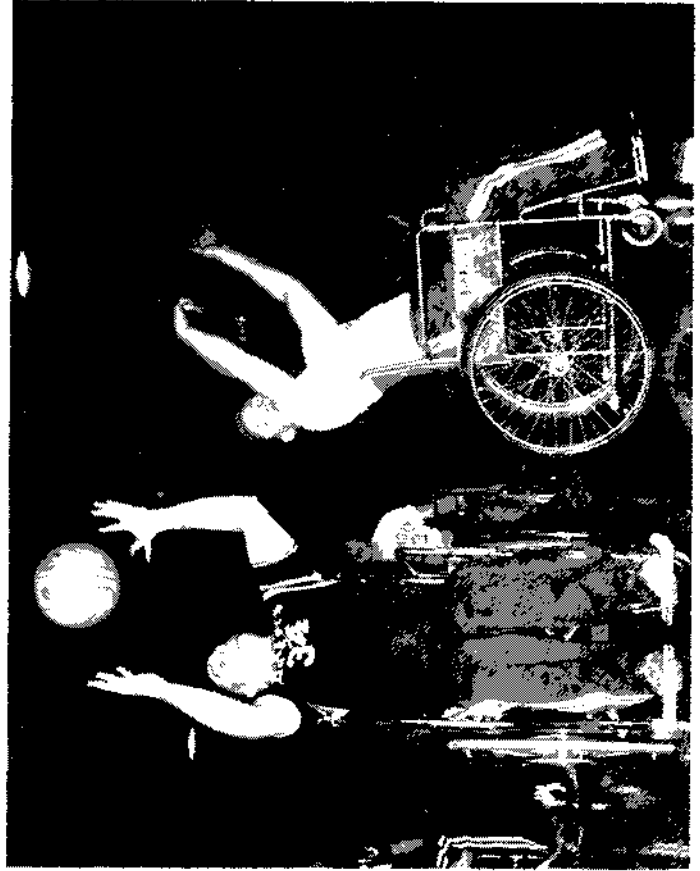


Photo: Trends—July/August/September 1974

Gymnasias and shower rooms will be used by disabled people.

**16.3.8**

In museums every building level with displays open to the public shall be accessible to the handicapped. A reliable information source shall be located adjacent to the main entrance to give audible and visual directions and information for people who have severe auditory or visual impairment. The source should provide full information for use of the facility by the public. Displays shall be designed so that they can be seen by a seated person. See Figure, 16.3.8.

**16.4 HEALTH FACILITIES**

**16.4**

**16.4.1**

All spaces used by visitors and staff shall meet the requirements of this Standard.

**16.4.2**

Where in-patient medical care is provided, all bed rooms and bathrooms shall have minimum clear door openings of 2'-8" , see Section 4.1, Entrances, Doors and Doorways. Five percent (5%) or a minimum of 2 per floor, whichever is the greatest, of patient bedrooms with bathrooms shall be fully accessible to people in wheelchairs. For minimum bathroom requirements see Figure 16.4.2.

**16.4.3**

A visual emergency warning system shall be provided for use in any sleeping room or suite. This system may be a permanent installation in all rooms or may be a portable device provided by the health care facility on request by a deaf person to be installed in a room or suite as needed, and shall meet all the requirements of Section 12.2, Emergency Warning Signal and Alarms.

**16.5**

**TRANSPORTATION TERMINALS AND STATIONS**

**16.5.1**

A reliable information source shall be located immediately adjacent to main entrances of transportation terminals and stations to give visual and audible directions or information to people who have severe visual or auditory impairments. The source may be a directline telephone, intercom or employee. Printed information shall be available also for speech and hearing impaired. The audible and visual source shall provide full information for use of the facility by the public. See Section 12, Communication and Identification.

Transportation remains one of the greatest barriers to an integrated lifestyle for disabled people. Because of the economic restraints put on handicapped people, many of them can only afford public transportation and, if that is inaccessible to them, they have to rely on pedestrian means of travel or travel in cars with friends or attendants. Failing these alternatives, they remain housebound.





Transportation terminals often present a range of problems for all people, including the able-bodied. Long and poorly designed circulation routes confuse or frighten those who are not regular travellers. Distances of pedestrian travel within the terminal are frequently lengthy and exhausting. Public address systems are difficult or impossible to hear, and large volumes, combined with hard surfaces, create acoustical situations that increase the difficulty of hearing and understanding public address systems: Visual directions, signs and information cannot be read by the visually impaired and are often poorly located: Frequently, the facility is not accessible to those in wheelchairs.

### 16.5.2

Where floor plans or maps of the building are at entrances, such plans shall be oriented from the standpoint of the viewer and the viewer's position clearly indicated. It shall also show all vehicle embarkation and disembarkation points, entrances and exits, ticket counters, public lockers, telephones and restrooms. If not all paths of travel or restrooms are accessible the accessible paths of travel and facilities shall be labeled on the map with the International Symbol of Accessibility, see Section 12.1.8.

### 16.5.3

Directions to all areas shall be clearly identified as required by Section 12, Communications and Identification.

### 16.6

#### RECREATION FACILITIES

A handicapped person is often denied the opportunity to participate in recreational activities because they are inaccessible. Such activities include outdoor recreation, sports, camping, fishing, picnicking, nature trails, swimming and boating.

The handicapped population can enjoy the same recreational facilities that are afforded to the whole population.

Many sporting activities take place in inaccessible buildings and the disabled are denied the opportunity of following their favorite sports, either as participants or spectators.





Photo: John Brennan

Given accessible recreational facilities, many disabled people will take advantage of them to the extent that may seem incredible to able-bodied persons. The photographs serve to illustrate this fact.



Photo: Everest & Jennings



Photo: Trends—July/August/September 1974  
Photo: Lloyd Coleman Photography



Photo: John Brennan

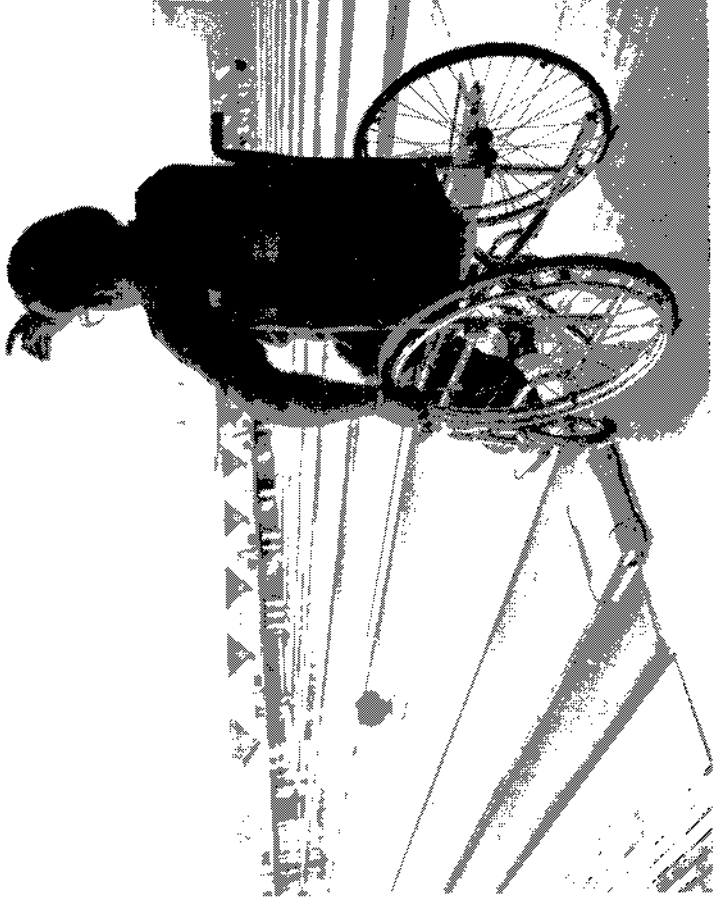


Photo: John Brennan

Basic facilities associated with recreational areas are often inaccessible to disabled persons. These inaccessible facilities include parking areas, curbed sidewalks with no ramps, rest room accommodations, changing rooms and showers, concession stands, etc.

Concession buildings or stands are often located up steps or have doors or aisles which are too narrow to allow wheelchair access.

Many trails have surfaces which are too soft for wheelchair mobility or for those with gait problems.

Many trails do not have rest areas.

The blind have difficulty on trails which do not have adequate cueing devices for canes or which have trees and shrubs which project into the trail but cannot be located with a cane.

Fishing and boating docks are often designed with steps so that wheelchair access is denied. Where access is available, curbs and guardrails are needed so that disabled persons can use the facility in safety.

Picnic tables are often located on soft ground making access to them difficult, or have insufficient space below the top for a person in a wheelchair to sit at them.

Campsites are often located on soft ground.

Barbecues are rarely built so that people in wheelchairs can use them.

Skylifts are generally designed without consideration for the disabled.

Swimming pools and beaches are often inaccessible to those in wheelchairs.

Leaflets, brochures, plaques and signs describing the environment are often designed only for the sighted.

Amusement parks are often designed with little consideration for the disabled.

#### **16.6.1**

Parking lots, toilets, showers, cabins, campsites, concession stands, craft areas, boat docks and other communal areas shall be accessible and meet the requirements of this Standard. Nature trails and paths shall be developed to allow access to people in wheelchairs, those who are semi-ambulatory and those who are visually impaired. Trails over steep or difficult terrain in wilderness areas need not be accessible, but alternate accessible routes shall be provided for the disabled to experience wilderness areas, 5% or at least 2, whichever is the greater, of all camping sites shall be accessible to those in wheelchairs by having a 12'-6" wide parking space and walk which leads to the tent locations and fire-pits, where provided. The parking and path shall be a hard surface and meet the requirements of Section 3.2, Walks and Sidewalks.

#### **16.6.2**

Swimming pools funded with public monies, beaches, zoos, botanical gardens, amusement parks, fairgrounds, bowling alleys, playgrounds, sports facilities, marinas and other recreational facilities shall be accessible to handicapped people. Where provided, all allied facilities, such as parking, horizontal and vertical circulation, entrances, toilet facilities, changing and shower facilities shall meet the specific requirements of this Standard.



Photo: Ken Okinawa



Photo: U.S. Forest Service



Photo: Everest & Jennings

Photo: Trends—July/August/September 1974



Photo: Everest & Jennings

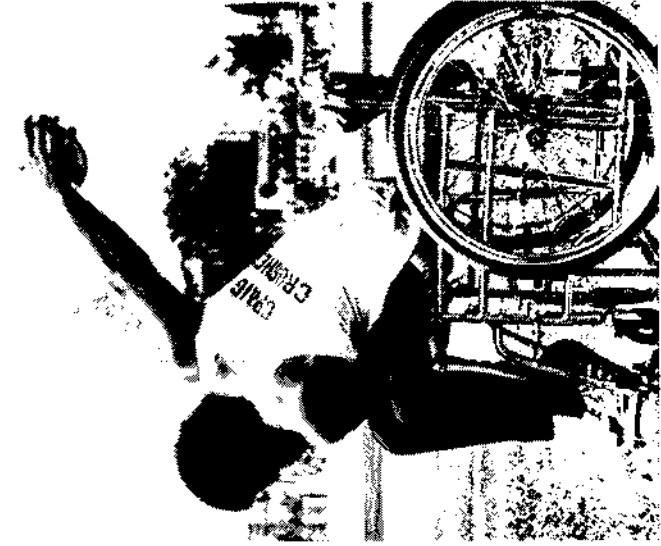


Photo: John Brennan

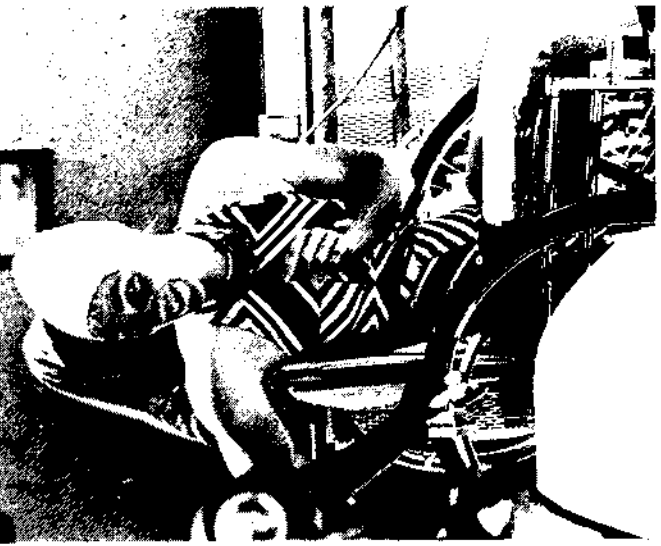


Photo: John Brennan

**16.7 AUDITORIA, ARENAS, ASSEMBLY HALLS, AND STADIA**

In places of assembly with fixed type seating, provisions shall be made for those people who are in wheelchairs, who use crutches and/or walkers, or who are hard of hearing. This includes lobbies, ticket offices, seating, stage, backstage areas, dressing rooms, showers, green rooms, etc.

The minimum number of spectator spaces that shall be accessible to people in wheelchairs shall be computed from Table 16.7.2.

**Table 16.7.2**

**Number of spectator spaces required that are accessible to people in wheelchairs:**

Total number of fixed seats	Number of spaces required
Up to 50	2 spaces for wheelchair users adjacent to each other.
51-400	4 spaces including 2 adjacent to each other.
401 and above	An even number of spaces not less than 1% of total number located throughout seats of all price ranges and locations.

Spaces provided for wheelchair users shall provide sight lines that are equal to those provided for the majority of the audience.

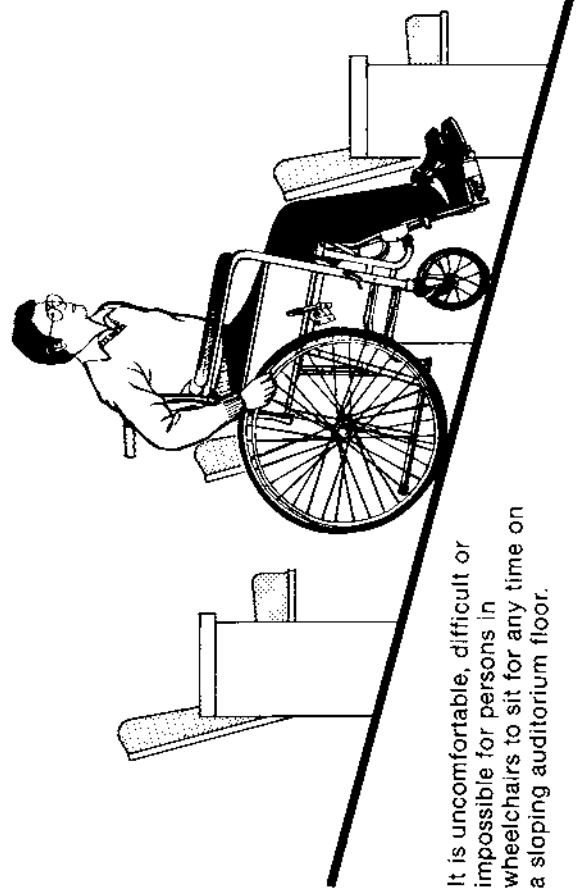
Spaces for wheelchair users shall be level, and the accessible path of travel to them shall meet all requirements of Section 5.1, Interior Circulation Routes. The route to the closest fire exit or horizontal exit shall be an accessible path of travel.

**16.7**

**16.7.1**

There is no provision for people in wheelchairs in most auditoria etc. Where there are accessible routes to the auditorium, the person in a wheelchair frequently has to sit in an aisle where sight lines are not good. A person may not be able to sit with his family if the only place for his wheelchair is in the aisle at the front or rear of the auditorium. He may also be deprived of their companionship if they cannot afford the high-priced seats if this is where the only accessible wheelchair spaces are located. Some theater managers will not allow wheelchairs to occupy aisle positions because the fire exits are blocked. The disabled, thus, are denied entrance.

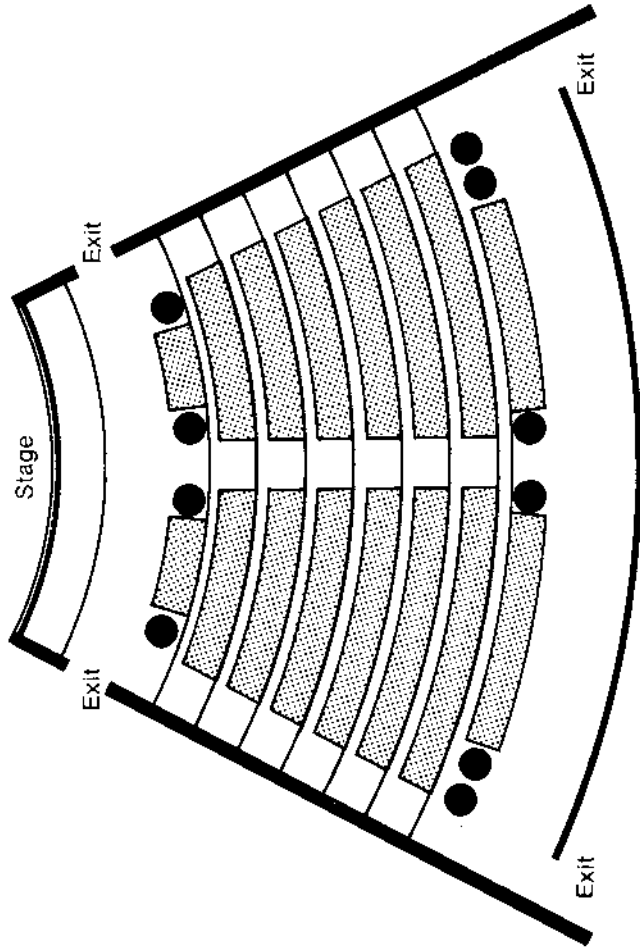
Some auditoria and stadia have been modified for wheelchair accessibility with only one area provided for those in wheelchairs to sit together. Although this provides minimal accessibility, it should not be encouraged as it discriminates against the handicapped who do not have the same choice of seating position offered the able-bodied. It also prevents a disabled person from sitting with friends or family.



It is uncomfortable, difficult or impossible for persons in wheelchairs to sit for any time on a sloping auditorium floor.

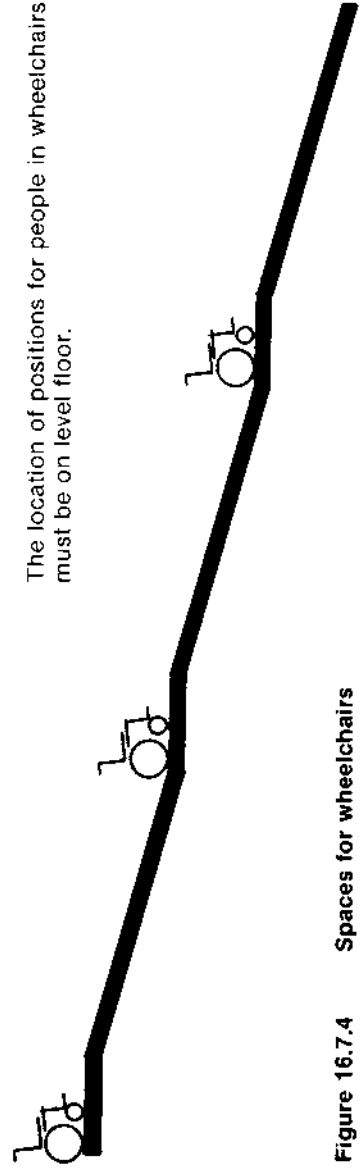
**16.7.3**

**16.7.4**



● Potential location for wheelchair positions. Where the minimum number required is 4 or less, there shall be permanent wheelchair spaces. Above this number removable seating can be installed.

**Figure 16.7.3**  
Places for wheelchairs in auditoria, etc.



The location of positions for people in wheelchairs must be on level floor.

**Figure 16.7.4** Spaces for wheelchairs

**16.7.5**

When more than 4 wheelchair spaces are provided, removable seats can be placed in the wheelchair spaces and removed as required.

**16.7.6**

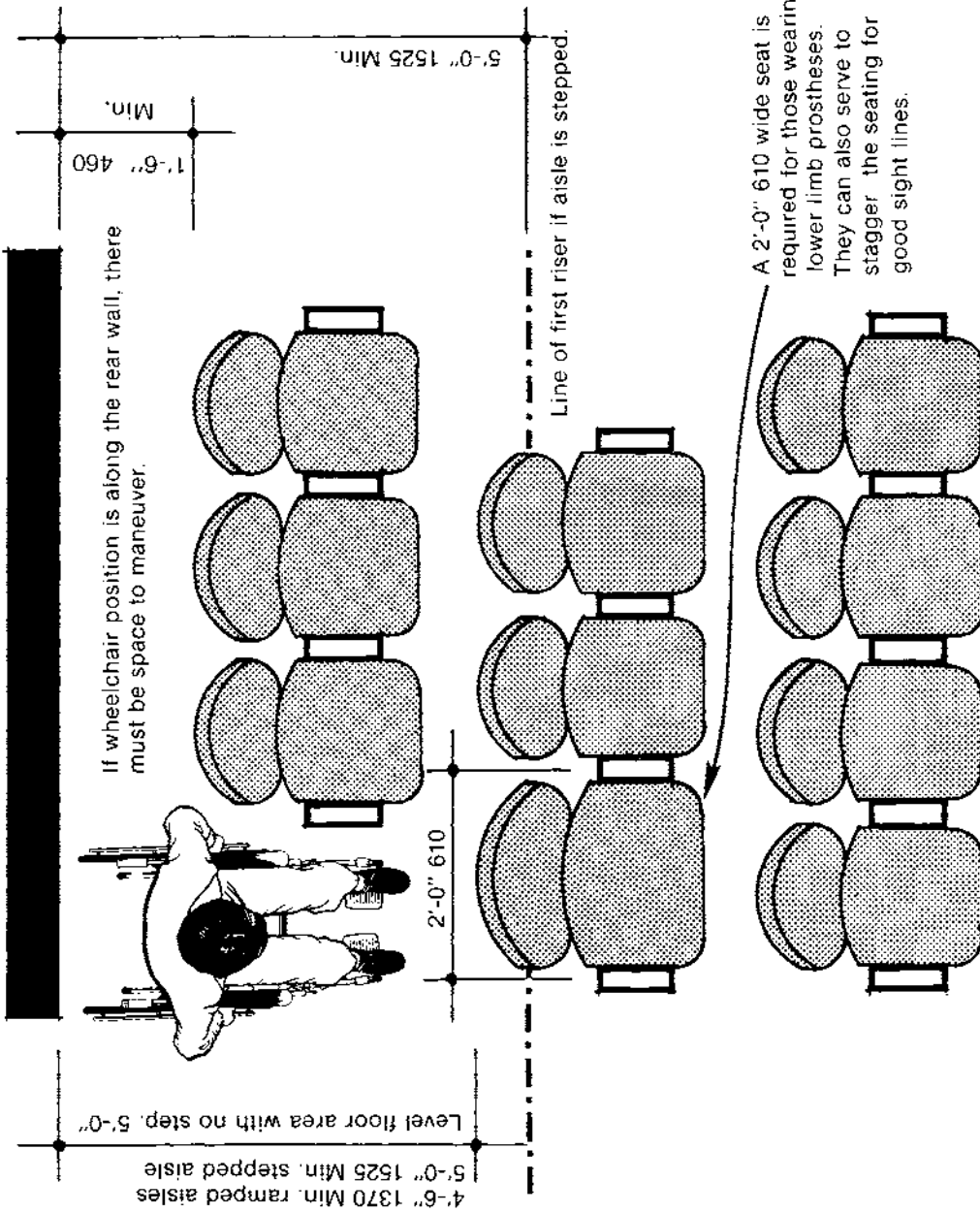
Wider seats with clear leg space are needed throughout the auditorium for those using braces and crutches. While the front row allows ample leg room these seats are usually among the most expensive in the house.

The minimum number of seats at least 2'-0" wide that shall be available for people with orthotics or prosthetics shall be computed from Table 16.7.6. These seats shall be located on the aisles.

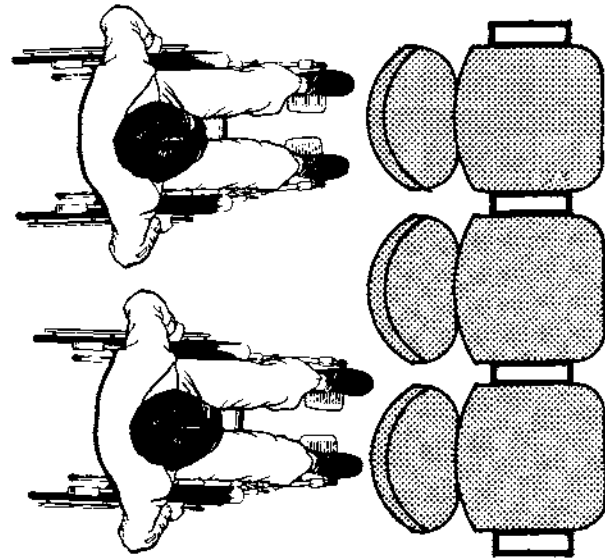
**Table 16.7.6**

**Number of seats 2'-0" wide required for people with crutches and/or braces etc.**

<b>Total number of fixed seats</b>	<b>Number of 2'-0" wide seats required</b>
up to 50	2 seats on the aisle
51-400	4 seats on the aisle
401 and above	An even number of seats not less than 1% of the total number and located on the aisle throughout seats of all price ranges and locations.



A 2'-0" 610 wide seat is required for those wearing lower limb prostheses. They can also serve to stagger the seating for good sight lines.



If removable seats are used, three seats have to be taken away to provide two places for people in wheelchairs.

Figure 16.7 Seating in auditoria, etc.

**16.7.7**

The minimum number of seats provided with a loop, F.M. or other type of listening system shall be computed from Table 16.7.7. These seats shall be located within 50'-0" of the stage or playing area, with a complete view so that people with hearing impairment may enjoy maximum appreciation of audible presentations by seeing facial expressions and lip movement.

**Table 16.7.7**

**Seating required with integral listening system provided for hearing impaired.**

<b>Total number of fixed seats</b>	<b>Number of seats required with a listening system</b>
up to 50	2 seats together within 50'-0" of the stage.
51-400	4 seats in two separate locations within 50'-0" of the stage.
401 and above	An even number of seats not less than 1% of the total number and located throughout seats of all price ranges and locations within 50'-0" of the stage.

**16.8**

**SERVICE COUNTERS**

**16.8.1**

All areas that are used for business transactions shall be accessible.

**16.8.2**

Where service counters exceeding 3'-0" in height are provided for standing counters, an auxiliary counter or other space suitable for the business transaction shall be provided in the immediate vicinity and provide the same services. The auxiliary counter shall not exceed 3'0" in height from the floor, and if required for writing purposes, as in banks, hotels, etc., then space shall be provided to allow a wheelchair to pull up below the counter top and be a minimum of 2'-6" clear to the floor, 2'-8" wide and 2'-0" deep.

Many hearing impaired people could enjoy theatrical productions and lectures if an amplification system were provided in various seats of the house. Some theaters have seats that are so far back from the stage that the hearing impaired cannot see facial expressions and lip movements, which add to the comprehension of the action. The inability to perceive facial expression removes much of the enjoyment of 'live' theater.

Counters in hotel lobbies, book return counters in libraries, service counters in banks and ticket counters are often too high for a small person, or a person in a wheelchair to transact his business.





Self-service food counters are often too high to be used by those in wheelchairs, or the aisle alongside is not wide enough for a wheelchair or has a right-angle turn in it that cannot be negotiated. Sometimes the cashier is inconveniently located, preventing a person in a wheelchair from leaving the line.

**16.8.3** Cafeteria lines shall meet the applicable requirements of Section 5.1, Interior Circulation Routes. In addition, the height of counters for conveying trays shall be 3'-0" maximum, and the maximum reach to any dispenser shall be within reach limitations of wheelchair users unless employees are behind the cafeteria line at all times. See Figure 16.8.3.

**16.8.4** The clear width of the circulation space paralleling service counters shall be a minimum of 2'-8".

**16.8.5** Food shall be located at a maximum of 1'-8" from the edge of the counter.

**16.8.6** Entry control devices shall not prevent access by handicapped persons. When turnstiles or narrow gates are required, alternate access shall be provided immediately adjacent the turnstile.

## **16.9 DINING HALLS – RESTAURANTS**

Many restaurants are inaccessible. The main complaints are steps at the entrance, changes of level inside the restaurant accessible only by steps, tables positioned too close together to allow wheelchair access, and inaccessible toilet facilities. When the main entrance is inaccessible, nothing is less desirable than entering a restaurant through the service area where garbage cans are stored, or through the kitchen, where food is in various stages of preparation. For many persons in wheelchairs, access through these areas is the only possible way of achieving an evening of dining out and entertainment.

**16.9.1** Dining facilities shall meet all applicable requirements of the Standard including parking, toilets, circulation, elevators, etc.

**16.9.2** Tables shall have a minimum of 2'-6" clearance under the table top to the floor surface.

**16.9.3** The clear width between fixed chairs shall be a minimum of 3'-0".

Microwave ovens can interfere with the operation of heart pacemakers.

**16.9.4** Where microwave ovens are installed, notices shall be posted to warn, in advance, the possible hazard to those persons with heart pacemakers. See Figure 16.9.4.

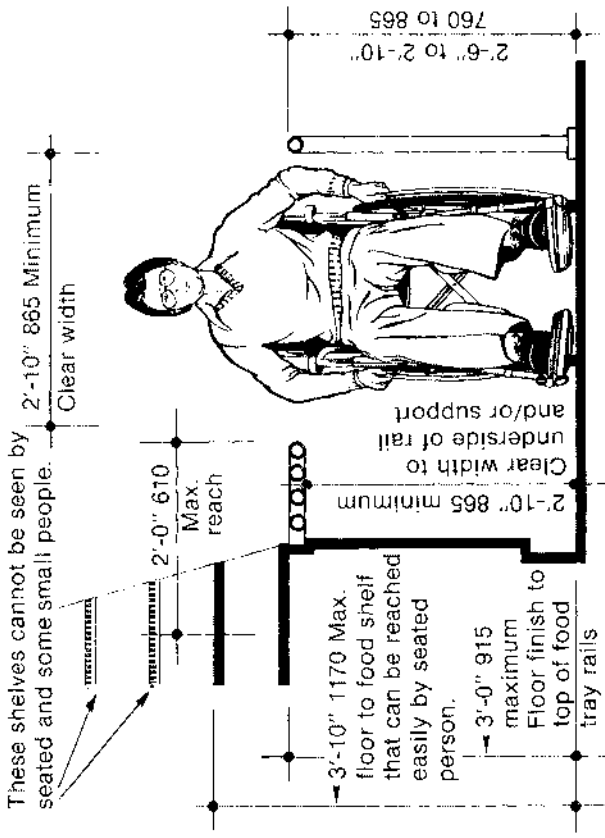


Figure 16.8.3  
Cafeteria lines



This pleasant outside dining space is accessible. The central pedestal of the table, however, prevents the person in the wheelchair from being able to use the table top. The pedestal also restricts the foot space below the table for anyone.

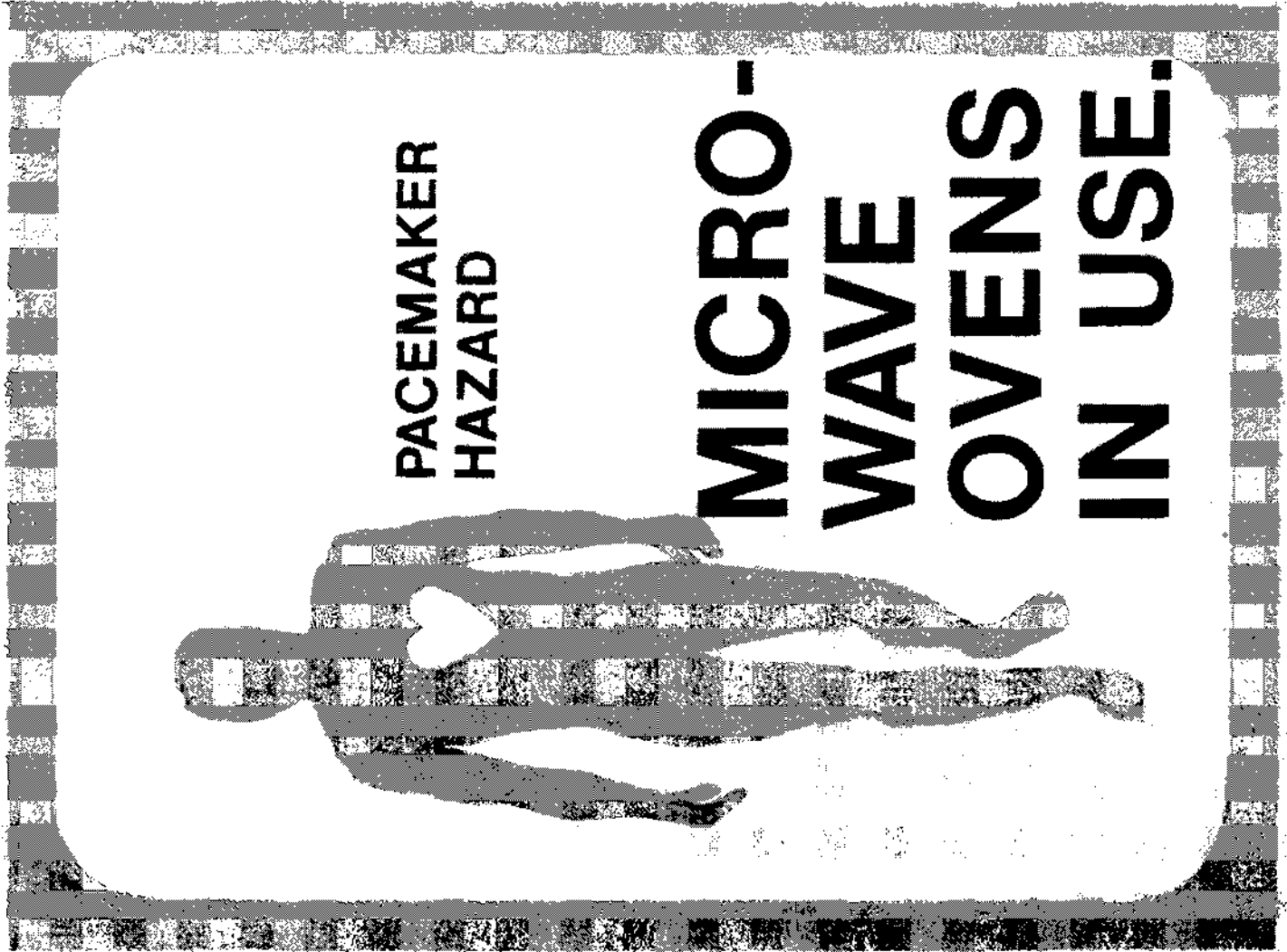


Figure 16.9.4 Example of sign with microwave oven warning

**16.9.5**

In restaurants where there are mezzanine levels, loggias, or raised platforms, accessibility to all spaces is not required providing the same services and decorative character are provided in spaces located on accessible paths of travel.

**16.10**

**SHOPPING CENTERS – GROCERY STORES**

**16.10.1**

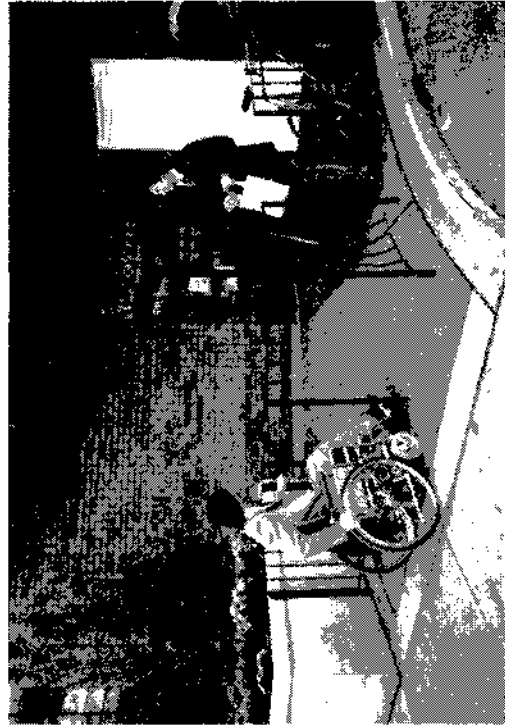
There shall be at least one check-out point accessible to the handicapped in a wheelchair in all shops, stores, etc., having check-out aisles, and shall have 2'-8" minimum clear aisle width, and 3'-0" maximum height of the counter from the floor.

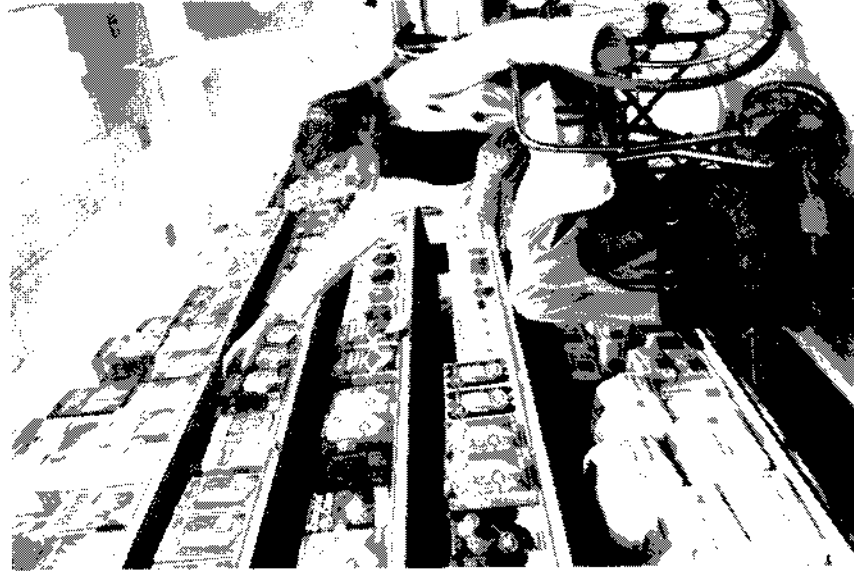
**16.10.2**

Any device used by stores to prevent shopping carts from leaving the premises shall not prevent access or egress to those in wheelchairs. An alternate entrance equally convenient to that provided for the ambulatory population is acceptable.

Some grocery stores have barriers to prevent shopping carts from being stolen. However, these barriers also prevent wheelchair access to the store and inadvertently discriminate against the disabled shopper.

Barriers which restrict the removal of shopping carts often prevent independent access to those in wheelchairs.





Once inside, most grocery stores are accessible, though some products may be on shelves that are out of reach.

Buildings which have been remodeled have often failed to meet handicapped code requirements.

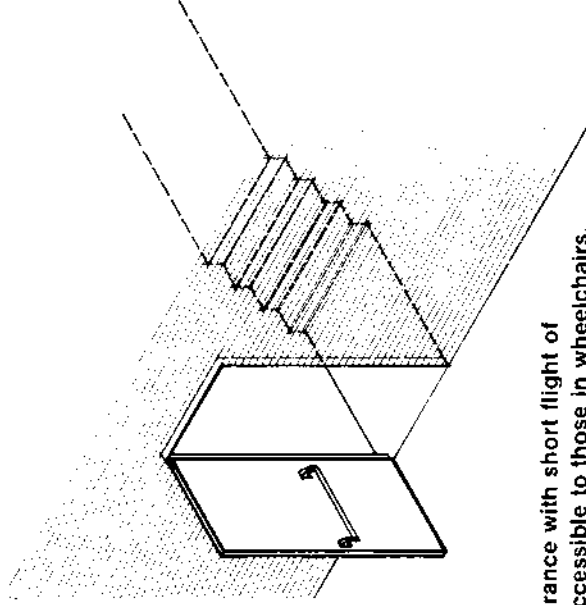
## REMODELING

### 17.1

Remodeling embraces rehabilitation and renovation of existing buildings, including improvements, extensions, repairs, structural alteration, changes in design or layout, or changes in the occupancy of the building. Maintenance, redecoration, changes to the mechanical system, reroofing, or changes to interior landscaping shall not be included under remodeling requirements. The accessibility requirements shall be based on the amount of remodeling carried out and shall be determined by calculating the amount of interior floor area to undergo remodeling expressed as a percentage of the total interior square footage of the building.

#### 17.1.1

##### Problem



Existing entrance with short flight of stairs is inaccessible to those in wheelchairs.

**Solution**

Cut new opening and raise the existing door and frame

Previous head of door

Fill stairwell and continue existing upper floor level through doorway to form landing at top of new ramp.

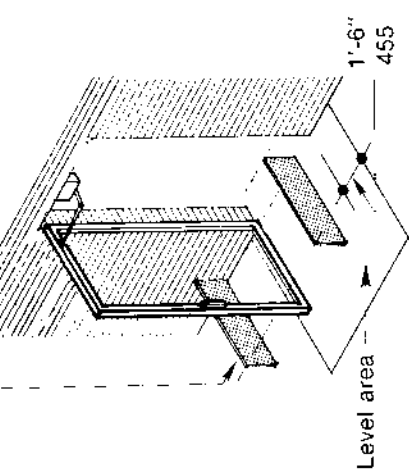
Handrail

New ramp 1:12 slope

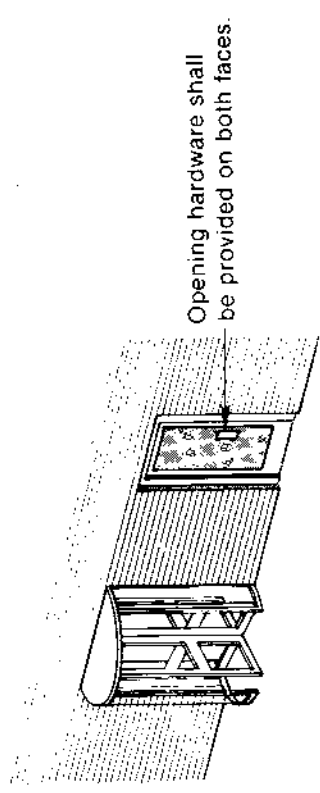
Handrail

Method of providing wheelchair access at existing entrance with short flight of stairs.

At the accessible entrance/s 10" high wood or metal kick plates must be added to existing doors with narrow bottom rail.



Glazed entrance with narrow frame requires kick plates.



Revolving doors must be accompanied by at least one swing door with 2'-8" clear opening and be operable during regular business hours.

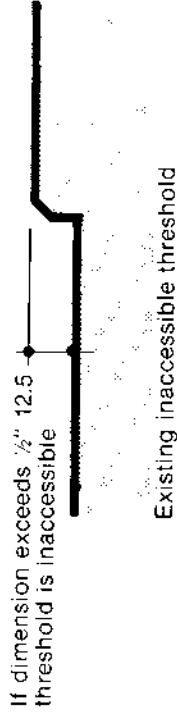
If more than 50% of the interior square footage of a public building is to undergo remodeling, the entire building, including site requirements, shall conform to these Standards, to the extent shown in Table 17.1.2.

**Table 17.1.2**

**When more than 50% of the interior square footage of the building is to be remodeled:**

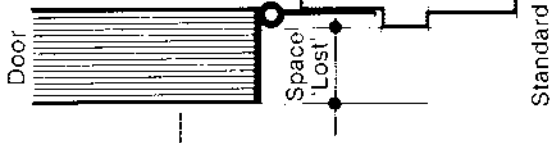
- a. At least one accessible path of travel from a site access point to an accessible entrance or entrances (if there are several different functions occurring) shall be provided.
- b. At least one accessible entrance to the building, or one accessible entrance to each function in the building where several different functions occur, shall be provided. For example, a concert hall and art gallery occurring in the same building shall have separate entrances serving each space.
- c. An accessible interior circulation route to and into all publicly used spaces shall be provided. This includes horizontal and vertical circulation used by visitors and employees.
- d. At least one accessible toilet for each sex on each floor shall be required for visitors and employees, where toilets are provided.
- e. Accessible parking places and an accessible path of travel from the parking place to the accessible entrance shall be required, where parking is provided. The number and requirements for places for disabled drivers shall conform to Section 3.5, Parking.
- f. If hardware, controls, dispensers, receptacles, stairs or other features of the building included in this Standard, but not required under Section 17.1.2a through Section 17.1.2e, are to be replaced or altered, then the requirements of the specific section of this Standard shall be followed.

**Door Thresholds                      Problem**



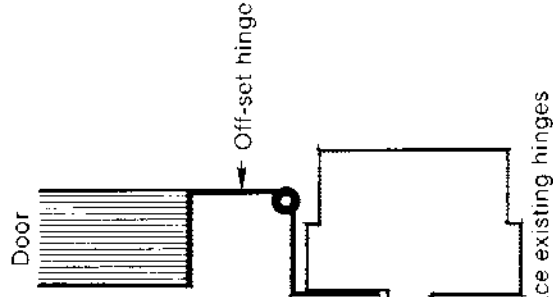


**Problem**



Clear door opening measured from face

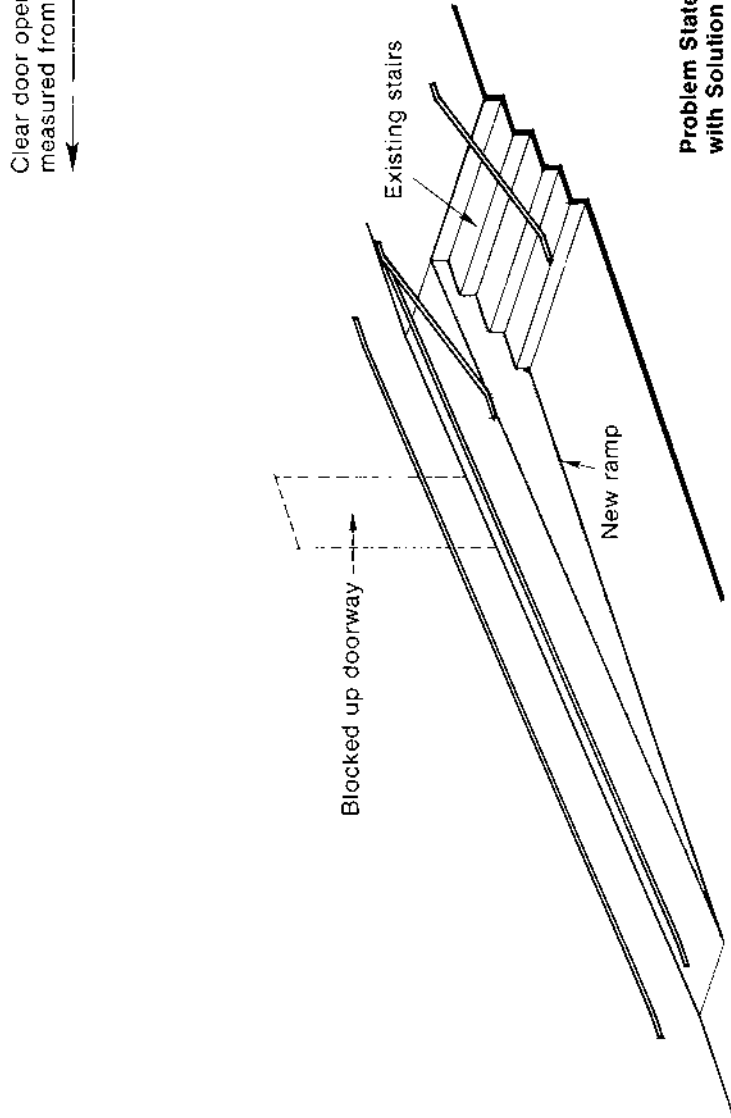
**Solution**



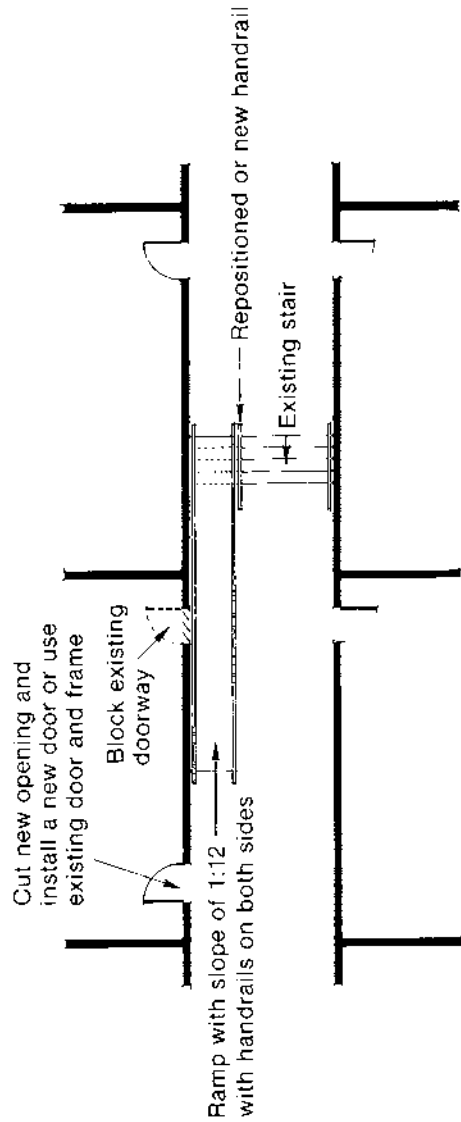
Clear door opening now measured from face of stop

Replace existing hinges with off-set hinges

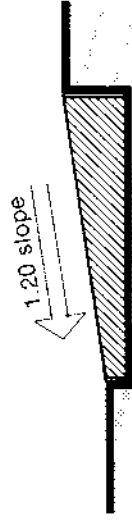
An acceptable accessible doorway may be achieved by changing the hinges.



**Problem Statement with Solution**



Addition of a ramp in an existing corridor with stairs



**Alternative A.**

Existing threshold removed and new sloping threshold constructed.



**Alternative B.**

Existing threshold remains but an addition to the threshold is constructed across the whole width.

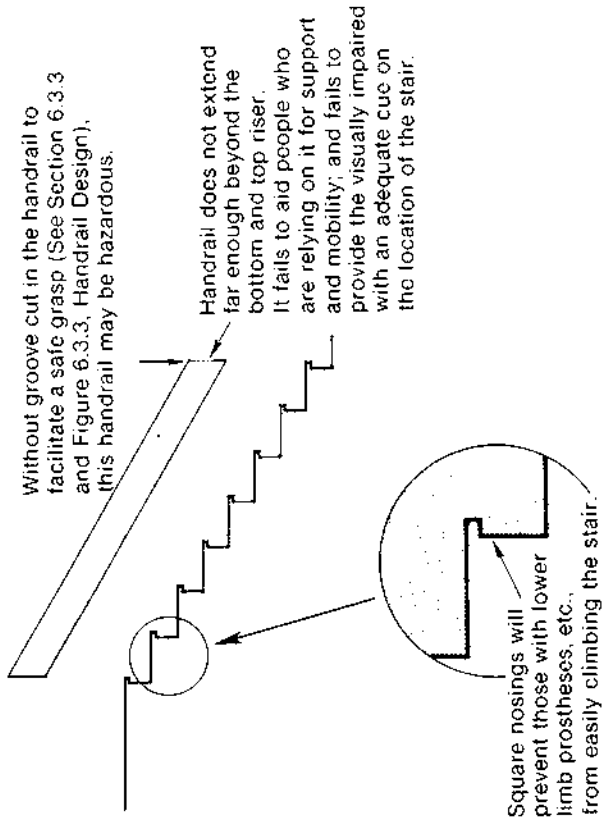
17.1.3

If 25% to 50% of the interior square footage of a public building is to undergo remodeling, that part of the building which is to be remodeled shall conform to these Standards, to the extent shown in Table 17.1.3.

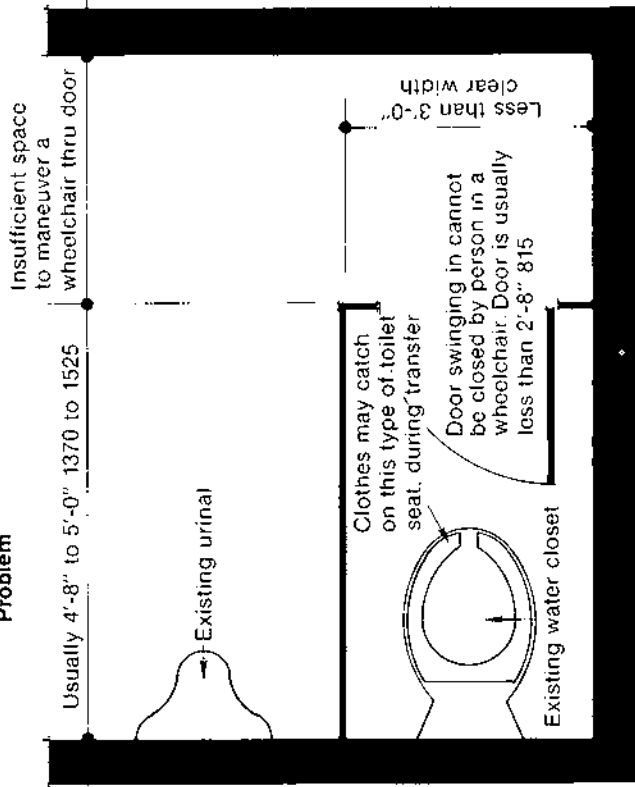
**Table 17.1.3**

**When 25% to 50% of the interior square footage of the building is to be remodeled:**

- a. At least one accessible path of travel from a site access point to an accessible entrance shall be provided.
- b. At least one accessible entrance which is used by the public, but shall not be an entrance used for servicing the building, shall be provided.
- c. Accessible horizontal paths of travel to and into all publicly-used spaces within the space to be remodeled shall be provided. If the building has elevators, the controls in these elevators shall meet the requirements of Section 7.1. Elevators, and have accessible paths of travel from the lobby to the areas that are to be remodeled.
- d. At least one accessible toilet for each sex shall be required for visitors and employees where toilets are provided. In buildings over 4 floors, there shall be one accessible toilet for each sex for every four floors. These toilets shall be on accessible paths of travel from the elevator lobby and shall be marked with the International Symbol of Accessibility on the corridor side of the door.
- e. Accessible parking places and an accessible path of travel from the parking places to the accessible entrance shall be required where parking is provided. The number and requirements for places for disabled drivers shall conform to Section 3.5, Parking.
- f. If hardware, controls, dispensers, receptacles, stairs or other features of the building included in this Standard, but not included under 17.1.3a through 17.1.3e, are to be replaced or altered, then the requirements of the specific section in this Standard shall be followed.

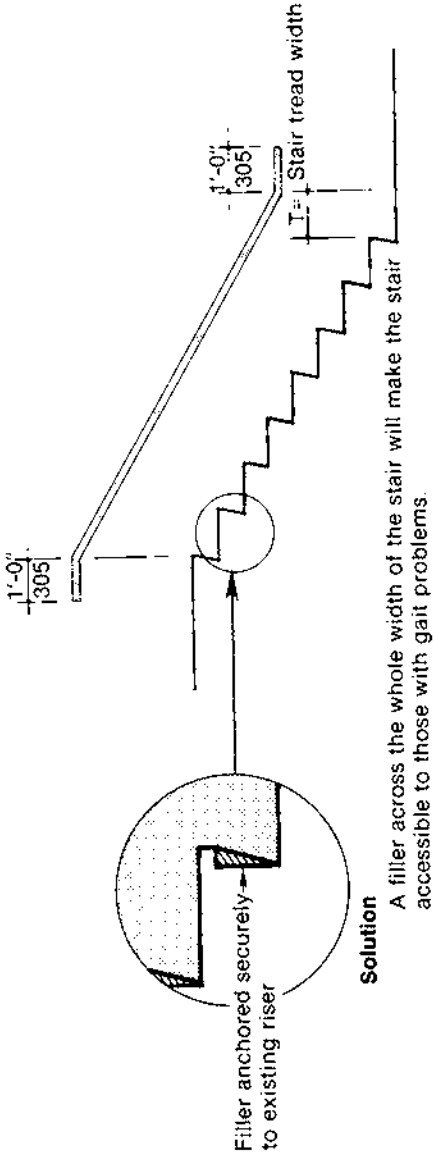


**Problem**

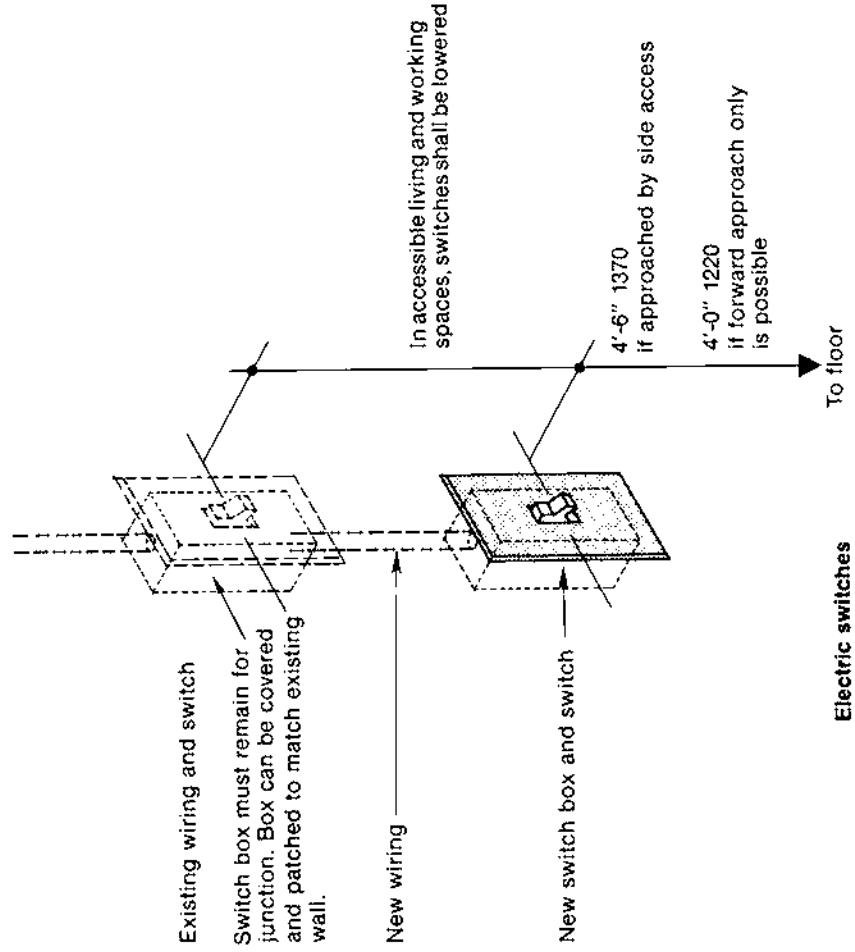
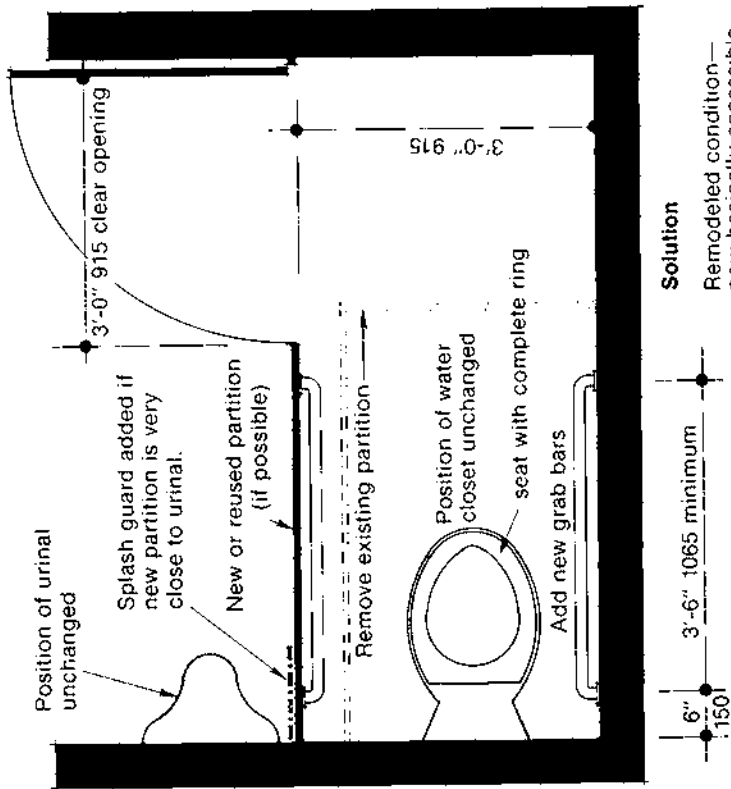


**Problem**

Existing condition—  
inaccessible



**Problem Statement with Solution**



**Minimum requirements for accessible water closet where only one water closet is provided. Adding a new facility is the alternative solution.**

**Electric switches**

#### 17.1.4

If less than 25% of the interior square footage of a public building is to be remodeled, the building shall be made basically accessible, and conform to these Standards to the extent shown in Table 17.1.4.

##### Table 17.1.4

#### **When less than 25% of the interior square footage of the building is to be remodeled:**

- a. At least one accessible path of travel from a site access point to an accessible entrance shall be provided.
- b. At least one accessible entrance which is used by the public, but shall not be an entrance used exclusively for servicing the building, shall be provided.
- c. At least one accessible toilet for each sex in the building off an accessible path of travel shall be required, if toilets are provided.
- d. If hardware, controls, dispensers, receptacles, stairs or other features of the building included in this Standard but not included under Section 17.1.4a through Section 17.1.4c, are to be replaced or altered, then the requirements of the specific sections in this Standard shall be followed.

#### 17.1.5

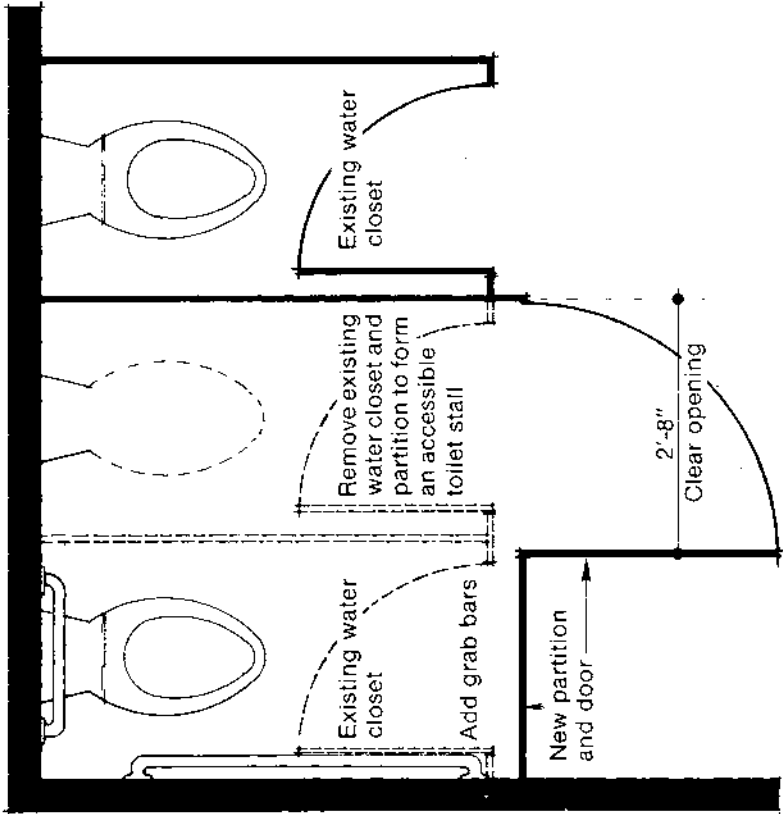
When remodeling is carried out in phases, the completed remodeling square footage shall be used to calculate the requirements of this standard, irrespective of the number of phases needed to complete the remodeling.

#### 17.1.6

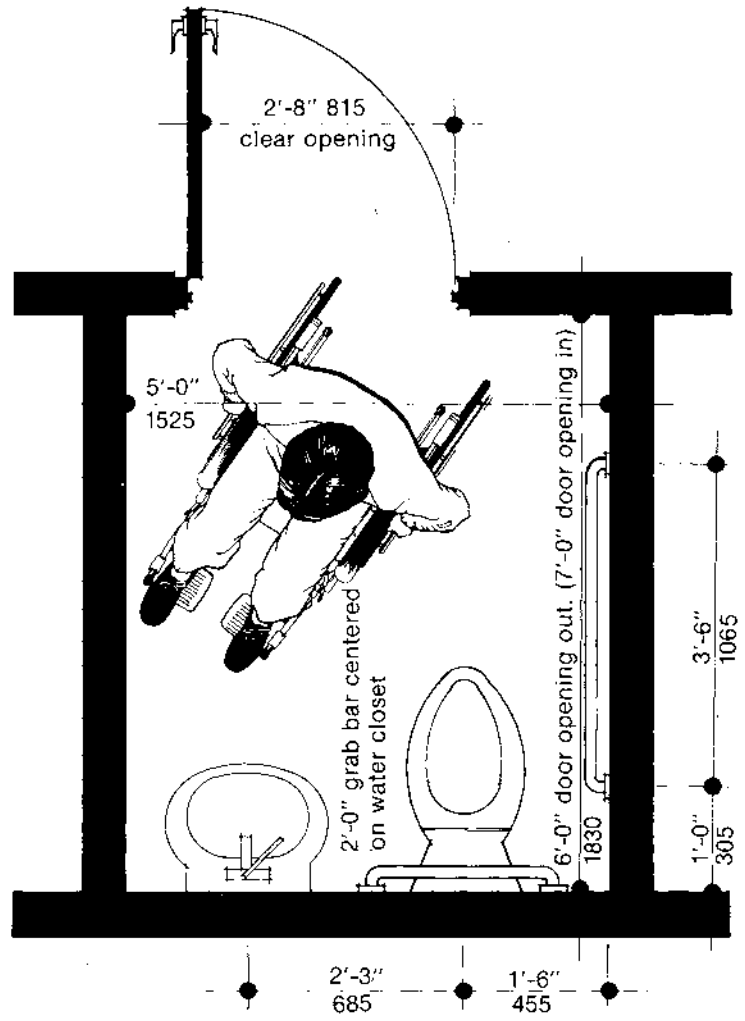
Doors which open into hazardous areas horizontal fire exits or fire stairs shall have knurled or textured openers, see Section 12.2.3, Emergency Warning Signals and Alarms.

#### 17.1.7

When changes of occupancy (classification) occur to an existing building or facility, it shall be made accessible to handicapped people, even though other remodeling or renovation may not take place. Table 17.1.3 shall be followed for the minimum requirements.



Where existing toilet stalls are too small, combine 2 stalls to form the accessible toilet.



Minimum requirements for toilet room with water closet and lavatory.

## HISTORIC PRESERVATION AND HISTORIC RECONSTRUCTION

Many historic buildings have been preserved using public funding. Disabled people pay taxes along with the rest of society, and their needs must be considered when historic and cultural facilities receive grants from local, state and federal agencies.

Frequently accessibility is not included in historic preservation because it is said that the aesthetic integrity of the building will suffer. Yet in the same buildings protective railings are often used to prevent full entrance to rooms. These take away from the aesthetic integrity in a much more severe manner than providing ramp access at the rear of the building for the handicapped.

Many buildings of historic interest are inaccessible to those in wheelchairs because of stepped entrances or doors which are too narrow.

### 18.1

Historic preservation and historic reconstruction projects shall be made at least basically accessible to afford disabled persons the opportunity of experiencing their cultural heritage.

#### 18.1.1

Historic preservation and reconstruction projects that will be open to the public shall meet the following requirements.

- a. At least one accessible path of travel from a site access point to an accessible entrance shall be provided.
- b. At least one accessible entrance which is used by the public, but shall not be an entrance used exclusively for servicing the building, shall be provided.
- c. At least one accessible toilet for each sex, if toilets are provided for visitors use, contiguous to an accessible path of travel shall be provided.
- d. Accessible paths of travel from an accessible entrance to all publicly used spaces at least on the level of accessible entrances shall be provided.
- e. Accessible parking spaces shall be provided, if parking is provided, and an accessible path of travel from such parking spaces to an accessible entrance shall be available.
- f. Displays and written information documents, etc. shall be located where they can be seen by a seated person. Exhibits and signage displayed horizontally e.g., books, shall be no longer than 3'-8" from the floor surface. see Figure 18.1.1f.
- g. Where written descriptive information is provided on the contents or layout of the exhibit area, braille and/or audible equivalents should be provided.



Photo: Chicago Historical Society

Curb ramps are not a late twentieth century invention. This lithograph published in 1866 shows the view east from Clark and Randolph Street, Chicago, and the curb ramps are clearly being used by pedestrians.





## ADVISORY PANELS

Michael A. Jones, ARIBA  
 Chairman for each Advisory Panel  
 Barbara A. Westbrook, Secretary for each Panel

### Consumer Expert Advisory Panel

Name	Representing
Mildred L. Holland Kathleen Weger Frank F. Harimija	Walks with difficulty without aid
Bette Hagglund Harold V. Hopkins, Jr.	Walks with difficulty with aid
Roland Albert John H. Catlin Patrick M. Vaughan	Confined to wheelchair – lower limb involvement
Catherine R. Condon Jack K. Genskow, Ph.D. Thomas R. Schworfes	Confined to wheelchair – upper and lower limb involvement
August W. Christmann Thomas A. Krause	Upper limb impairment
Hiram Zayas	Extremes of Size and/or maturity
Stephen Hastalis William R. Lengbauer	Severe Visual impairment
Robert Barnhart	Deaf/Blind
John B. Davis Frank B. Sullivan	Severe hearing and speech impairment
Laura Abernathy	Problems of Mental Equilibrium
Margaret A. Hayes Ernest H. Mayes	Reduced Stamina, Agility and Reaction Time: the Elderly

### Professional Technical Advisory Panel\*

Edward H. Matthei, AIA Hem C. Gupta, P.E. Ralph C. Hahn, P.E. Don Halamka Phil Dressler Joseph Stein, P.E. George A. Darrell, AIA Theodore Gregory, AIA Joseph A. Downey, C.P.M. Lawrence J. Thomas Battalion Chief William Rose Professor Day Ding, AIA Joseph Michelotti Jon D. Anderson, AIA Rita McGaughey Silas P. Singh, Ph.D.	Architects Electrical/Mechanical Engineers Civil Engineers Planners Builders Construction Industry Developers Transportation Owners Mortgage Bankers Fire Marshals Academia Attorney State Codes National Codes Consumers
Stephen R. Cotler, R.A. Ezra D. Ehrenkrantz, FAIA Peter L. Lassen Ronald L. Mace, AIA John A. Tempier, Ph.D. Dianne Walters	New York State Standards GSA Standards Architectural & Transportation Barriers Compliance Board, Washington, D.C. North Carolina State Standards Pedestrian Research Lab, Georgia Tech. GSA Standards

### Code Advisory Panel

\*Participation on the Professional Technical Advisory Board does not imply endorsement by the advisors on every aspect of these Standards

## THE LAW AND THE HANDICAPPED

The following is intended as a reference to the rights of handicapped people, as established by Federal and State of Illinois legislation, and only as it relates to the physical environment. This appendix does not cover all the laws that relate to handicapped rights, nor does this synopsis include all the requirements or identify penalties for non-compliance. The references are included so that the letter of the law can readily be researched; the interpretations are strictly those of the author.

As can be seen there are many statutes that guarantee the rights of disabled people in buildings, facilities, and outside areas. The Accessibility Standards provide a method for achieving this end.

### EDUCATION FOR CHILDREN AND ADULTS

The 14th Amendment to the **United States Constitution** calls for "equal protection of the laws" for all citizens. This means that handicapped children are entitled to an education like other children.

The **Constitution of Illinois** in Art. 10 §1 states: "A fundamental goal of the People of the State is the educational development of all persons to the limits of their capacities."

The **Education for All Handicapped Children Act** (20 U.S.C.A. §1401 et seq.) signed November 1975, is a National law which requires a free appropriate public education for all handicapped children in the United States. The program developed for the child must assure that, whenever appropriate, handicapped children will be educated with children who are not disabled. Special classes and separate schooling are provided only when the nature or severity of the handicap prevents achievement of a satisfactory education program.

**Chapter 122, Art. 14, The School Code of Illinois and the State Rules and Regulations to Govern the Administration and Operation of Special Education, August 1976** mandate Special Education Services for all handicapped children. The U.S. Office of Education (Bureau of the Education of the Handicapped) allows 12% of the school population to be counted as handicapped for funding purposes.

Many children who are considered disabled are not educationally handicapped, and do not require a special educational program. They should not be classified as having an educational handicap, if their disabilities do not interfere with their schooling or that of other children.

Among the programs are the following: **an Early Childhood Program, Special Classes/Programs** for those with specific disabilities, and a **Pre-vocational Program**.

Great emphasis is now being placed on mainstreaming of handicapped students into the regular program. Rules and regulations, Article 9.17, states that the child shall be placed in the educational program most appropriate to his needs and least restrictive in his interaction with non-handicapped children.

## EMPLOYMENT

Discrimination in employment against qualified handicapped individuals is prohibited by the **Vocational Rehabilitation Act of 1973** (29 U.S.C.A. §701 et seq.) The provisions of Section 793(a) (commonly referred to as Section 503) of the Act require that where contracts above \$2,500 are entered into by Federal departments or agencies they must contain an affirmative action provision which commits employers to hire and advance qualified handicapped individuals. Passive non-discrimination is no longer adequate.

Employers must make reasonable accommodation to the known physical or mental limitations of a handicapped applicant or employee, unless they can demonstrate that this would impose an undue hardship. Employers must make facilities accessible to the handicapped persons and acquire or modify equipment or devices.

The Act requires that no qualified handicapped person shall, because a recipient's (employer's) facilities are inaccessible to or unusable by the handicapped person, be denied the benefit of, be excluded from participation in, or otherwise be subjected to discrimination under any program or activity.

**The White Cane Law** (Ill. Rev. Stat., Ch. 23, Par. 3365) prohibits discrimination against qualified blind and handicapped persons by State agencies, public schools and all other employment supported by public funds.

**The Equal Opportunities for the Handicapped Act** (Ill. Rev. Stat., Ch. 38, Par. 65.21) prohibits discrimination against qualified physically and mentally handicapped persons in hiring, discharging, terms of employment and conditions of employment.

An amendment to the **Fair Employment Practices Act** (Ill. Rev. Stat., Ch. 48, Pars. 851, 853, 857) prohibits discrimination against qualified physically and mentally handicapped persons in hiring and testing

Students receiving special education services must go to school in the same buildings as non-handicapped students. Special classes and separate schooling is permitted only when the nature or severity of the child's handicap prohibits education in regular classes, Rules and Regulations. Article 3.04.

State law mandates the education of all handicapped children. All public school districts are required to provide for the education of any handicapped child within its district. If a school district decides that a child's educational needs cannot be met through a public school special education program, it must provide an alternate placement – either in a private school or in a State operated facility.

## TRANSPORTATION

The **Urban Mass Transportation Act** of 1970 (49 U.S.C.A. §1601 et seq.) declares that, as a national policy, elderly and handicapped persons have the same right as other persons to utilize public transportation facilities and services. Section 1612 of the law requires that special efforts be made in designing mass transportation services and facilities so that they are available to elderly and handicapped persons.

The **Highway Act** of 1973 (23 U.S.C.A. §101) Section 165b, requires assurance that all Federally funded projects designed to improve bus or other motor mass transportation under the Act shall be planned and designed so that mass transportation facilities and services can effectively be utilized by elderly and handicapped persons.

The **White Cane Law** (Ill. Rev. Stat., Ch. 23, Pars. 3361-3366) states that the blind, visually handicapped or otherwise physically handicapped people are entitled to full and equal accommodations and facilities of all common carriers.

## ARCHITECTURAL BARRIERS

The **Architectural Barriers Act of 1968** (42 U.S.C.A. §4151 et seq.) requires that any building constructed in whole or in part with Federal funds must be made accessible to and usable by the physically handicapped. This law applies to any building designed, constructed or altered by the General Services Administration, the Department of Housing and Urban Development and the Department of Defense.

The **Federal Aid Highway Act** of 1973 (23 U.S.C.A. §101 et seq.) requires access across State highway curbs. The Secretary of Transportation may not approve any State highway programs which do not provide for adequate and reasonable access for the safe and easy movement of the physically handicapped across curbs. This curb cut requirement applies to all curbs constructed or replaced at pedestrian crosswalks on or after July 1, 1976.

The **Facilities for the Handicapped Act** (Ill. Rev. Stat., Ch. 111, Par. 11, et seq.) provides facilities for the handicapped in newly constructed or remodeled public buildings. The Act contains, within its declaration of object, the essential concerns of safety and full enjoyment of handicapped people in public buildings.

The **Illinois Municipal Code**, (Ill. Rev. Stat., Ch. 24, Par. 11-80-11) mandates that all new curbs and all existing curbs undergoing reconstruction be ramped with a non-slip surface. This requirement applies to crosswalks in a block which is contiguous to a highway or is in an area in which 50% of the territory is zoned for business, commercial or industrial use.

## CIVIL RIGHTS

The **Rehabilitation Act of 1973** (29 U.S.C.A. §701 et seq. par. 794) commonly known as Section 504 states that no otherwise qualified handicapped individual in the United States shall, solely by reason of his handicap, be excluded from the participation in, be denied the benefits of, or be subjected to discrimination under any program or activity receiving Federal financial assistance.

The **Illinois Criminal Code** (Ill. Rev. Stat., Ch. 38, Par. 13-2) defines it as a Violation of Civil Rights if full equal use of public places is denied because of race, religion, color national ancestry, physical or mental handicap.

Chapter 38, Par. 13-1 defines a Public Place of Accommodation of Amusement to include such places as: inns, restaurants, hotels, taverns, barbershops, elevators, busses, department stores, bathrooms, theaters, skating rinks, public golf courses, railroads, airplanes and other places of public accommodations or amusement.

The **White Care Law** (Ill. Rev. Stat., Ch. 23, Par. 3361) defines the policy of the State of Illinois to encourage and enable the blind, visually handicapped, and otherwise physically disabled person to participate fully in the social and economic life of this State, and shall have equal right to full and free use of streets, highways, sidewalks, walkways, public buildings, public facilities and other public places including that as lodging places, places of public accommodations and places of entry to the general public.

## COMPLIANCE WITH ACCESSIBILITY STANDARDS

**Paragraph 792** (commonly known as Section 502) of the 1973 **Rehabilitation Act** (29 U.S.C.A. 701 et seq.) created the Architectural and Transportation Barriers Compliance Board which is responsible for insuring compliance with the **Architectural Barriers Act** of 1968 (42 U.S.C.A. 4151 et seq.)

The **Facilities for Handicapped Act** (Ill. Rev. Stat., Ch. 111, Par. 15) requires that the appropriate contracting authority which constructs or remodels a building or facility determine that it meets the Accessibility Standards. Contracting authorities are the State or any political subdivision, governmental entity or public authority.

No building permit or other official authorization for construction of a public building as defined in Section 1.1.3 of the Accessibility Standards is valid unless it recites that the plans and specifications meet these Standards.

**Paragraph 16.1 of the Facilities for Handicapped Act** require the Attorney General to investigate any complaint or reported violation of this Act, and where necessary to ensure compliance, the Attorney General may, at any time, bring action for mandamus, injunction or other appropriate relief.

## SELECTED BIBLIOGRAPHY

- AMERICAN SOCIETY OF LANDSCAPE ARCHITECTS FOUNDATION AND HUD.**  
**Barrier Free Site Design.**  
U.S. Government Printing Office Washington, D.C., 1976.
- AMERICAN TELEPHONE AND TELEGRAPH COMPANY.**  
**Universal Public Telephone Height for Handicapped and Able-bodied Users.**  
Research Section/Marketing Department, American Telephone and Telegraph Co., New York, 1975.
- ANSI A117.1**  
**Making Building Accessible and Usable by the Physically Handicapped.**  
American National Standards Institute, New York, 1971.
- ARCHITECTURAL AND TRANSPORTATION BARRIERS COMPLIANCE BOARD**  
**Resource Guide to Literature on Barrier-Free Environments—with selected annotations.**  
Architectural and Transportation Barriers Compliance Board, Washington, 1977.
- BIRREN, JAMES E. and SCHAIK, WARNER K.**  
**Handbook of the Psychology of Aging.**  
Van Nostrand Reinhold Company, New York, 1976.
- BRATTGARD, SVEN OLAF.**  
**Unpublished Research at the University of Goteberg,**  
Sweden, 1967-1974.
- COTLER, STEPHEN R. and DeGRAFF, ALFRED H.**  
**Architectural Accessibility for the Disabled of College Campuses.**  
State University Construction Fund, State University of New York, Albany, New York, 1976.
- DIFFRIENT, NIELS, TILLEY, ALVIN R. and BARDGJY, JOAN C.**  
**Humanscale 1/2/3.**  
MIT Press, Cambridge, Massachusetts, 1974.
- DIXON, CHARLES E.**  
**A study to Determine the Specifications of Wheelchair Ramps.**  
Ph.D. dissertation, University of Illinois, 1957.
- DREYFUSS, HENRY.**  
**The Measure of Man.**  
Whitney Library of Design, New York, 1967.
- FLOYD, W. F., GUTTMEN, L., NOBLE, W., PARKES, K. R. and WARD, J.**  
**A Study of the Space Requirements of Wheelchair Users.**  
Paraplegia, 4, pp 24-37, May 1966.

- FRUIN, JOHN J.**  
**Pedestrian Planning and Design.**  
Metropolitan Association of Urban Designers and Environmental Planners, New York, 1971.
- GELICK, MICHAEL S. and SILVER, MARSHALL L.**  
**Design for the Handicapped in Elevated Transportation Systems.**  
Research Report #74-5, University of Illinois, Chicago Circle, 1974.
- GOLDSMITH, SELWYN.**  
**Designing for the Disabled.**  
3rd Edition, RIBA Publication Ltd., London, England, 1976.
- GRANDJEAN, ETIENNE.**  
**Ergonomics of the Home.**  
Taylor and Francis, London and Halstead Press (a division of John Wiley Sons), New York, 1973.
- HERMES, BRUCE F., ELIAS, HELEN, and ROBBINS, DONALD O.**  
**Guidestrips for Visually Handicapped Pedestrians.**  
Metropolitan Association of Urban Designers and Environmental Planners, Inc. Third National Seminar on The Planning, Design and Implementation of Bicycle and Pedestrian Facilities, San Diego, California, 1974.
- KIDWELL, ANN MIDDLETON and GREER, PETER SWARTZ.**  
**Sites Perception and the Non-visual Experience.**  
Designing and manufacturing mobility maps. American Foundation for the Blind, New York, 1973.
- KLIMENT, STEPHEN A.**  
**Into the Mainstream.**  
A syllabus for a barrier-free environment. The American Institute of Architects, under a grant from DHEW, Rehabilitation Services Administration, Washington, D.C., 1975.
- LAURIE, GINI.**  
**Housing and Home Services for the Disabled.**  
Medical Department, Harper and Row, Publishers, Hagerstown, Maryland, 1977.
- LEONARD J.A.**  
Studies in blind mobility.  
**Applied Ergonomics,**  
p. 3746, March 1972.
- MACE, RONALD I.**  
**An Illustrated Handbook of the Handicapped Section of the North Carolina State Building Code.**  
North Carolina Building Code Council and the North Carolinas Department of Insurance, 1974.

**MACE, RONALD I.**

**Accessibility Modifications.**

Guidelines for modifications to existing buildings for accessibility to the handicapped North Carolina's Department of Insurance, Engineering and Building Codes Divisions, 1976.

**McCORMICK, ERNEST J.**

**Human Factors Engineering.**

McGraw-Hill, New York, 1970.

**McCULLOUGH, HELEN E. and FARNHAM, MARY B.**

**Kitchens for Women in Wheelchairs.**

College of Agriculture, Extension Service in Agriculture and Home Economics, Circular 841, University of Illinois, Urbana, Illinois, 1961.

**McCULLOUGH, HELEN E. and FARNHAM, MARY B.**

**Space and Design Requirements for Wheelchair Kitchens.**

College of Agriculture Extension Service, Bulletin No. 611, 160, University of Illinois, Urbana, Illinois, 1960.

**NICHOLS, P.J.R.**

**Door Handles for the Disabled.**

Nuffield Orthopedic Center, Oxford: Annals of Physical Medicine. Vol. 8, London, England, February 1966.

**OLSON, EDITH V., (Editor).**

**The Hazards of Immobility.**

The American Journal of Nursing, Vol. 67, #4, 1967.

**OWNSWORTH, A.**

**An Ergonomic Study of the Space Requirements of Wheelchair Users for Doorways and Corridors.**

Institute for Consumer Ergonomics, England, 1973.

**PASTALAN, LEON A., MAUTZ, ROBERT K., II, and MERRILL, JOHN.**

The simulation of age related sensory losses. A new approach to the study of environmental barriers. **Environmental Design Research**, W.F.E. Preisser (Ed) Dowden, Hutchinson and Ross, Shroudsburg, Pennsylvania, 1973.

**PRESIDENT'S COMMITTEE ON EMPLOYMENT OF THE HANDICAPPED.**

**One in Eleven: Handicapped Adults in America. A Survey Based on the 1970 U.S. Census Data**, Washington, D.C., 1975.

**RUGE, DANIEL (Editor)**

**Spinal Cord Injuries**

Clarke C. Thomas, Publisher, Springfield, Illinois 1969

**STATE OF ILLINOIS.**

**Standard Specifications for the Facilities for the Handicapped.**

Authorized and Enforceable under Ill. Rev. Statutes, Chapter III, Section 1, etc.

**STEIDL, ROSE E. and BRATTON, ESTHER C.**

**Work in the Home.**

John Wiley Sons, New York, 1968.

**STEINFELD, EDWARD, SCHROEDER, STEVEN, BISHOP, MARILYN,**

**FASTE, ROLF and AIELLO, JAMES.**

**Experimental Research in Accessibility.**

Syracuse University, School of Architecture, Research Office. Unpublished reports. Syracuse, New York, 1976.

**TEMPLER, JOHN A.**

**Stair Shape and Human Movement.**

Unpublished doctoral dissertation. Columbia University, New York, 1974.

**TEMPLER, JOHN A. and JONES, MICHAEL A.**

**Handicapped Problem Statements.**

Unpublished investigation into problems experienced by elderly and handicapped pedestrians as a result of research carried out by the Pedestrian Research Laboratory, Georgia Institute of Technology, funded by the U.S. Department of Transportation, contract number DOT-FH-11-8504.

**TURNER, EUGENE P. and MAPLE, ROBERT C.**

**Estimates of Disabled Persons in Illinois.**

State of Illinois, Department of Vocational Rehabilitation, Springfield, Illinois, 1974.

**U.S. SENATE, 92nd Congress, 1st Session.**

**A Barrier Free Environment for the Elderly and Handicapped.**

Hearings before the Special Committee on Aging, October 1971.

**U.S. SENATE, 94th Session.**

**The Effectiveness of the Architectural Barriers Act of 1968 (Public Law 90-480).**

Hearings before the Subcommittee on Investigations and Review of the Committee on Public Works and Transportation, October 1975

**WACHTER, PETER LORENC, JOHN and LAI, EDWARD.**

**Urban Wheelchair Use, A Human Factor Analysis.** Access Chicago, Rehabilitation Institute of Chicago, Chicago, 1977.

**WACHTER, PETER and CATLIN, JACK.**

**Open House, Preparing a Successful Home Environment for the Wheelchair User.** Access Chicago, Rehabilitation Institute of Chicago, Chicago, March 1977.

**WALTER, FELIX.**

**Four Architectural Movement Studies for the Wheelchair and**

**Ambulant Disabled.**

Disabled Living Foundation, London, 1971.

## INDEX

### A

- Access Aisle definition 1.1.3
- Access Covers 3.2.7
- Access Point, Site definition 1.1.3
- Accessibility definition 1.1.3
- Accessibility, Basic definition 1.1.3
- Accessibility, Full definition 1.1.3
- Adjustable Volume Control, Telephones 11.1.10
- Administrative Authority definition 1.1.3
- Agility, Chronic Restrictive Conditions Affecting 2.6
- Aid Visual definition 1.1.3
- Aid, Walking definition 1.1.3
- Air Conditioners 15.1.3
- Alcoves for Drinking Fountains 9.1.1
- Ambulatory definition 1.1.3
- Ambulatory, Semi- definition 1.1.3
- Apartment definition 1.1.3
- Apartment Building definition 1.1.3
  - Residential Structures 16.1
- Appliances for Public Use 15.1
- Laundry Equipment 15.1.2
- Air Conditioners 15.1.3
- Assembly Occupancy, see Public Buildings 1.1.3
- Audible Cue definition 1.1.3
- Cueing Aids 2.8.2
  - Elevator Cues 7.1.6, 7.1.7, 7.1.15
- Auditoria, Arenas, Assembly Halls and Stadia 16.7
- Number of Places for Persons in Wheelchairs Table 16.7.2
- Number of Seats for Persons with Crutches Table 16.7.6
- Number of Seats for Hearing Systems Table 16.7.7
- Requirements for Persons in Wheelchairs 16.7.4
- Auditory Impairment, Severe 2.7
- Automatic Doors
  - Protection from Swing of 4.1.16
  - Manually Operated Openers 4.1.17

### B

- Balusters 6.3.10
- Barriers, Locatable 3.8
  - Landscape Requirements in or Adjacent Walks 3.8.1

- Chains, Cables or Ropes 3.8.3
- Temporary Barriers at Excavations, etc. 3.8.4
- Temporary Walks at Construction Sites 3.8.5
- Basic Accessibility definition 1.1.3
- Bathrooms
- Health Facilities number required 16.4.2
  - Requirements Figure 16.4.2
- Hotels, Motels number required 16.2.3 Table 16.2.3
- Requirements 16.2.4 Figure 16.2.4
- Residential examples of minimum size Figure 16.1.5
- Structural Requirements for Grab Bars 16.1.6 Figure 16.1.5
- Bedrooms
- Health Facilities number required 16.4.2
  - Visual Emergency Warning Signals 16.4.3
- Hotels, Motels number required 16.2.3 Table 16.2.3
- Bending, Difficulty 2.10
- Blind to a Common Level definition 1.1.3
- Blind Location Cues, Tactile Warning Signals 12.3
  - At Top of Stairs 6.2.4
- Blind Location Cues 12.3.6
- Blind Warning Signals where required 12.3.1
- Comparison of Hardness of Walkway Materials 12.3.4
- Cueing Aids 2.8.2
  - Curb Ramp Requirements 3.3.3, 3.3.4
  - Elevator Control Panels 7.1.14
  - Elevator Hoistway Entrance Requirements 7.1.4
  - Emergency Exit Manual Door Openers 4.2.7, 12.2.3
  - Examples of Hazardous Locations Figure 3.2.9
  - Main Exit Floor Indication on Handrails 6.3.7
  - Surface Texture Patterns 12.2.3
  - Textured Strip 12.3.9
- Blindness, See Severe Visual Impairment 2.8
  - Cueing Aids 2.8.2
  - Long Cane Technique 2.8.1
- Blindness, Color 2.8.3
- Business Occupancy, See Public Building definition 1.1.3

### C

- Cables, Locatable 3.8.2
- Cafeteria Lines 16.8
  - Entrance Control Devices 16.8.6
  - Height and Reach Limitations 16.8.3 Figure 16.8.3
  - Microwave Oven Warnings 16.9.4 Figure 16.9.4
  - Reach Limitations 16.8.5
- Cane Technique, Long 2.8.1
  - Requirements for Objects to be in the Detectable Range of the Long Cane: Automatic Swing Doors 4.1.16



Blind Location Cues **12.3**  
 Circulation Below Stairs **6.2.10**  
 Elevator Lobbies **7.1.2**  
 Entrances in Glass Walls **4.1.18**  
 Interior Circulation Routes **5.1.6**  
 Locatable Barriers **3.8.3, 3.8.4**  
 Site Furniture **3.7.1**  
 Tactile Warning Signals **12.3 et seq.**  
 Walks and Sidewalks **3.2.9, 3.2.10**  
 Requirements for Objects Which Do Not Fall in the Detectable Range of the Long Cane:  
   Handrails, Guardrails **6.3.6**  
   Landscaping **3.13.16**  
   Ramps **6.1.11**  
   Stairs **6.2.9**  
   Supports **14.2.4**  
 Card Slots **14.1.1, 14.1.5, 14.1.6**  
 Chains, Locatable **3.8.2**  
 Chairs, Fixed Auditoria, Arenas, Assembly Halls **16.7.1, 16.7.6, 16.7.7**  
 Restaurants and Dining Halls **16.9.3**  
 Seating – Site Furniture **3.7.5**  
 Stadia **16.7.1, 16.7.6, 16.7.7**  
 Requirements for Objects to be in the Detectable Range of the Long Cane:  
 Children, Requirements for Students 12 Years Old and Under **16.3.1**  
 Ramps **6.1.5**  
 Stairs **6.2.6**  
 Chronic Impairment of Upper Extremities and Shoulders **2.4**  
 Chronic Restrictive Conditions Affecting Agility, Stamina and Reaction Time **2.6**  
 Circulation Route definition **1.1.3**  
 Exterior **3.1 et seq.**  
 Slope of **3.1.1**  
 Interior **5.1 et seq.**  
 Means of Egress **5.1.2**  
 Width of **5.1.4**  
 Closers, Door **4.1.14, 4.1.15**  
 Clubs, see Public Building definition **1.1.3**  
 Coin-operated Public and Semi-public Telephones **11.1 et seq.**  
 Coin Slots **14.1.5**  
 Color Blindness **2.8.3**  
 Communication and Identification **12**  
 Emergency Elevator Communication **7.1.17**  
 Emergency Warning Signals and Alarms **12.2 et seq.**  
 Fire Alarm Devices **12.2.5**  
 Microwave Oven Warning **12.2.4**  
 Signage **12.1 et seq.**  
 Transportation Terminals and Stations **16.5.1**  
 Comply With definition **1.1.3**  
 Conform to – see Comply With definition **1.1.3**  
 Confusion and/or disorientation **2.9**  
 Controls, Dispensers and Receptacles **3.9**  
 Force Required to Operate **14.1.3, 14.1.4**  
 Illumination **14.1.6**  
 Location **14.1 et seq.**  
 Cue definition **1.1.3**  
 Cue, Audible definition **1.1.3**  
 Emergency Warning Signals and Alarms **12.2 et seq.**  
 Elevators **7.1.6, 7.1.7, 7.1.15**  
 Cue, Redundant definition **1.1.3**  
 Controls **14.1.3**  
 Communication **16.5.1, 16.5.2**  
 Cueing Aid **2.8.2**  
 Curb Ramps **3.3.3**  
 Door Handles **4.2.4, 4.2.7, 12.2.3, 17.1.6**  
 Door Signs **Figure 4.3.1, 8.1.2, 12.1.2**  
 Elevators **7.1.4, 7.1.5, 7.1.6, 7.1.7, 7.1.14, 7.1.15**  
 Entrances in Glass Walls **4.1.18**  
 Emergency Warning Signals and Alarms **12.2.1, 12.2.2**  
 Emergency Warning Systems **16.2.5, 16.4.3**  
 Interior Circulation **5.1.6**  
 Locatable Barriers **3.8 et seq.**  
 Signage **12.1 et seq.**  
 Stairs – Warning **6.2.4**  
 Stairs – Main Exit Floor Indication **6.3.7**  
 Tactile Warning Signals and Blind Location Cues **12.3 et seq.**  
 Telephones **11.1.9, 11.1.11**  
 Cue, Tactile definition **1.1.3**  
 Circulation **3.2.9, 3.2.10, 3.7.1, 5.1.6, 7.1.2**  
 Curb Ramps **3.3.3**  
 Door Handles **4.2.4, 4.2.7, 12.2.3, 17.1.6**  
 Door Signs **Figure 4.3.1, 8.1.2, 12.1.2**  
 Elevators **7.1.4, 7.1.5, 7.1.14**  
 Entrances in Glass Walls **4.1.18**  
 Locatable Barriers **3.8 et seq.**  
 Signage **12.1, 12.1.2, 12.1.6**  
 Stairs – Warnings **6.2.4**  
 Stairs – Main Exit Floor Indication **6.3.7**  
 Tactile Warnings Signals and Blind Location Cues **12.3 et seq.**  
 Cueing Aid definition see Cue **1.1.3, 2.8.2**  
 Curb definition **1.1.3**  
 Location Cue **12.3.1**  
 Curb Ramp definition **1.1.3**  
 Curb Ramp Requirements **3.3 et seq.**  
 Crosswalk, Pedestrian Crossing  
 Street Crossing definition **1.1.3, 3.4 et seq.**

## D

- Detectable definition 1.1.3
- Difficulty Kneeling, Bending, Turning, Sitting, Kneeling and Rising 2.10
- Dimensions of Wheelchairs 2.3.2
- Dining Halls, Restaurants 16.9
  - Tables 16.9.2
  - Fixed Chairs 16.9.3
  - Microwave Oven Warning 16.9.4
- Disabling Condition definition 1.1.3
- Disorientation, Obvious Confusion and 2.9
- Dispenser Controls 8.1.15
- Dispenser Location 14.1, 14.1.2
- Force Required to Operate 14.1.3, 14.1.4
- Illumination 14.1.6
- Dispensers Toilet Rooms 8.1.14
- Doors and Doorways, Entrances 4.1 et seq.
  - Automatic 4.1.16, 4.1.17
  - Bottom Rail of 4.1.12
  - Closers 4.1.14, 4.1.15
  - Doors in Series 4.1.5
  - Door Mats and Gratings 4.1.8, 4.1.9
  - Floor surfaces at Entrances 4.1.1
  - Gates, Pedestrian 3.6 et seq.
  - Opening Force 4.1.13
  - Revolving Doors 4.1.2
  - Sliding Doors 4.1.11
  - Vestibules 4.1.5
  - Width 4.1.3
- Door Handles 4.2 et seq. 12.3, 17.1.6
- Door Openers, Emergency 4.2.7, 12.2.3, 17.1.6
- Drinking Fountains 9.1 et seq.
  - External Drinking Fountains and Water Coolers 9.1.7
  - Hand Controls 9.1.4
  - Height of Orifice 9.1.2
  - Location 5.1.3
  - Location of Orifice and Direction of Water Flow 9.1.3
  - Recessed 9.1.1
  - Wall Mounted 9.1.5
  - Dwelling Unit definition 1.1.3

## E

- Educational Buildings, Libraries and Museums 16.3 et seq.
- Facilities for Students 12 Yrs. and Under 16.3.1
- Laboratories 16.3.5
- Lockers 16.3.3

- Remodeling 16.3.7
- Showers 16.3.5
- Educational Occupancy see Public Building definition 1.1.3
- Egress, Means of definition 1.1.3
- Elderly definition 1.1.3
- Elderly Needs of 2.6, 2.7, 2.8
- Electrical Fixtures and Controls 14.3
  - Location 14.3.1, 14.3.4
  - Operation 14.3.2
  - Switches in Hotels, Motels 14.3.3
- Elevators 7.1 et seq.
  - Automatic Door Operation 7.1.11
  - Call Buttons 7.1.5
  - Car Position Indicators 7.1.15
  - Controls 7.1.14
  - Door Opening and Closing Requirements 7.1.7, 7.1.8
  - Door Widths 7.1.10 Table 7.1.12
  - Emergency Communication 7.1.17
  - Floor Designation 7.1.4
  - Floor Surface Requirements 7.1.3, 7.1.19
  - Handrail Requirements 7.1.16
  - Location 7.1.1
  - Minimum Illumination 7.1.21
  - Running Clearance 7.1.20
  - Self Leveling Feature 7.1.9
  - Size of Cars 7.1.12, Table 7.1.12, 7.1.13
  - Stretcher Requirement 7.1.13
  - Visual and Audible Signals 7.1.6
- Elevator, Zoned definition 1.2.3
  - Call Buttons at Main Entrance and Transfer Floors 7.1.5
  - Emergency Devices – Fire Alarm Devices 12.2.5
  - Emergency Exits 5.1.2
  - Emergency Warning Signals and Alarms 12.2 et seq.
  - Elevator Emergency Communication 7.1.17
  - Emergency Exits, Manual Door Openers 4.2.7, 12.2.3, 17.1.6
  - Fire Alarm Devices 12.2.5, 14.1.2
  - Visual and Audible Emergency Warning Systems 12.2.1, 12.2.2, 6.2.5
- Emergency Warning, Visual definition 1.1.3
- Health Facilities 16.4.3
  - Hotels, Motels 16.2.5
  - Enforcement Violations 1.1.5
- Entrances, Doors and Doorways 4.1 et seq.
  - Automatic Doors 4.1.16, 4.1.17
  - Bottom Rail of Doors 4.1.12
  - Door Closers 4.1.14, 4.1.15
  - Doors in Series 4.1.5
  - Door Mats and Gratings 4.1.8, 4.1.9
  - Emergency Exits 4.2.7, 12.2.3, 17.1.6

Glass at Entrances **4.1.18**  
Opening Force of Doors **4.1.13**  
Revolving Doors, Alternatives **4.1.2**  
Sliding Doors **4.1.11**  
Surface at Entrances **4.1.1**  
Thresholds **4.1.10**  
Width of Doorways, Clear **4.1.3**  
Entrances, Major definition **1.1.3**  
Entrances, Service definition **1.1.3**  
Evacuation Plan definition **1.1.3**  
Exit definition **1.1.3**  
Exits, Emergency **5.1.2**  
Exterior Circulation Routes **3.1 et seq.**  
Moving Walkways **3.1.4**  
Parking **3.1.3**  
Slope of **3.1.1**

## F

Faucets **8.1.10, 8.1.11**  
Fire Alarm Devices **12.2.5, 14.1.2**  
Fire Alarm Location **5.1.3**  
Fire Resistive Rating definition **1.1.3**  
Floor Surfaces, Ground and **13.1 et seq.**  
Carpet Requirements **13.1.3, 13.1.4, 13.1.5**  
Curb Ramps **3.3.3, 3.3.5, 12.3.7**  
Elevators **7.1.3, 7.1.19**  
Entrances **14.1.1**  
Requirements for Brick, etc. **13.1.1, 13.1.2**  
Slip Resistant Finishes **13.1.6**  
Friction Coefficient of Floor Surface **13.1.6**  
Full Accessibility definition **1.1.3**  
Funeral Homes, see Public Building definition **1.1.3**  
Furniture

Library Stacks **16.3.6**  
Lockers **16.3.3**  
Restaurants, Dining Halls **16.9.2, 16.9.3**  
Seating, Interior **16.7.1, 16.7.2, 16.7.6, 16.7.7, 16.9.3**  
Tables **16.9.2**  
Furniture, Site, Street definition **1.1.3**  
Location of **3.7.1, 3.7.2**  
Rest Areas **3.7.4**  
Seating **3.7.5**  
Tables **3.7.6**

## G

Garages, Parking see Public Building definition **1.1.3**  
Parking Structures **3.5.6, 3.5.7**  
Gas Stations see Public Building definition **1.1.3**  
Gates, Pedestrian **3.6**  
Glass Walls at Entrances **4.1.18**  
Grab Bars, Supports **14.2**  
At Water Closets **8.1.7**  
In Bathrooms **16.1.6, 16.2.4**  
Reinforcement for **16.1.6**  
Requirements for Children under 12 Yrs. old **16.3.1**  
Shower Requirements **10.1.1**  
Gratings **3.2.7**  
Grocery Stores **16.10 et seq.**  
Check-out Point, Access Aisles **16.10.1**  
Barriers to Prevent Removal of Shopping Carts **16.10.2**  
Ground and Floor Surfaces **13.1 et seq.**  
Blind Locations Cues **12.3.6**  
Carpet Requirements **13.1.3, 13.1.4, 13.1.5**  
Curb Ramps **3.3.3, 3.3.5, 12.3.7**  
Elevators **7.1.3, 7.1.19**  
Entrances **14.1.1**  
Requirements for Brick, etc. **13.1.1, 13.1.2**  
Slip Resistant Finishes **13.1.6**  
Stairs **6.2.4, 6.2.7**  
Tactile Warning Signals and Blind Location Cues **12.3 et seq.**  
Texture Strip **12.3.9**  
Walking Surface **12.3.1, 12.3.2, 12.3.3, 12.3.4, 12.3.5, 12.3.8**  
Guardrails, Handrails **6.3 et seq.**  
Balusters, Intermediate Rails, Ornamental Closures, Panels **6.3.10**  
Height of **6.3.9**  
Walks **3.8.2**  
Guardrails, Supports **14.2 et seq.**

## H

Hand Controls  
Appliances **15.1 et seq.**  
Drinking Fountains **9.1.4**  
Faucets **8.1.10, 8.1.11, 14.4.3**  
Location **14.1 et al 15.1.3**  
Switches **14.3.2, 14.3.3, 14.3.4**  
Handicapped Person definition **1.1.3**  
Handrails, Guardrails **6.3 et seq.**  
Balusters, Intermediate Rails, Ornamental Closures, Panels **6.3.10**  
Clearance Between Handrail and Wall **6.3.5**

Height on Ramps **6.1.5**  
 Height on Stairs **6.2.6**  
 Loan Requirement **6.3.2**  
 Main Exit Floor Cue **6.3.7**  
 Maximum Width Between Handrails **6.3.8**  
 Handrails, Supports **14.2 et seq.**  
 Hard Surface definition **1.1.3**  
 Hardware, Door Handles **4.2 et al** **8.1.7, 12.2.3, 16.1.7, 17.1.6**  
 Health Facilities **16.4 et seq.**  
   Bedrooms and Bathrooms **16.4.2**  
   Visual Emergency Warning Signals **16.4.3**  
 Hearing Systems, Number of Seats in Auditoria, etc. **16.7.7, Table 16.7.7**  
 Historic Preservation, Historic Reconstruction definition **1.1.3**  
 Requirements **18 et seq.**  
 Hot Air, Hand Drying Equipment **8.1.16**  
 Hotels, Motels **16.2 et seq.**  
   Number of Fully Accessible Bedrooms with  
   Bathrooms **16.2.3 Table 16.2.3, 16.2.4**  
   Public Spaces **16.2.1**  
   Visual Emergency Warning Systems **16.2.5**  
 Human Data **2.1 et seq.**  
   Chronic Impairment of Upper Limbs and Shoulders **2.4**  
   Chronic Restrictive Conditions Affecting Agility,  
   Stamina and Reaction Time **2.6**  
   Difficulty Bending, Turning, Sitting, Kneeling and Rising **2.10**  
   Extremes of Size and/or Maturity **2.5**  
   Incontinence **2.11**  
   Obvious Confusion and/or Disorientation **2.9**  
   Severe Auditory Impairment **2.7**  
   Severe Visual Impairment **2.8**  
   Walking Disabilities **2.2**  
   Wheelchair Users **2.3**

## I

Identification, Communication **12 et seq.**  
 Emergency Warning Signals and Alarms **12.2**  
 Fire Alarm Devices **12.2.5**  
 Microwave Warning Signal **12.2.4**  
 Signage **12.1**  
 Impairment, Severe Auditory **2.7**  
 Impairment, Severe Visual **2.8**  
 In-car Lanterns definition **1.1.3**  
 Requirements **7.1.6, 7.1.7**  
 Incontinence definition **1.1.3**  
 Human Data **2.11**  
 Incoordination definition **1.1.3**  
   Slots, Coin, Ticket or Card **14.1.5**

Elevators, Handrails **7.1.16**  
 Industrial Occupancy see Public Building definition **1.1.3**  
 Interior Circulation - Residential **16.1.3**  
 Interior Circulation Routes **5.1 et seq.**  
   Emergency Egress **5.1.1**  
   Vertical Space Requirement **5.1.6**  
   Width of **5.1.4**  
 Interior Office Landscaping definition **1.1.3**  
 International Symbol of Accessibility **12.1.7**  
 Island definition **1.1.3**  
 Requirements **3.4.2**  
 Width of **3.4.3**

## K

Kitchens, Residential **16.1.4**  
 Kneeling, Difficulty **2.10**

## L

Landscaping **3.13 et seq.**  
   Ancillary Requirements **3.8.1, 3.8.3**  
   Criteria for Planting Adjacent Walks **3.13.1**  
 Laundry Equipment **15.1.2**  
   Laundry Rooms in Public Apartment Buildings **15.1.1**  
 Lavatories **8.1.9**  
 Libraries **16.3**  
   Aisles and Stack Requirements **16.3.6**  
 Lip definition **1.1.3**  
 Listening System definition **1.1.3**  
   Requirements in Auditoria, etc. **16.7.7 Table 16.7.7**  
 Locatable Barriers **3.8 et seq.**  
   Landscape Requirements **3.8.1, 3.8.3**  
   Temporary Barriers **3.8.4, 3.8.5**  
 Long Cane Technique **2.8.1**  
   Requirements for Objects to be in the Detectable Range of the Long Cane  
   Automatic Swing Doors **4.1.16**  
 Blind Location Cues **12.3**  
 Circulation Below Stairs **6.2.10**  
 Elevator Lobbies **7.1.2**  
 Entrances in Glass Walls **4.1.18**  
 Interior Circulation Routes **5.1.6**  
 Locatable Barriers **3.8.3, 3.8.4**  
 Site Furniture **3.7.1**  
 Tactile Warning Signals **12.3 et seq.**  
   Walks and Sidewalks **3.2.9, 3.2.10**

Requirements for Objects Which do not Fall in the Detectable Range of the Long Cane  
 Handrails, Guardrails **6.3.6**  
 Landscaping **3.13.16**  
 Ramps **6.1.11**  
 Stairs **6.2.9**  
 Supports **14.2.4**

## M

Major Entrance definition **1.1.3**  
 Requirements **4.1 et seq.**  
 Manhole Covers **3.2.7**  
 Manual Door Openers definition **1.1.3**  
 Requirements **4.2 et seq.**  
 Openers into Firestairs, Fire Corridors **4.2.7, 12.2.3, 17.1.6**  
 Openers into Hazardous Areas **4.2.6, 17.1.6**  
 Maneuvering Space for Wheelchairs **2.3.2**  
 At Drinking Fountains **9.1.1**  
 At Receptacles and Dispensers **14.1.1, 14.1.2**  
 At Side of Doors **4.1.1**  
 At Telephones **11.1.1**  
 Doors in Series **4.1.5**  
 In Elevators **7.1.12**  
 In Toilet Stalls **8.1.7**  
 On Ramps **6.1.8, 6.1.9**  
 Service Counters **16.8 et seq.**  
 Vestibules **4.1.5**  
 Maturity, Extremes of **2.5**  
 Means of Egress definition **1.1.3**  
 Requirements **5.1, 5.1.2**  
 Meditation, Places of see Public Building definition **1.1.3**  
 Microwave Oven Warnings **12.2.4, 16.9.4**  
 Mirrors **8.1.13**  
 Motels, Hotels **16.2 et seq.**  
 Number of Fully Accessible Bedrooms with  
 Bathrooms **16.2.3** **Table 16.2.3, 16.2.4**  
 Public Space Requirements **16.2.2**  
 Visual Emergency Warning System **16.2.5**  
 Moving Walkways **3.1.4**  
 Museums **16.3**  
 Displays **16.3.8**  
 Laboratories **16.3.5**

## N

Non-detectable Area definition **1.1.3**  
 Locatable Barriers **3.8 et seq.**  
 Long Cane Technique **2.8.1**  
 Requirements for Projections into Circulation **3.2.10, 3.7.1, 5.1.6, 7.1.2, 11.1.3**  
 Nosing, Stair **6.2.3**

## O

Obvious Confusion and/or Disorientation **2.9**  
 Occupancy definition **1.1.3**  
 Change of Occupancy Requirements **17.1.1**  
 Opening Force for Doors **4.1.13**  
 Operable Part definition **1.1.3**  
 Orthotic definition **1.1.3**  
 In Walking disabilities **2.2**  
 Seating Spaces in Auditoria, etc. **16.7.6**  
 Outdoor Areas see Public Building definition **1.1.3**  
 Requirements Landscaping **3.13 et al**  
 Recreation **16.6 et al**  
 Overpasses, Pedestrian **3.4.4**

## P

Parking **3.5 et seq.**  
 Curbs Around Parking Spaces **3.58**  
 Historic Preservation and Historic Reconstruction **Table 18.1.1e**  
 Location of **3.1.3, 3.5.1**  
 Marking of Parking Spaces for Disabled **3.5.10**  
 Multi-Story Parking Requirements **3.5.7**  
 Number of Parking Spaces Required **3.5.5** **Table 3.5.5**  
 Passenger Loading zones **3.5.3**  
 Pedestrian Walks Through Parking Lots **3.5.10, 12.3.9**  
 Remodeling **Table 17.1.2e, Table 17.1.3e**  
 Waiver Requirements **3.5.11**  
 Width of Parking Spaces **3.5.4**  
 Parking Garages see Public Building definition **1.1.3**  
 Passenger Loading Zones definition **1.1.3**  
 Requirements **3.5.3**  
 Passing, Space Requirements for Pedestrians including  
 People in Wheelchairs **2.3.4**  
 Path of Travel see Circulation Route definition **1.1.3**  
 Exterior Circulation Routes **3.1 et seq.**  
 Historic Preservation and Historic Reconstruction **18.1.1a, 18.1.1d**  
 Interior Circulation Routes **5.1 et seq.**  
 Remodeling **Table 17.1.2a, Table 17.1.2c, Table 17.1.2e, Table 17.1.3a,**  
**Table 17.1.3c, Table 17.1.4a**

- Pay Telephones definition 1.1.3
  - Requirements 11.1 et seq.
  - Adjustable Volume Control 11.1.10
  - Aid for Visually Impaired 11.1.9
  - Cord to Handset 11.1.8
  - Entrance to Telephone Enclosures 11.1.4
  - Free Standing Telephones 11.1.2
  - Highest Operable Part 11.1.1
  - Illumination 11.1.12
  - Location 5.1.3, 11.1.1, 11.1.5
  - Push Button Controls 11.1.7
  - Requirements for Hearing Aids 11.1.11
  - Surfaces at Pay Telephones 11.1.3, 11.1.5
  - Telephone Books (Directories) 11.1.6
  - Pedestrian Crossings see Crosswalk definition 1.1.3
  - Curb Ramps 3.3.1, 3.3.4
  - Street Crossings 3.4 et seq.
  - Textured Strip 12.3.9c
  - Pedestrian Gates and Turnstiles 3.6 et seq.
  - Perceivable definition 1.1.3
  - Long Cane Technique 2.8.1
  - Cueing Aids 2.8.2
  - Curb Ramps 12.3.7
  - Redundant Cue definition 1.1.3
  - Street Crossings 3.4.2
  - Tactile Warning Signals 12.3.4 Table 12.3.4, 12.3.7
  - Textured Strip 12.3.9
  - Plans to Meet Accessibility Standards 1.1.4
  - Plumbing Fixtures 14.4 et seq.
  - Drinking Fountains 9.1 et seq.
  - Educational Buildings 16.3.1
  - Faucet Designs 8.1.10, 8.1.11, 14.4.3
  - Health Facility Bathrooms 16.4.2
  - Historic Preservation and Historic Reconstruction 18.1.1c
  - Hotel, Motel Bathrooms 16.2.3, 16.2.4
  - Lavatories 8.1.9, 14.4.2
  - Number of Toilet Fixtures 8.1.6
  - Number of Toilet Facilities for the Disabled 8.1
  - Remodeling Table 17.1.2d Table 17.1.3d Table 17.1.4c
  - Showers 10.1 et seq. 16.3.4
  - Specific Requirements at Various Locations 14.4.4
  - Wall-mounted Urinals 8.1.12
  - Water Closets 8.1.7
  - Water Temperature 8.1.11, 14.4.1
  - Prevailing Equivalent Sound Level definition 1.1.3
  - Emergency Warning Signals and Alarms 12.2.1
  - Prosthesis definition 1.1.3
  - Chronic Impairment of Upper Extremities and Shoulders 2.4
  - Seating Requirements in Auditoria, etc. 16.7.6
  - Walking Disabilities 2.2
  - Public Buildings definition and examples 1.1.3
  - Public Spaces definition 1.1.3
  - Public Telephones and Semi-public Telephones 11.1 et seq.
  - see Pay Telephones for Specific Requirements
  - Public Toilet Rooms 8.1
  - Dispensers and Receptacles 8.1.14, 8.1.15, 14.1.2
  - Door Width 8.1.3
  - Faucets 8.1.10, 8.1.11, 14.4.3
  - Historic Preservation and Historic Reconstruction 18.1.1c
  - Hot Air, Hand Drying Equipment 8.1.16
  - Lavatories 8.1.9, 14.4.2
  - Location 5.1.3, 8.1.1
  - Mirrors 8.1.13
  - Modesty Screens/Corridors 8.1.4
  - Symbol/Name Indication 2.9, 8.1.2
  - Tissue Dispensers 8.1.8
  - Urinals 8.1.12
- R**
- Ramps 6.1 et seq.
  - Allowable Slopes 6.1.1 Table 6.1.1
  - Carpet on Ramps 13.1.3
  - Edges 6.1.6
  - Handrails 6.1.5
  - Minimum Width 6.1.7
  - Platforms – Intermediate 6.1.8
  - Platforms at Top and Bottom 6.1.8
  - Ramps Along Accessible Paths of Travel and Fire Exits 6.1.2
  - Surface 6.1.10
  - Wcphole Requirements 6.1.4
  - Ramps, Curb definition 1.1.3
  - Requirements 3.3 et seq. 3.5.8, 12.3.7
  - Reaction Time, Chronic Restrictive Condition Affecting 2.6
  - Receptacles 14.1 et seq.
  - Location 14.1.2
  - Operation 14.1.3
  - Toilet Room Requirements 8.1.14
  - Recreation Facilities 16.6 et seq.
  - See Public Building definition – Assembly Occupancy and Outdoor Areas 1.1.3
  - Redundant Cue definition 1.1.3
  - Controls 14.1.3
  - Communication 16.5.1, 16.5.2
  - Cueing Aid 2.8.2
  - Curb Ramps 3.3.3

Door Handles **4.2.4, 4.2.7, 12.2.3, 17.1.6**  
 Door Signs **Figure 4.3.1, 8.1.2, 12.1.2**  
 Elevators **7.1.4, 7.1.5, 7.1.6, 7.1.7, 7.1.14, 7.1.15**  
 Entrances in Glass Walls **4.1.18**  
 Emergency Warning Signals and Alarms **12.2.1, 12.2.2**  
 Emergency Warning Systems **16.2.5, 16.4.3**  
 Interior Circulation **5.1.6**  
 Locatable Barriers **3.8 et seq.**  
 Signage **12.1 et seq.**  
 Stairs—Warning **6.2.4**  
 Stairs—Main Exit Floor Indication **6.3.7**  
 Tactile Warning Signals and Blind Location Cues **12.3 et seq.**  
 Telephones **11.1.9, 11.1.11**  
 Refuge definition **1.1.3**  
 Requirements **5.1, 5.1.2**  
 Regular Business Hours definition **1.1.3**  
 Accessible Entrances **4.1.2**  
 Remodeling definition **1.1.3**  
 Requirements **17.1 et seq.**  
 Residence, Single Family definition **1.1.3, 16.1**  
 Residence, Two Family definition **1.1.3, 16.1**  
 Residential Structures **16.1 et seq.**  
 Areas Open to Public **16.1.1**  
 Bathrooms **16.1.5, 16.1.6**  
 Doors **16.1.2**  
 Hallway and Corridor Widths **16.1.3**  
 Kitchen Requirements **16.1.4**  
 Rest Areas **3.7.4**  
 Restaurants, Dining Halls **16.9 et seq.**  
 Fixed Chairs **16.9.3**  
 Microwave Oven Warnings **12.2.4, 16.9.4**  
 Service Counters—Cafeteria Lines **16.8.3, 16.8.4, 16.8.5, 16.8.6**  
 Tables **16.9.2**  
 Waivers **16.9.5**  
 Revisions to Accessibility Standards **1.1.6**  
 Revolving Doors—Alternative Requirements **4.1.2**  
 Rising, Difficulty in **2.10**  
 Seats **3.7.5**  
 Supports **14.2 et seq.**  
 Ropes, Locatable **3.8.2**

**S**

Seating **3.7.5**  
 Space Alongside for Wheelchairs **3.7.4**  
 Seating Requirements for People in Wheelchairs in Auditoria, Arenas, Assembly Halls and Stadia **16.7.1, 16.7.2 Table 16.7.2, 16.7.3, 16.7.4, 16.7.5**

Seating Requirements for People with Orthotics and Prosthesis in Auditoria, etc. **16.7.6 Table 16.7.6**  
 Seating Requirements for People with Hearing Impairment in Auditoria, etc. **16.7.7 Table 16.7.7**  
 Semi-ambulatory definition **1.1.3**  
 Service Counters **16.8 et seq.**  
 Cafeteria Lines **16.8.3, 16.8.5, 16.8.6**  
 Space for Writing **16.8.2**  
 Width of Circulation Space **16.8.4**  
 Service Entrance definition **1.1.3**  
 Severability Clause **1.1.7**  
 Severe Auditory Impairment **2.7**  
 Severe Visual Impairment **2.8**  
 Shopping Cart Barriers **3.7.8, 16.10.2**  
 Shopping Centers, Grocery Stores **16.10**  
 Check-out Points, Aisles **16.10.1**  
 Barriers to Prevent the Removal of Shopping Carts **16.10.2**  
 Shoulder, Impairment of **2.4**  
 Shower Rooms **10.1 et seq.**  
 Educational Facilities **16.3.3**  
 Gang Showers **10.1.2**  
 Size **10.1.1**  
 Soap Tray **10.1.6**  
 Water Controls **10.1.3**  
 Sidewalks definition **1.1.3**  
 Requirements **3.2 et seq.**  
 Exterior Circulation Routes **3.1 et seq.**  
 Minimum Width **3.2.1**  
 Slope of **3.2.4, 3.2.5, 3.2.6**  
 Signage **12.12.1 et seq.**  
 Character Requirements **12.1.3**  
 Color Contrast **12.1.4**  
 Directional Signs **12.1.1**  
 Glare Free Surface **12.1.5**  
 International Symbol of Accessibility **12.1.7**  
 Microwave Oven Warning **12.2.4, 16.9.4**  
 Room Identification **12.1.2**  
 Single Family Residence definition **1.1.3**  
 Site definition **1.1.3**  
 Site Access Point definition **1.1.3**  
 Site Furniture definition **1.1.3**  
 Requirements **3.7 et seq.**  
 Drinking Fountains **9.1.7**  
 Location of **3.7.1, 3.7.2**  
 Rest Areas **3.7.4**  
 Seating **3.7.5**  
 Shopping Cart Barriers **3.7.8, 16.10.2**  
 Tables **3.7.6**  
 Telephones, Exterior Pay **11.1.1, 11.1.2, 11.1.3, 11.1.4, 11.1.5**

Sitting, Difficulty **2.10**  
 Size, Extremes of **2.5**  
 Sleeping Occupancy see Public Building definition **1.1.3**  
 Sliding Doors **4.1.11**  
 Slip Resistant Floor Finishes  
   Curb Ramps **3.3.5**  
   Elevator Car Floors **7.1.19**  
   Ramps **6.1.10**  
   Shower Stalls **10.1.3**  
   Stairs **6.2.5**  
   Toilet Room Floors **8.1.5**  
   Testing Method Friction Coefficient **13.1.6**  
   Sound Level, Prevailing Equivalent definition **1.1.3**  
   Spasticity definition **1.1.3**  
   Specifications to Meet Standards **1.1.4**  
   Stairs **6.2 et seq.**  
   Carpet on Stairs **13.1.3, 13.1.4**  
   Circulation Space Beneath a Stair **6.2.10**  
   Handrails **6.2.6, 6.3 et seq.**  
   Nosings **6.2.3**  
   Stair Proportions **6.2.1 Figure 6.2.1**  
   Tactile Warning Cue **6.2.4, 12.3.4**  
 Stamina, Chronic Restrictive Conditions Affecting **2.6**  
 Street Furniture, see Site Furniture definition **1.1.3**  
 Requirements **3.7 et seq.**  
 See Site Furniture  
 Students under 12 Yrs. Old - Criteria for **16.3.1**  
 Suitable Facilities definition **1.1.3**  
 Handicapped Person definition **1.1.3**  
 Support definition **1.1.3**  
 Requirements **14.2 et seq.**  
 Design Load **14.2.1**  
 Size **14.2.2**  
 Space Between Support and Wall **14.2.3**

**T**  
 Tables **3.7.6**  
 Dining Halls, Restaurants **16.9.2**  
 Tactile Cue definition **1.1.3**  
 Circulation **3.29, 3.2.10, 3.7.1, 5.1.6, 7.1.2**  
 Comparison of Hardness of Walkway Materials  
   Perceivable to the Blind **12.3.4**  
 Curb Ramps **3.3.3**  
 Door Handles **4.2.4, 4.2.7, 12.2.3, 17.1.6**  
 Door Signs **Figure 4.3.1, 8.1.2, 12.1.2**  
 Elevators **7.1.4, 7.1.5, 7.1.14**  
 Entrances in Glass Walls **4.1.18**  
 Locatable Barriers **3.8 et seq.**  
 Signage **12.1, 12.1.2, 12.1.6**  
 Surface Texture Patterns **12.3.2**  
 Stair Warnings **6.2.4**  
 Stairs - Main Exit Floor Indication **6.3.7**  
 Tactile Warning Signals and Blind Location Cues **12.3 et seq.**  
 Telephone--in Elevators **7.1.17**  
 Telephone, Pay definition **1.1.3**  
 Requirements **11.1 et seq.**  
 Adjustable Volume Control **11.1.10**  
 Calling Number Identification **11.1.9**  
 Entrance to **11.1.4**  
 Length of Handset Cord **11.1.8**  
 Location of **5.1.3, 11.1.2, 11.1.3, 11.1.5**  
 Minimum Illumination **11.1.12**  
 Provisions for Those with Hearing Aids **11.1.11**  
 Temperature, Water at Lavatories **8.1.11**  
 Insulation on Hot Water Pipes **14.4.1**  
 Showers **10.1.5**  
 Temporary Walks **3.8.5**  
 Textured Strip - Blind Location Cue **12.3.9**  
 Threshold **4.1.10**  
 Ticket Slots **14.1.5**  
 Toilet Rooms, Public **8.1 et seq.**  
 Dispensers and Receptacles **8.1.14, 8.1.15, 14.1.2**  
 Door Width **8.1.3**  
 Faucets **8.1.10, 8.1.11, 14.4.3**  
 Historic Preservation and Historic Reconstruction **18.1.1c**  
 Lavatories **8.1.8, 14.4.2**  
 Location **5.1.3, 8.1.1**  
 Hot Air, Hand Drying Equipment **8.1.16**  
 Mirrors **8.1.13**  
 Modesty Screens/Corridors **8.1.4**  
 Remodeling **Table 17.1.2d, Table 17.1.3d, Table 17.1.4c**  
 Symbol/Name Indication **2.9, 8.1.2**  
 Tissue Dispensers **8.1.8**  
 Urinals **8.1.2**  
 Water Temperature **8.1.11, 14.4.1**  
 Transportation Facilities see Public Building definition **1.1.3**  
 Terminals and Stations **16.5**  
 Information Source **16.5.1, 16.5.2**  
 Turning, Difficulty **2.10**  
 Turnstiles, Pedestrian **3.6**  
 Two-Family Residence definition **1.1.3**  
 Waiver **16.1**



## U

Underpasses, Pedestrian **3.4.4**  
Upper Extremities, Impairment of **2.4**  
Appliance Controls **15.1.1**  
Dispenser Controls **8.1.15**  
Door Openers **4.2, 4.2.1, 4.2.3**  
Drinking Fountain Operation **9.1.4**  
Electrical Switches **14.3.2**  
Elevator Buttons **7.1.14** **Figure 7.1.14**  
Faucets **8.1.10, 14.4.3**  
Fire Alarm Devices **12.2.5**  
Force Required for Operation of Controls **14.1.3**  
Force Required to Open Doors **4.1.13**  
Hand Operation of Controls **14.1.4**  
Handrails and Guardrails, Rail Design **6.3.1**  
Pay Telephones **11.1.7, 11.1.11**  
Shower Controls **10.1.4**  
Slot Design **14.1.6**  
Vending Machines **14.1.1**  
Urinals **8.1.12**

## V

Vending Machines – Controls **14.1.3, 14.1.4, 14.1.5**  
Location **5.1.3, 14.1.1**  
Illumination **14.1.6**  
Vestibules **4.1.5**  
Violations, Enforcement **1.1.5**  
Visual Aid definition **1.1.3**  
Visual Emergency Warning definition **1.1.3**  
Health Facilities **16.4.3**  
Hotels, Motels **16.2.5**  
Visual Impairment, Severe **2.8**

## W

Walk definition **1.1.3**  
Walks, Sidewalks **3.2 et seq.**  
Exterior Circulation Routes **3.1 et seq.**  
Slope of **3.2.4, 3.2.5, 3.2.6**  
Width **3.2.1**  
Walking Aid definition **1.1.3**  
Walking Disabilities **2.2**  
Warning Signals and Alarms, Emergency **12.2 et seq.**  
Elevator Communication **7.1.17**

Emergency Exit, Manual Door Openers **4.2.7, 12.2.3, 17.1.6**  
Fire Alarm Devices **12.2.5, 14.1.2**  
Health Facilities **16.4.3**  
Hotels, Motels **16.2.5**  
Remodeling **17.1.6**  
Water Closets **8.1.7**  
Remodeling **Table 17.1.2d, Table 17.1.3d, Table 17.1.4c**  
Water Controls – Faucets **8.1.10, 14.4.3**  
Showers **10.1.4**  
Water Coolers **9.1 et al**  
Water Temperature – Lavatories **8.1.11**  
Insulation on Pipes **14.4.1**  
Showers **10.1.5**  
Wheelchair Users **2.3 et seq.**  
Dimensions of Wheelchairs **2.3.1**  
Reaching From a Wheelchair **2.3.3**  
Space Requirements for Maneuvering **2.3.2**  
Space Requirements for Passing **2.3.4**  
Worship, Places of see Public Building definition **1.1.3**